



FERRAGENS
PARAFUSOS
FERRAMENTAS
QUÍMICOS



FERRAGENS

▶ ABRAÇADEIRA DE NYLON PRETA



- Indicada para fixar e organizar fios, cabos, entre outros.
 - Também conhecida no mercado como: enforca gato, fita de nylon e abraçadeira plástica. A abraçadeira de nylon é indicada para uso interno e externo.
 - Produzida em nylon 6.6 que proporciona maior resistência à tração.
- Além de proteção U.V. (resistente à radiação ultravioleta), permite o uso em ambientes internos ou externos.
- Material: nylon 6.6

CODIGO	MEDIDA
115	10CM X 2,50MM
116	15CM X 3,6MM
117	20CM X 2,5MM
118	25CM X 4,80MM
119	30CM X 4,80MM
120	40CM X 4,80MM
121	40CM X 7,6MM
122	65CM X 12,00MM

▶ ABRAÇADEIRA DE NYLON BRANCA



- Indicada para fixar e organizar fios, cabos, entre outros.
 - Também conhecida no mercado como: enforca gato, fita de nylon e abraçadeira plástica. A abraçadeira de nylon é indicada para uso interno e externo.
 - Produzida em nylon 6.6 que proporciona maior resistência à tração.
- Além de proteção U.V. (resistente à radiação ultravioleta), permite o uso em ambientes internos ou externos.
- Material: nylon 6.6

CODIGO	MEDIDA
123	10CM X 2,50MM
124	15CM X 3,6MM
125	20CM X 2,5MM
126	30CM X 4,80MM
127	40CM X 4,80MM
128	40CM X 7,60MM

▶ ABRAÇADEIRA DE NYLON PARA FIXAÇÃO DO CHICOTE AO CHASSIS



- Produto destinado para fixação de chicotes, cabos, fios e mangueiras ao longo dos chassis (caminhão e ônibus).
 - Produzida em nylon 6.6 que proporciona maior resistência à tração.
- Além de proteção U.V. (resistente à radiação ultravioleta), permite o uso em ambientes internos ou externos.
- Material: nylon 6.6

CODIGO	MEDIDA
130	13,4CM X 4,80MM

▶ ABRAÇADEIRA DE NYLON PARA CHASSIS



- Produto destinado para fixação de chicotes, cabos, fios e mangueiras ao longo dos chassis (caminhão e ônibus).
 - Produzida em nylon 6.6 que proporciona maior resistência à tração.
- Além de proteção U.V. (resistente à radiação ultravioleta), permite o uso em ambientes internos ou externos.
- Material: nylon 6.6

CODIGO	MEDIDA
129	30CM X 6,00MM

▶ FIXADOR ADESIVO PARA ABRAÇADEIRA DE NYLON



- Produto destinado para fixação de abraçadeiras de nylon.
 - Produzida em nylon 6.6 que proporciona maior resistência à tração.
- Além de proteção U.V. (resistente à radiação ultravioleta), permite o uso em ambientes internos ou externos.
- Material: nylon 6.6

CODIGO	APLICAÇÃO
2213	FIXAR ABRAÇADEIRA DE NYLON



▶ ABRAÇADEIRA ROSCA SEM FIM FITA 9MM



- Indicada para fixação de mangueiras
- Possui acabamento zincado que proporciona maior resistência à corrosão/oxidação
- Material: aço carbono
- Acabamento: zincado



CODIGO	MEDIDA
10687	9X13MM (3/8X1/2")
10688	12X16MM (1/2X5/8')
10689	13X19MM (1/2X3/4")
10690	14X22MM (9/16X7/8")
10691	19X27MM (3/4X1")
10692	22X32MM (3/4X1.1/4')
10693	25X38MM (1X1.1/2")
10694	32X44MM (1.1/4X1.3/4")
10695	38X51MM (1.1/2X2")
10696	44X57MM (1.3/4X2.1/4")
10697	51X64MM (2X2.1/2")
10698	57X76MM (2.1/2X3")
10699	64X83MM (2.1/2X3.1/4")
10700	70X89MM (2.3/4X3.1/2")
10701	76X95MM (3X3.3/4")
10702	89X108MM (3.1/2X4.1/4")
10703	102X121MM (4.1/4X4.3/4")

▶ ABRAÇADEIRA ROSCA SEM FIM FITA 14MM



- Indicada para fixação de mangueiras
- Possui acabamento zincado que proporciona maior resistência à corrosão/oxidação
- Material: aço carbono
- Acabamento: zincado



CODIGO	MEDIDA
10704	14X22MM (5/8X7/8")
10705	19X27MM (3/4X11/16')
10706	22X32MM (3/4X1.1/4")
10707	25X38MM (1X1.1/2")
10708	32X44MM (1.1/4X1.3/4")
10709	38X51MM (1.1/2X2")
10710	44X57MM (3/4X2.1/4")
10711	51X64MM (2X2.1/2")
10712	57X76MM (2.1/2X3")
10713	64X83MM (2.1/2X3.1/4")
10714	70X89MM (2.3/4X3.1/2")
10715	76X95MM (3X3/4")
10716	83X102MM (3.1/2X4)
10717	89X108MM (3.3/4X4.1/4)
10718	102X121MM (4.1/4X4.3/4)
10719	114X133MM (4.1/2X5.1/4)
10720	127X146MM (5X5.3/4)

KIT ABRAÇADEIRAS ROSCA SEM FIM



KIT ABRAÇADEIRAS ROSCA SEM FIM FITA 9MM 10775

CODIGO	MEDIDA	QUANTIDADE
10687	9X13MM (3/8X1/2")	30
10688	12X16MM (1/2X5/8')	20
10689	13X19MM (1/2X3/4")	20
10690	14X22MM (9/16X7/8")	20
10691	19X27MM (3/4X1")	20
10692	22X32MM (3/4X1.1/4')	20
10693	25X38MM (1X1.1/2")	0
10694	32X44MM (1.1/4X1.3/4")	10
10695	38X51MM (1.1/2X2")	10
10696	44X57MM (1.3/4X2.1/4')	10
10661	EXPOSITOR DE ABRAÇADEIRAS	1

KIT ABRAÇADEIRAS ROSCA SEM FIM FITA 14MM 10776

CODIGO	MEDIDA	QUANTIDADE
10704	14X22MM (5/8X7/8")	10
10705	19X27MM (3/4X11/16')	10
10706	22X32MM (3/4X1.1/4")	10
10707	25X38MM (1X1.1/2")	10
10708	32X44MM (1.1/4X1.3/4")	10
10709	38X51MM (1.1/2X2")	10
10710	44X57MM (3/4X2.1/4")	10
10711	51X64MM (2X2.1/2")	10
10712	57X76MM (2.1/2X3")	10
10713	64X83MM (2.1/2X3.1/4")	10
10714	70X89MM (2.3/4X3.1/2")	10
10715	76X95MM (3X3/4")	10
10661	EXPOSITOR DE ABRAÇADEIRAS	1

▶ ABRAÇADEIRA ROSCA SEM FIM FITA 9MM



- Indicada para fixação de mangueiras
- Possui acabamento zincado que proporciona maior resistência à corrosão/oxidação
- Material: aço carbono
- Acabamento: zincado



▶ ABRAÇADEIRA ROSCA SEM FIM FITA 13,5MM



- Indicada para fixação de mangueiras
- Possui acabamento zincado que proporciona maior resistência à corrosão/oxidação
- Material: aço carbono
- Acabamento: zincado



CODIGO	MEDIDA
2	9X13MM (3/8X1/2")
3	12X16MM (1/2X5/8')
4	13X19MM (1/2X3/4")
5	14X22MM (9/16X7/8")
6	19X27MM (3/4X1")
7	22X32MM (3/4X1.1/4')
8	25X38MM (1X1.1/2")
9	32X44MM (1.1/4X1.3/4")
10	38X51MM (1.1/2X2")
11	44X57MM (1.3/4X2.1/4')
12	51X64MM (2X2.1/2")
13	57X76MM (2.1/2X3")
14	64X83MM (2.1/2X3.1/4")
15	70X89MM (2.3/4X3.1/2")
16	76X95MM (3X3.3/4")
17	89X108MM (3.1/2X4.1/4")
18	102X121MM (4.1/4X4.3/4")

CODIGO	MEDIDA
19	14X22MM (5/8X7/8")
20	19X27MM (3/4X11/16')
21	22X32MM (3/4X1.1/4")
22	25X38MM (1X1.1/2")
23	32X44MM (1.1/4X1.3/4")
24	38X51MM (1.1/2X2")
25	44X57MM (3/4X2.1/4")
26	51X64MM (2X2.1/2')
27	57X76MM (2.1/2X3')
28	64X83MM (2.1/2X3.1/4")
29	70X89MM (2.3/4X3.1/2")
30	76X95MM (3X3/4")
31	83X102MM (3.1/2X4)
32	89X108MM (3.3/4X4.1/4)
33	102X121MM (4.1/4X4.3/4)
34	114X133MM (4.1/2X5.1/4)
35	127X146MM (5X5.3/4)

KIT ABRAÇADEIRAS ROSCA SEM FIM



KIT ABRAÇADEIRAS ROSCA SEM FIM FITA 9MM **10626**

CODIGO	MEDIDA	QUANTIDADE
2	9X13MM (3/8X1/2")	30
3	12X16MM (1/2X5/8')	20
4	13X19MM (1/2X3/4")	20
5	14X22MM (9/16X7/8")	20
6	19X27MM (3/4X1")	20
7	22X32MM (3/4X1.1/4')	20
8	25X38MM (1X1.1/2")	10
9	32X44MM (1.1/4X1.3/4")	10
10	38X51MM (1.1/2X2")	10
11	44X57MM (1.3/4X2.1/4')	10
10661	EXPOSITOR DE ABRAÇADEIRAS	1

KIT ABRAÇADEIRAS ROSCA SEM FIM FITA 13,5MM **10627**

CODIGO	MEDIDA	QUANTIDADE
19	14X22MM (5/8X7/8")	10
20	19X27MM (3/4X11/16')	10
21	22X32MM (3/4X1.1/4")	10
22	25X38MM (1X1.1/2")	10
23	32X44MM (1.1/4X1.3/4")	10
24	38X51MM (1.1/2X2")	10
25	44X57MM (3/4X2.1/4")	10
26	51X64MM (2X2.1/2')	10
27	57X76MM (2.1/2X3')	10
28	64X83MM (2.1/2X3.1/4")	10
29	70X89MM (2.3/4X3.1/2")	10
30	76X95MM (3X3/4")	10
10661	EXPOSITOR DE ABRAÇADEIRAS	1

▶ ABRAÇADEIRA PARA MANGOTE FITA 21MM



- Indicada para fixação em mangotes ou tubos de material rígido
- Possui acabamento zincado que proporciona maior resistência à corrosão/oxidação
- Material: aço carbono
- Acabamento: zincado

CODIGO	MEDIDA
67	15X20MM - 3/4"
68	20X25MM - 7/8"
69	29X32MM - 1"
70	35X40MM - 1.1/4"
71	39X47MM - 1.1/2"
72	48X56MM - 1.3/4"
73	54X62MM - 2"
74	67X75MM - 2.1/2"
75	79X87MM - 3"
76	99X107MM - 4"
77	105X117MM - 4.1/4"



▶ ABRAÇADEIRA PARA MANGOTE FITA 32MM



- Indicada para fixação em mangotes ou tubos de material rígido
- Possui acabamento zincado que proporciona maior resistência à corrosão/oxidação
- Material: aço carbono
- Acabamento: zincado

CODIGO	MEDIDA
78	29X32MM - 1"
79	35X40MM - 1.1/4"
80	39X47MM - 1.1/2"
81	48X56MM - 1.3/4"
82	54X62MM - 2"
83	61X69MM - 2.1/4"
84	67X75MM - 2.1/2"
85	73X81MM - 2.3/4"
86	79X87MM - 3"
87	92X100MM - 3.1/2"
88	99X107MM - 4"
89	105X117MM - 4.1/4"
90	117X129MM - 4.3/4"
91	124X136MM - 5"
92	149X161MM - 6"
93	162X174MM - 6.1/2"
94	187X199MM - 7"
95	213X225MM - 8"

KIT ABRAÇADEIRAS PARA MANGOTE



KIT ABRAÇADEIRAS PARA MANGOTE FITA 21MM **10628**

CODIGO	MEDIDA	QUANTIDADE
67	15X20MM - 3/4"	10
68	20X25MM - 7/8"	10
69	29X32MM - 1"	10
70	35X40MM - 1.1/4"	5
71	39X47MM - 1.1/2"	5
72	48X56MM - 1.3/4"	5
73	54X62MM - 2"	5
74	67X75MM - 2.1/2"	5
75	79X87MM - 3"	5
76	99X107MM - 4"	5
10661	EXPOSITOR DE ABRAÇADEIRAS	1

KIT ABRAÇADEIRAS PARA MANGOTE FITA 32MM **10629**

CODIGO	MEDIDA	QUANTIDADE
78	29X32MM - 1"	5
79	35X40MM - 1.1/4"	5
80	39X47MM - 1.1/2"	5
81	48X56MM - 1.3/4"	5
82	54X62MM - 2"	5
83	61X69MM - 2.1/4"	5
84	67X75MM - 2.1/2"	5
85	73X81MM - 2.3/4"	5
86	79X87MM - 3"	5
87	92X100MM - 3.1/2"	5
88	99X107MM - 4"	5
10661	EXPOSITOR DE ABRAÇADEIRAS	1

▶ ABRAÇADEIRA TIPO NORMA



- Desenvolvida para uma perfeita adaptação ao perfil da mangueira. É indicada para uso em locais com baixa pressão como, por exemplo, mangueiras de combustíveis.
- Material: aço carbono
- Acabamento: zincado

CODIGO	MEDIDA
42	6X8MM
43	7X9MM
44	8X10MM
45	9X11MM
46	10X12MM
47	11X13MM
48	12X14MM
49	13X15MM
50	14X16MM
9560	15X17MM
51	16X19MM

▶ ABRAÇADEIRA INOX PARA MANGUEIRA



- Utilizada para mangueira de combustível, em sistemas hidráulicos e sistemas de injeções submetidos a altas pressões. Apresenta circularidade regular e constante distribuição das forças radiais.
- De fácil aplicação.
- Material: aço inoxidável

CODIGO	MEDIDA
52	8,7MM
53	10MM
54	11,3MM
55	12,3MM
56	13,5MM
57	14,5MM
58	15,3MM
59	15,7MM
60	18,0MM

▶ ABRAÇADEIRA TIPO MOLA



- As abraçadeiras do tipo MOLA oferecem tensão constante, e por isso são recomendadas para aplicações onde existem variações de temperatura e pressão, muito utilizada em sistemas de arrefecimento.
- Material: aço cromo vanádio

CODIGO	MEDIDA
61	14MM
62	20MM
63	23MM
64	25MM
65	32MM
66	40MM

KIT ABRAÇADEIRAS AUTOMOTIVAS

KIT ABRAÇADEIRAS AUTOMOTIVAS 10630

CODIGO	MEDIDA	QUANTIDADE
42	6X8MM TIPO NORMA	20
44	8X10MM TIPO NORMA	20
46	10X12MM TIPO NORMA	20
48	12X14MM TIPO NORMA	20
50	14X16MM TIPO NORMA	10
51	16X19MM TIPO NORMA	10
62	20MM TIPO MOLA	10
63	23MM TIPO MOLA	10
64	25MM TIPO MOLA	10
65	32MM TIPO MOLA	10
66	40MM TIPO MOLA	10
53	10MM P/ MANGUEIRA	20
54	11,3MM P/ MANGUEIRA	20
55	12,3MM P/ MANGUEIRA	20
56	13,5MM P/ MANGUEIRA	20
57	14,5MM P/ MANGUEIRA	10
59	15,7MM P/ MANGUEIRA	10
10661	EXPOSITOR DE ABRAÇADEIRAS	1



▶ ABRAÇADEIRA BORBOLETA FITA 9MM



- Indicada para fixação de mangueiras
- Produzida em aço carbono, proporcionando maior resistência e durabilidade.
- Possui acabamento zincado, que aumenta a proteção contra oxidação/corrosão e borboleta, que facilita o aperto e desaperto da abraçadeira.
- Material: aço carbono
- Acabamento: zincado

CODIGO	MEDIDA
36	8X10MM
37	9X13MM
38	12X16MM
39	13X19MM
40	14X22MM
41	19X27MM

▶ ABRAÇADEIRA UNIVERSAL PARA JUNTA HOMOCINETICA



- Foi desenvolvida para atender situações em que o aplicador necessita de diâmetros especiais para aplicação nas Juntas Homocinéticas
- Material: aço carbono

CODIGO	MEDIDA
104	7MMX245MM
105	7MMX320MM
106	7MMX450MM
107	9MMX245MM
108	9MMX320MM
109	9MMX450MM

▶ ABRAÇADEIRA REVESTIDA DE BORRACHA



- Projetadas para fixação de tubos ou mangueiras em estruturas sujeitas à vibração. Seu revestimento de borracha protege os componentes do contato direto. Utilizadas em caminhões, ônibus, automóveis e instalações industriais. Não deve ser utilizada de aperto.
- Material: aço carbono

CODIGO	MEDIDA
96	6MM
97	10MM
98	13MM
99	16MM
100	22MM
101	25MM
102	35MM
103	45MM

▶ ABRAÇADEIRA LACRE AUTO TAVANTE



- Este modelo funciona como um "lacre" sem retorno, é uma abraçadeira auto travante. É utilizada em aplicações muito amplas que necessitam fixação, amarração. Alguns exemplos de aplicação, são coifas automotivas, homocinéticas, caixa de direção, caixa de marcha, amarração de fios e cabos, fixação de placas, entre outros. Tem importante função como Abraçadeira Anti Furto de cabos de vias aéreas de empresas de telefonia, elétrica, tv a cabo e internet, quando amarra o cabo junto à cordoalha de aço, impedindo assim o furto.
- Material: aço carbono

CODIGO	MEDIDA
110	5MMX201MM
111	5MMX400MM
112	9MMX201MM
113	9MMX400MM

▶ CHAVE PARA APERTO DE ABRAÇADEIRA LACRE



CODIGO	APLICAÇÃO
114	ABRAÇADEIRA LACRE AUTO TRAVANTE



▶ ABRAÇADEIRA TUCHO



- Aplicações industriais e veiculares. Projetada para mangueiras flexíveis de baixa espessura, possui excelente desempenho de durabilidade e resistência. Apresenta bordas conformadas visando garantir a integridade das mangueiras e do sistema.
- Material: Aço inoxidável AISI 5400
- Torque máximo de aperto: 10 Nm
- Torque recomendado de aplicação: 8 Nm
- Largura da fita: 20 mm
- Espessura da fita: 0,7 mm

CODIGO	MEDIDA
9207	24X30MM (1X1.3/16)
9208	28X34MM (1.1/8X1.3/8)
9209	32X38MM (1.5/16X1.1/2)
9210	36X42MM (1.7/16X1.11/16)
9211	40X46MM (1.5/8X1.13/16)
9212	44X50MM (1.3/4X2)
9213	48X54MM (1.15/16X2.3/16)
9214	52X58MM (2.1/16X2.5/16)
9215	57X65MM (2.1/4X2.5/16)
9216	63X71MM (2.1/2X2.13/16)
9279	68X77MM (2.11/16X3.1/16)
9218	74X83MM (2.15/16X3.5/16)
9219	80X89MM (3.3/16X3.9/16)
9220	83X92MM (3.5/16X3.5/8)
9221	86X95MM (3.7/16X3.3/4)
9222	92X101MM (3.5/8X4)
9223	96X108MM (3.13/16X4.5/16)
9224	104X116MM (4.1/8X4.5/8)
9225	112X124MM (4.7/16X4.15/16)
9226	120X132MM (4.3/4X5.1/4)
9227	128X140MM (5.1/16X5.9/16)
9228	136X148MM (5.3/8X5.7/8)
9229	146X158MM (5.3/4X6.1/4)

▶ ABRAÇADEIRA TUCHO MOLA



- Oferece o mesmo padrão de durabilidade, torque e qualidade das abraçadeiras Tucho T, proporcionando um aperto constante e compensando, através da mola, variações no diâmetro devido a mudanças de temperatura ou acomodação da mangueira.
- Apresenta bordas conformadas visando garantir a integridade das mangueiras e do sistema.
- Material: Aço inoxidável AISI 5400
- Torque máximo de aperto: 10 Nm
- Torque recomendado de aplicação: 8 Nm
- Largura da fita: 20 mm
- Espessura da fita: 0,7 mm

CODIGO	MEDIDA
9230	24X30MM (1X1.3/16)
9231	28X34MM (1.1/8X1.3/8)
9232	32X38MM (1.5/16X1.1/2)
9233	36X42MM (1.7/16X1.11/16)
9234	40X46MM (1.5/8X1.13/16)
9235	44X50MM (1.3/4X2)
9236	48X54MM (1.15/16X2.3/16)
9237	52X58MM (2.1/16X2.5/16)
9238	57X65MM (2.1/4X2.9/16)
9239	63X71MM (2.1/2X2.13/16)
9240	68X77MM (2.11/16X3.1/16)
9241	74X83MM (2.15/16X3.5/16)
9242	80X89MM (3.3/16X3.9/16)
9243	83X92MM (3.5/16X3.5/8)
9244	86X95MM (3.7/16X3.3/4)
9245	92X101MM (3.5/8X4)
9246	96X108MM (3.13/16X4.5/16)
9247	104X116MM (4.1/8X4.5/8)
9248	112X124MM (4.7/16X4.15/16)
9249	120X132MM (4.3/4X5.1/4)
9250	128X140MM (5.1/16X5.9/16)
9251	136X148MM (5.3/8X5.7/8)
9252	146X158MM (5.3/4X6.1/4)



METAL MATRIX

A B R A Ç A D E I R A S

▶ TUCHO MECÂNICO (BUCHA PRISONEIRO CARCACA)

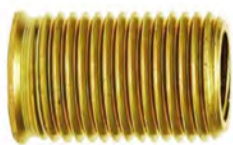

Descrição do produto

Tucho mecânico em aço carbono para recondicionamento de roscas diversas.

Características

- Material em Aço carbono, com acabamento bicromatizado.

Modo de usar

- Alongar o furo a ser recondicionado com o diâmetro indicado na tabela.
- Utilizar o macho com a rosca externa específica.
- Colocar o tucho no furo a ser recondicionado e rosquear manualmente ou com auxílio de parafuso.

CODIGO	DIMENSÕES	INTERNO	EXTERNO	COMPRIIMENTO	MACHO	BROCA
8252	4x7x8	4x0.70	7x1.00	8	10541	10427
8231	5x7x16	5x0.80	7x1.00	16	10541	10427
8232	5x8x16	5x0.80	8x1.25	16	10542	10429
8233	6x8x16	6x1.00	8x1.25	16	10542	10429
8234	6x10x16	6x1.00	10x1.50	16	10543	10433
8235	7x10x16	7x1.00	10x1.50	16	10543	10433
8237	8x10x20	8x1.25	10x1.00	20	10551	10433
8236	8x10x16	8x1.25	10x1.25	16	10552	10433
8238	8x10x25	8x1.25	10x1.25	25	10552	10433
8240	8x12x25	8x1.25	12x1.25	25	10553	10436
8239	8x12x16	8x1.25	12x1.50	16	10554	10436
8241	8x14x26	8x1.25	14x1.50	26	10557	10438
8242	8x16x26	8x1.25	16x1.50	26	10559	10440
8243	8x7/16x20	8x1.25	7/16x20	20	10577	10435
8245	10x12x20	10x1.00	12x1.25	20	10553	10436
8246	10x14x15	10x1.00	14x1.50	15	10557	10438
8248	10x14x26	10x1.25	14x1.50	16	10557	10438
8247	10x14x25	10x1.50	14x1.50	25	10557	10438
8249	10x16x25	10x1.25	16x1.50	25	10559	10440
8250	10x16x26	10x1.50	16x1.50	26	10559	10440
8244	12X14X20	12X1,25	14X1,25	20	10556	10438
8251	12x16x20	12x1.25	16x1.50	20	10559	10440
8255	14x18x16	14x1,25	18x1,50	16	10560	10442
8256	14x18x16	14x1,25	18x1,50	16	10560	10442
8253	14x18x24	14x1.50	18x1.50	24	10560	10442
8254	16x20x26	16x1.50	20x1.50	26	10561	10444

▶ SUPRESSOR VELA SEXTAVADO VOLKSWAGEN



- MACHO : 10560
- BROCA: 10442

▶ SUPRESSOR VELA VOLKSWAGEN



- MACHO : 10560
- BROCA: 10442

CODIGO	MEDIDA
8255	Int.14x1,25 Ext.18x1,50 Comp.16

CODIGO	MEDIDA
8256	Int.14x1,25 Ext.18x1,50 Comp.16

PRISIONEIRO



Descrição do produto

O prisioneiro é uma haste de formato reto, sem cabeça, que possui rosca nas suas duas extremidades. Além disso, apresenta um corpo liso na parte central de sua haste, que serve de apoio no momento de sua aplicação.

CODIGO	DIMENSÕES	APLICAÇÃO	CODIGO	DIMENSÕES	APLICAÇÃO
9688	6X6X23		9666	10X11X204	
9682	6X6X28		9665	10X11X240	
8201	6X6X30		9664	10X11X250	
8202	6X6X35		9663	10X12X137	
8203	6X6X40		9662	10X12X188	
9670	6X8X23		9661	10X12X204	
9669	6X8X28		9660	10X12X240	
8204	6X8X31	ESCAPE FUSCA/VW	9659	10X12X250	
9668	6X8X40		9658	5/16x40	
8205	7X7X35		8225	3/8-UNFx3/8-UNFx1.3/4	ESCAPE D-20 93/96 F-1000 MWM
8206	7X7X40		8226	3/8-UNCx3/8-UNFx1.3/4	ESCAPE D-20 85/92
9681	7X7X70		8227	3/8-UNCx3/8-UNCx1.3/4	ESCAPE C-10/ OPALA
9680	8X8X27		9672	3/8x3/8x35	CAMARA COMBUSTÃO
8207	8X8X35	ESCAPE VW	9672	3/8x3/8x43	CAMARA COMBUSTÃO
8208	8X8X38	ESCAPE FIAT			
8209	8X8X40	CARÇAÇA MOTOR/ COLETOR VW			
8210	8X8X42	ESCAPE GM			
8211	8X8X45	ESCAPE/ TURBINA			
8212	8X8X46	EIXO BALANCIM			
8213	8X8X50	CARÇAÇA FUSCA			
9679	8X8X58				
9678	8X8X75	C/ RESSALTO			
8214	8X8X82	CABEÇOTE/ BICO RANGER 3.0			
9677	8X8X196				
9676	8X8X223				
9675	8X8X231				
8215	8X10X31	ESCAPE VW			
8216	8X10X35	ESCAPE VW			
8217	8X10X40	CARÇAÇA MOTOR			
8218	8X10X50	CARÇAÇA MOTOR SOB MEDIDA			
9657	8X10X60				
9656	8X10X97				
9655	8X8X180				
8219	10X10X40	BOMBA DAGUA AP			
8220	10X10X45	MOTOR ARRANQUE S/ RESSALTO			
8221	10X10X45	TURBINA C/ RESSALTO			
8222	10X10X52				
9674	10X10X62				
8224	10X10X72				
9673	10X10X112				
9667	10X11X166				

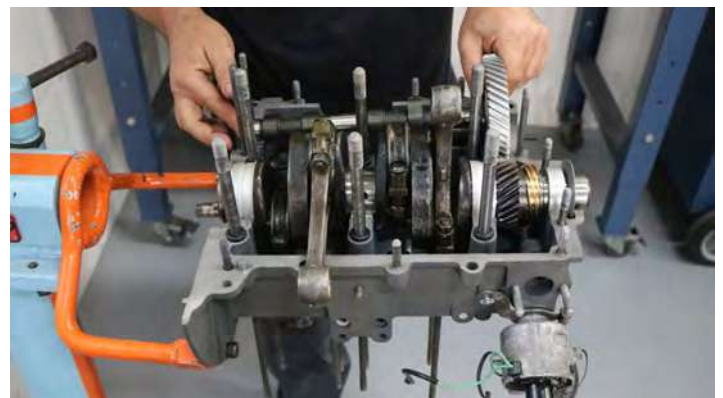
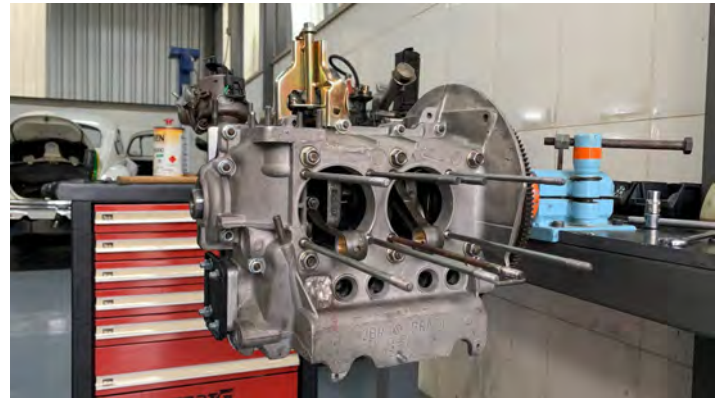

▶ FUSÍVEL LÂMINA



CODIGO	AMPERES / COR
10874	5A Laranja
10875	7,5A Marrom
10876	10A Vermelho
10877	15A Azul
10878	20A Amarelo
10879	25A Cristal
10880	30A Verde
10881	40A Ambar

▶ FUSÍVEL MINI-LÂMINA



CODIGO	AMPERES / COR
10869	5A Laranja
10870	10A Vermelho
10871	15A Azul
10872	20A Amarelo
10873	25A Cristal

▶ FUSÍVEL MINI LÂMINA PERFIL BAIXO



• APLICAÇÃO: VOLKSWAGEN/
FIAT/ GM/ TOYOTA/ HYUNDAI/
HONDA/ NISSAN

CODIGO	AMPERES
10912	5A Laranja
10913	7,5A Marrom
10914	10A Vermelho
10915	15A Azul
10916	20A Amarelo
10917	25A Cristal
10918	30A Verde

▶ FUSÍVEL LÂMINA MAX



CODIGO	AMPERES / COR
10882	20A Amarelo
10883	30A Verde
10884	40A Laranja
10885	50A Vermelho
10886	60A Azul

▶ FUSÍVEL LÂMINA MICRO-2



• APLICAÇÃO: FORD/ RENAULT
14/... FIAT/ NISSAN

CODIGO	AMPERES
10919	5A Laranja
10920	7,5A Marrom
10921	10A Vermelho
10922	15A Azul
10923	20A Amarelo
10924	25A Transp.
10925	30A Verde

▶ FUSÍVEL LÂMINA MICRO-3



• APLICAÇÃO: FORD 14/...

CODIGO	AMPERES
10926	5A Laranja
10927	7,5A Marrom
10928	10A Vermelho
10929	15A Azul

▶ FUSÍVEL MAXI LÂMINA PLUS



• APLICAÇÃO: FIAT /
JEEP 20/...

CODIGO	AMPERES
10954	20A Amarelo
10955	25A Branco
10956	30A Verde Claro
10957	35A Verde Escuro
10958	40A Laranja
10959	50A Vermelho
10960	60A Azul

▶ PORTA FUSÍVEL



CODIGO	AMPERES
10930	PORTA FUSIVEL LAMINA FIO-1,50MM
10931	PORTA FUSIVEL LAMINA FIO-2,5MM
10932	PORTA FUSIVEL MINI-LAMINA FIO-1,50MM

▶ FUSÍVEL MEGA FÊMEA



• APLICAÇÃO: FORD/ TOYOTA/
HONDA/ HYUNDAI/ MITSUBISHI/
SUZUKI

CODIGO	AMPERES
10933	20A Azul Claro/ Branco
10934	30A Rosa
10935	40A Verde
10936	50A Vermelho
10937	60A Amarelo

▶ FUSÍVEL MEGA MACHO



• APLICAÇÃO: VOLKSWAGEN/ FORD/ TOYOTA/ HYUNDAI/ MITSUBISHI/ VOLVO/ JEEP/ NISSAN

CODIGO	AMPERES
10938	20A Azul Claro/ Branco
10939	30A Rosa
10940	40A Verde
10941	50A Vermelho
10942	60A Amarelo

▶ FUSÍVEL MIDI FÊMEA



• APLICAÇÃO: FORD/ NISSAN/ TOYOTA/ KIA/ SUBARU

CODIGO	AMPERES
10893	20A (16X27X12) Azul Claro
10894	30A (16X27X12) Rosa
10895	40A (16X27X12) Verde
10896	50A (16X27X12) Vermelho
10897	60A (16X27X12) Amarelo

▶ FUSÍVEL MIDI FÊMEA PERFIL BAIXO



• APLICAÇÃO: FORD/ GM/ TOYOTA

CODIGO	AMPERES
10906	20A (14X16X12) Azul Claro
10907	25A (14X16X12) Branco
10908	30A (14X16X12) Rosa
10909	40A (14X16X12) Verde
10910	50A (14X16X12) Vermelho
10911	60A (14X16X12) Amarelo

▶ FUSÍVEL MIDI FÊMEA JCASE STANDARD



• APLICAÇÃO: FORD/ TOYOTA/ JEEP/ HONDA/ CHRYSLER

CODIGO	AMPERES
10898	20A (14X24X12) Azul Claro
10899	25A (14X24X12) Branco
10900	30A (14X24X12) Rosa
10901	40A (14X24X12) Verde
10902	50A (14X24X12) Vermelho
10903	60A (14X24X12) Amarelo
10904	70A (14X24X12) Marrom
10905	80A (14X24X12) Preto

▶ FUSÍVEL MIDI FÊMEA MCASE



• APLICAÇÃO: NOVO KA/ NOVA ECOSPORT

CODIGO	AMPERES
10943	20A Azul Claro
10944	25A Bege
10945	30A Rosa
10946	40A Verde

▶ FUSÍVEL MIDI FÊMEA MCASE FENDA PLUS



• APLICAÇÃO: FORD

CODIGO	AMPERES
10947	15A Cinza
10948	20A Azul
10949	25A Bege
10950	30A Rosa
10951	40A Verde
10952	50A Vermelho
10953	60A Amarelo

▶ FUSÍVEL VIDRO



• APLICAÇÃO: CHEVROLET, FORD, AUTOS, PICK-UPS E CAMINHÕES ATÉ 1984, TRATORES, CATERPILLAR, CBT, MASSEY FERGUSON, VALMET

CODIGO	AMPERES
10887	10A (31,75X6,35)
10888	15A (31,75X6,35)
10889	20A (31,75X6,35)

▶ FUSÍVEL VIDRO PARA RÁDIO



• APLICAÇÃO: UTILIZADOS EM RÁDIOS, APARELHOS ELETRÔNICOS E EQUIPAMENTOS ELETRO-ELETRÔNICOS

CODIGO	AMPERES
10890	2A (20,00X5,00)
10891	3A (20,00X5,00)
10892	5A (20,00X5,00)



▶ **TERMINAL PARA POLO POSITIVO DA BATERIA SAPINHO**



Descrição do produto:
Terminal de bateria destinado a aplicação em automóveis, caminhões, ônibus, máquinas agrícolas, no-breaks e geradores.

Características

- Produzido em latão.
- Disponível para cabos de ate 35mm.
- Acompanha parafuso de fixação. Terminal Negativo, Universal e de Alojamento.

Aplicações

- Destinado à aplicação em automóveis, caminhões, ônibus, máquinas agrícolas, no-breaks e geradores.

Importante:

- Acompanha porca e parafuso.

CODIGO

CABO

10967

ATE 35MM

▶ **TERMINAL PARA POLO POSITIVO DA BATERIA SAPÃO**



Descrição do produto:
Terminal de bateria destinado a aplicação em automóveis, caminhões, ônibus, máquinas agrícolas, no-breaks e geradores.

Características

- Produzido em latão.
- Disponível para cabos de ate 70mm.
- Acompanha parafuso de fixação. Terminal Negativo, Universal e de Alojamento.

Aplicações

- Destinado à aplicação em automóveis, caminhões, ônibus, máquinas agrícolas, no-breaks e geradores.

Importante:

- Acompanha porca e parafuso.

CODIGO

CABO

10965

ATE 70MM

▶ **PONTEIRA TERMINAL DE BATERIA**



CODIGO

CABO

10969

25 a 35 MM

▶ **TERMINAL PARA POLO POSITIVO DA BATERIA SAPINHO NIQUELADO**



• Ideal para barcos

CODIGO

CABO

10974

ATE 35MM

▶ **TERMINAL PARA POLO POSITIVO DA BATERIA SAPÃO NIQUELADO**



• Ideal para barcos

CODIGO

CABO

10972

ATE 70MM

▶ **TERMINAL PARA POLO NEGATIVO DA BATERIA SAPINHO**



Descrição do produto:
Terminal de bateria destinado a aplicação em automóveis, caminhões, ônibus, máquinas agrícolas, no-breaks e geradores.

Características

- Produzido em latão.
- Disponível para cabos de ate 35mm.
- Acompanha parafuso de fixação. Terminal Negativo, Universal e de Alojamento.

Aplicações

- Destinado à aplicação em automóveis, caminhões, ônibus, máquinas agrícolas, no-breaks e geradores.

Importante:

- Acompanha porca e parafuso.

CODIGO

CABO

10968

ATE 35MM

▶ **TERMINAL PARA POLO NEGATIVO DA BATERIA SAPÃO**



Descrição do produto:
Terminal de bateria destinado a aplicação em automóveis, caminhões, ônibus, máquinas agrícolas, no-breaks e geradores.

Características

- Produzido em latão.
- Disponível para cabos de ate 70mm.
- Acompanha parafuso de fixação. Terminal Negativo, Universal e de Alojamento.

Aplicações

- Destinado à aplicação em automóveis, caminhões, ônibus, máquinas agrícolas, no-breaks e geradores.

Importante:

- Acompanha porca e parafuso.

CODIGO

CABO

10966

ATE 70MM

▶ **PONTEIRA TERMINAL DE BATERIA**



CODIGO

CABO

10970

50 MM

▶ **TERMINAL PARA POLO NEGATIVO DA BATERIA SAPINHO NIQUELADO**



• Ideal para barcos

CODIGO

CABO

10975

ATE 35MM

▶ **TERMINAL PARA POLO NEGATIVO DA BATERIA SAPÃO NIQUELADO**



• Ideal para barcos

CODIGO

CABO

10973

ATE 70MM



10976
EMENDA E LUVA PARA TERMINAL FEMEA 6,3MM

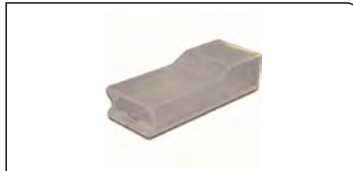

10977
EMENDA E LUVA PARA TERMINAL FEMEA 6,3MM C/ TRAVA



10978
EMENDA E LUVA PARA TERMINAL MACHO 6,3MM



10979
KIT CONECTOR 2 VIAS C/ TERMINAL 6,3MM MACHO/FEMEA



10980
KIT CONECTOR 5 VIAS P/ TERMINAL 6,3MM FEMEA P/ FIO 0,75MM ATE 2,50MM



10981
TERMINAL LATAO ENCAIXE FEMEA 2,8MM P/ FIO 0,50MM ATE 1,50MM C/ TRAVA MOSQUITINHO



10982
TERMINAL LATAO ENCAIXE FEMEA 6,3MM P/ FIO 0,75MM ATE 2,50MM C/ TRAVA



10983
TERMINAL LATAO ENCAIXE FEMEA 4,8MM P/ FIO 1,00MM S/ TRAVA



10984
TERMINAL LATAO ENCAIXE MACHO 6,3MM P/ FIO 1,00 ATE 2,50MM C/ TRAVA ESPADÃO



10985
TERMINAL LATAO OLHAL 3/16 P/ FIO 1,50MM



10986
TERMINAL LATAO OLHAL 1/4 P/ FIO 2,50MM



10987
TERMINAL LATAO OLHAL 5/16 P/ FIO 2,50MM



10988
TERMINAL LATAO OLHAL 3/8 - FIO 10,00MM



9756
CONECTOR DERIVACAO (SP1) VERMELHO 0,5 - 1,5MM



9757
CONECTOR DERIVACAO (SP2) AZUL 1,5 - 2,5MM



9758
CONECTOR DERIVACAO (SP5) AMARELO 4,00 - 6,00MM



▶ BUCHA DE PAREDE CINZA SEM ANEL



▶ BUCHA DE PAREDE CINZA COM ANEL

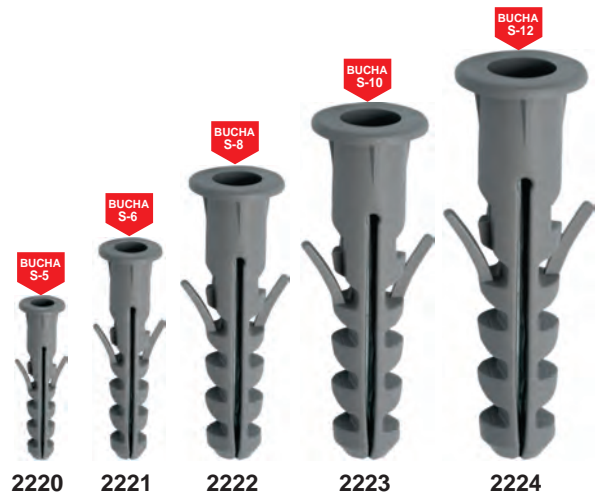

▶ BUCHA DE PAREDE BRANCA SEM ANEL



▶ BUCHA DE PAREDE BRANCA COM ANEL



▶ BUCHA DE NYLON SEM ANEL

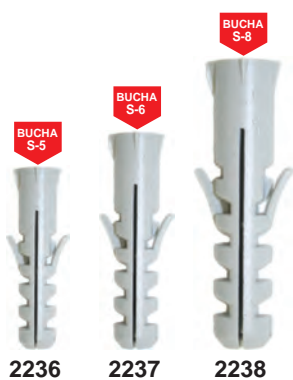

▶ BUCHA DE NYLON COM ANEL



▶ BUCHA DE MU COM ANEL



▶ BUCHA COM ANEL PARA TIJOLO FURADO



- *Ideal para uso em paredes de bloco oco, tijolo baiano, tijolo maciço, cimento, concreto.
- *Apresenta aletas e braços que fazem a bucha não girar dentro do furo.
- *Produzido em polietileno de alta densidade.
- *Utilizado com parafuso de rosca madeira ou auto atarraxante.
- *Utilizado para fixação de armários, prateleiras, quadros, acessórios de banheiro, etc.



1 Fazer um furo utilizando furadeira.

2 Colocar a Bucha no local do furo.

3 Parafusar o parafuso junto a Bucha.

4 Posição da Bucha em parede maciça. Mesmo que sinta facilidade em dar mais voltas no parafuso, não insista. A fixação esta correta.

5 Posição da Bucha em parede oca. Dar o mínimo de 6 voltas e no máximo de 8 voltas.

▶ BUCHA BRANCA PARA DRYWALL (PARA GESSO)

O comprimento do parafuso deve ser o comprimento da bucha mais espessura do objeto a ser fixado

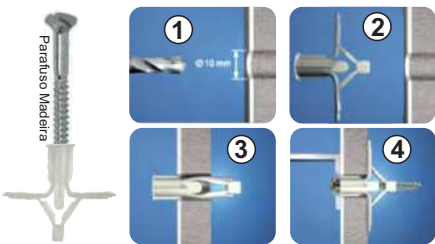

TIPOS DE FIXAÇÃO			
Bucha	FLY 2 Pequena	FLY 3 Média	FLY 4 Granda
Características			
Ø Furo (mm)	10	10	10
Espessura do material base (mm)	4 - 16	13 - 23	24 - 32
Ø Parafuso (mm)	4,0 - 4,5	4,0 - 4,5	4,0 - 4,5
Comprimento da Bucha (mm)	35	40	45
Carga Recomendada (Kgf)	Drywall 1/2" 10	Drywall 5/8" 15	Drywall 2x1/2" 15

BUCHA BRANCA DE FIXAÇÃO P/ DRYWALL/GESSO

- * Todos tipos de materiais ocios: Gesso, drywall, forro e etc.;
- * Parafusos madeira ou auto-atarraxante;
- * Travas anti-giro; evita que a bucha rode dentro do furo;
- * Produzida com poliamida 100% NYLON;
- * Disponível também na versão PEAD (plástico);
- * NYLON ou PEAD são comercializadas em 3 tamanhos.

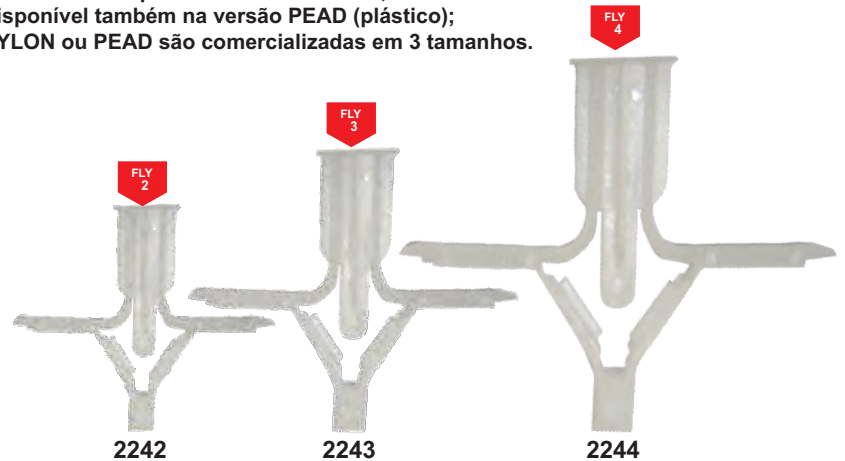

▶ BUCHA SFORBOLT

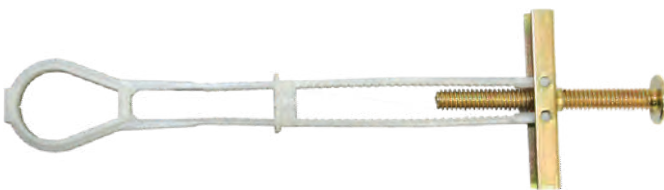

CODIGO **BUCHA** **BITOLA PARAFUSO**

2248

1/4"

1/4X2.1/2"

- *Para uso em paredes ocas, Drywall e gesso.
- *Ela se ajusta a diversas espessuras de parede..
- *Bucha feita para aguentar cargas altas.
- *Produzido em poliamida 6.0 de alta qualidade Nylon, o que faz com tenha uma durabilidade maior e a cabeça em aço carbono.
- *Utilizado para fixação de armários, prateleiras, etc.ão de armários, prateleiras, quadros, acessórios de banheiro, etc.

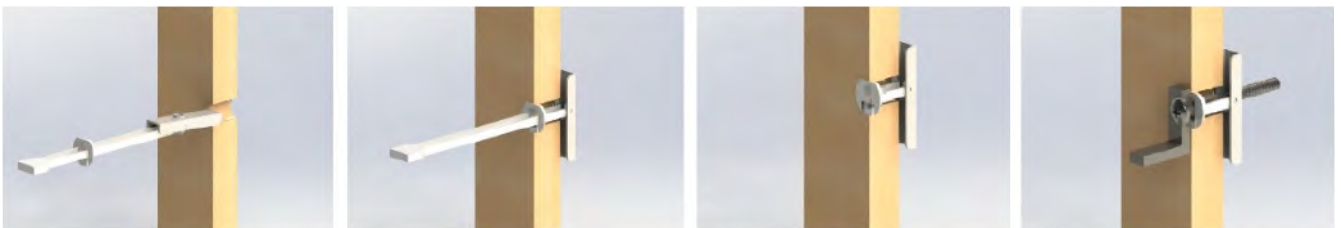

Fazer um furo de Ø 13mm e introduzir a bucha Sforbolt.

Com a bucha colocada deslizar o anel contra a parede.

Corte a haste da bucha.

Monte o suporte e aperte o parafuso.

▶ GANCHO ZINCADO



Formato do Gancho



- Indicado para a fixação em madeira (sem bucha para fixação), alvenaria e concreto (utilizar bucha para fixação), como suporte para os mais variados objetos.
- Possui acabamento zincado que aumenta a proteção contra oxidação/corrosão
- Material: aço carbono
- Acabamento: zincado

CODIGO	MEDIDA
2252	S-6
2253	S-8
2254	S-10
2255	S-12

▶ POTE DE GANCHO ZINCADO COM BUCHA SEM ANEL



Formato do Gancho



CODIGO	MEDIDA	QUANTIDADE
2264	S-6	200 PEÇAS
2265	S-8	100 PEÇAS
2266	S-10	100 PEÇAS
2267	S-12	100 PEÇAS

▶ POTE DE GANCHO ZINCADO COM BUCHA COM ANEL

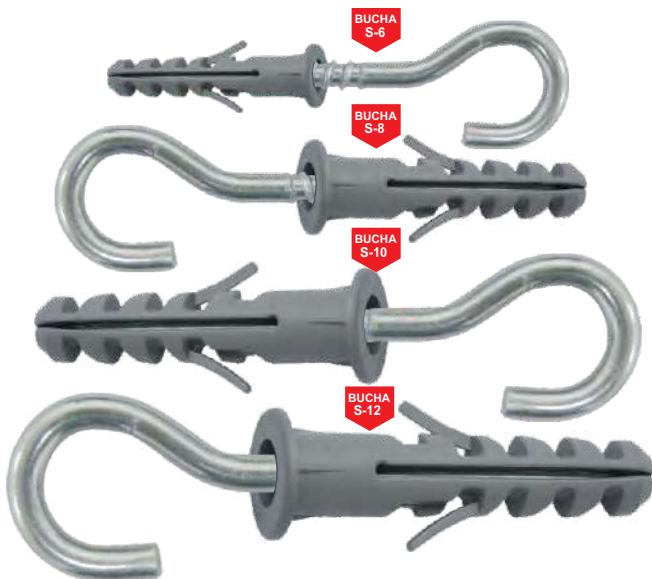

Formato do Gancho



CODIGO	MEDIDA	QUANTIDADE
2285	S-6	200 PEÇAS
2286	S-8	100 PEÇAS
2287	S-10	100 PEÇAS
2288	S-12	100 PEÇAS

► PITÃO ZINCADO



Formato do Gancho



- Indicado para a fixação em madeira (sem bucha para fixação), alvenaria e concreto (utilizar bucha para fixação), como suporte para os mais variados objetos.
- Possui acabamento zincado que aumenta a proteção contra oxidação/corrosão
- Material: aço carbono
- Acabamento: zincado

CODIGO	MEDIDA
2256	S-6
2257	S-8
2258	S-10
2259	S-12

► POTE DE PITÃO ZINCADO COM BUCHA SEM ANEL



Formato do Gancho



CODIGO	MEDIDA	QUANTIDADE
2268	S-6	200 PEÇAS
2269	S-8	100 PEÇAS
2270	S-10	100 PEÇAS
2271	S-12	100 PEÇAS

► POTE DE PITÃO ZINCADO COM BUCHA COM ANEL



Formato do Gancho



CODIGO	MEDIDA	QUANTIDADE
2289	S-6	200 PEÇAS
2290	S-8	100 PEÇAS
2291	S-10	100 PEÇAS
2292	S-12	100 PEÇAS

► ESCÁPULA ZINCADO

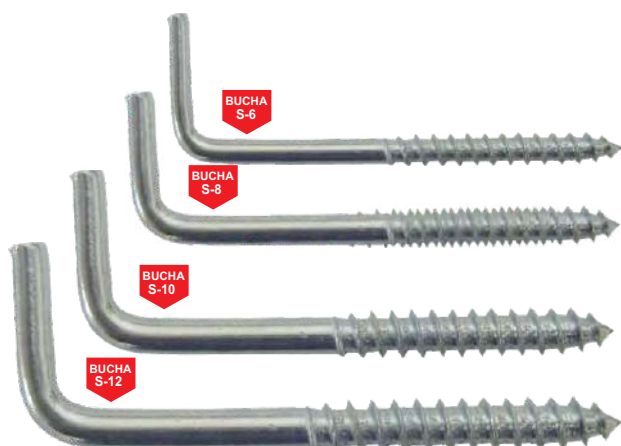

Formato do Gancho



- Indicado para a fixação em madeira (sem bucha para fixação), alvenaria e concreto (utilizar bucha para fixação), como suporte para os mais variados objetos.
- Possui acabamento zincado que aumenta a proteção contra oxidação/corrosão
- Material: aço carbono
- Acabamento: zincado

CODIGO	MEDIDA
2260	S-6
2261	S-8
2262	S-10
2263	S-12

► POTE DE ESCÁPULA ZINCADO COM BUCHA SEM ANEL



Formato do Gancho

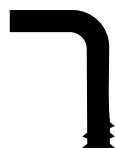

CODIGO	MEDIDA	QUANTIDADE
2272	S-6	200 PEÇAS
2273	S-8	100 PEÇAS
2274	S-10	100 PEÇAS
2275	S-12	100 PEÇAS

► POTE DE ESCÁPULA ZINCADO COM BUCHA COM ANEL

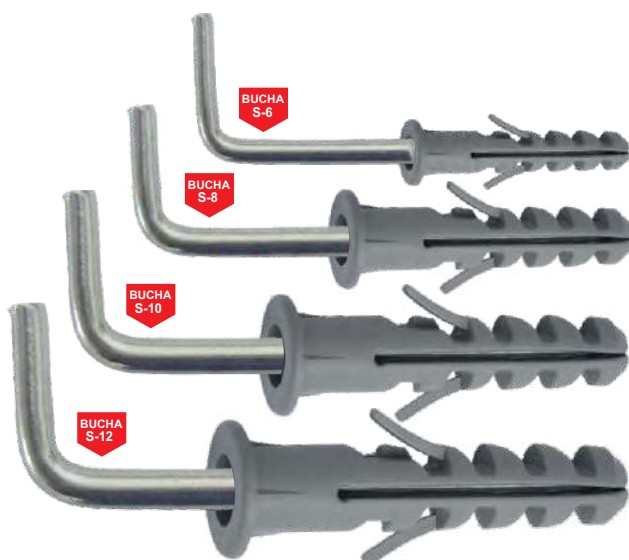

Formato do Gancho



CODIGO	MEDIDA	QUANTIDADE
2293	S-6	200 PEÇAS
2294	S-8	100 PEÇAS
2295	S-10	100 PEÇAS
2296	S-12	100 PEÇAS

► POTE DE PARAFUSO CABEÇA PANELA COM BUCHA SEM ANEL



Cabeça
Panela

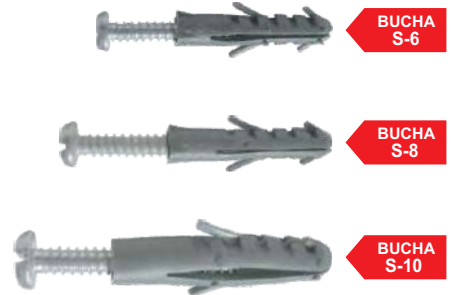

CODIGO	BUCHA	BITOLA PARAFUSO	QUANTIDADE
2276	S-6	4,2X32MM	500 PEÇAS
2277	S-8	5,5X38MM	400 PEÇAS
2278	S-10	6,3X50MM	200 PEÇAS

► POTE DE PARAFUSO CABEÇA PANELA COM BUCHA COM ANEL



Cabeça
Panela

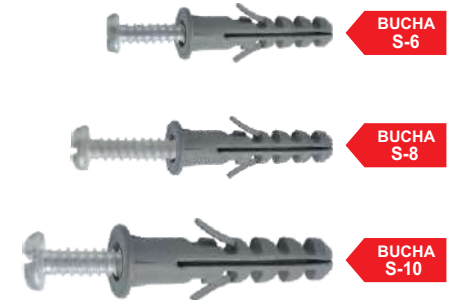

CODIGO	BUCHA	BITOLA PARAFUSO	QUANTIDADE
2297	S-6	4,2X32MM	500 PEÇAS
2298	S-8	5,5X38MM	400 PEÇAS
2299	S-10	6,3X50MM	200 PEÇAS

► POTE DE PARAFUSO CABEÇA CHATA COM BUCHA SEM ANEL



Cabeça
Chata

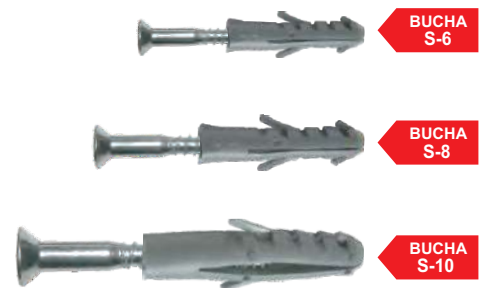

CODIGO	BUCHA	BITOLA PARAFUSO	QUANTIDADE
2279	S-6	4,0X30MM	500 PEÇAS
2280	S-8	5,0X40MM	500 PEÇAS
2281	S-10	6,0X50MM	200 PEÇAS

► POTE DE PARAFUSO CABEÇA CHATA COM BUCHA COM ANEL



Cabeça Chata



BUCHA S-6



BUCHA S-8



BUCHA S-10

CODIGO	BUCHA	BITOLA PARAFUSO	QUANTIDADE
2300	S-6	4,0X30MM	500 PEÇAS
2301	S-8	5,0X40MM	500 PEÇAS
2302	S-10	6,0X50MM	200 PEÇAS

► POTE DE PARAFUSO SEXTAVADO ROSCA SOBERBA COM BUCHA SEM ANEL



Cabeça Sextavada



BUCHA S-8



BUCHA S-10



BUCHA S-12

CODIGO	BUCHA	BITOLA PARAFUSO	QUANTIDADE
2282	S-8	3/16"X45MM	100 PEÇAS
2283	S-10	1/4"X55MM	100 PEÇAS
2284	S-12	5/16"X65MM	100 PEÇAS

► POTE DE PARAFUSO SEXTAVADO ROSCA SOBERBA COM BUCHA COM ANEL



Cabeça Sextavada



BUCHA S-8



BUCHA S-10



BUCHA S-12

CODIGO	BUCHA	BITOLA PARAFUSO	QUANTIDADE
2303	S-8	3/16"X45MM	100 PEÇAS
2304	S-10	1/4"X55MM	100 PEÇAS
2305	S-12	5/16"X65MM	100 PEÇAS

► KIT BUCHAS DE PAREDE
Codigo: 10631

**9100
PEÇAS**

CODIGO	COMPOSIÇÃO	QTD.
2215	BUCHA FIXACAO S/ANEL CINZA S-6	1000
2217	BUCHA FIXACAO S/ANEL CINZA S-8	1000
2218	BUCHA FIXACAO S/ANEL CINZA S-10	500
2219	BUCHA FIXACAO S/ANEL CINZA S-12	250
2221	BUCHA FIXACAO C/ANEL CINZA S-6	1000
2222	BUCHA FIXACAO C/ANEL CINZA S-8	1000
2223	BUCHA FIXACAO C/ANEL CINZA S-10	500
2224	BUCHA FIXACAO C/ANEL CINZA S-12	250
2252	GANCHO ZINCADO S-6	100
2253	GANCHO ZINCADO S-8	100
2254	GANCHO ZINCADO S-10	100
2255	GANCHO ZINCADO S-12	100
2256	PITAO ZINCADO S-6	100
2257	PITAO ZINCADO S-8	100
2258	PITAO ZINCADO S-10	100
2259	PITAO ZINCADO S-12	100
2260	ESCAPULA ZINCADA S-6	100
2261	ESCAPULA ZINCADA S-8	100
2262	ESCAPULA ZINCADA S-10	100
2263	ESCAPULA ZINCADA S-12	100
1925	PARAFUSO CABEÇA PANELA 4,2X32MM	500
1943	PARAFUSO CABEÇA PANELA 5,5X38MM	200
1954	PARAFUSO CABEÇA PANELA 6,3X50MM	200
1808	PARAFUSO CABEÇA CHATA 4,0X30MM	500
1825	PARAFUSO CABEÇA CHATA 5,0X40MM	500
1836	PARAFUSO CABEÇA CHATA 6,0X50MM	200
1969	PARAFUSO CABEÇA SEXTAVADA 3/16"X45MM	100
1981	PARAFUSO CABEÇA SEXTAVADA 1/4"X55MM	100
1995	PARAFUSO CABEÇA SEXTAVADA 5/16"X65MM	100
10605	ESTANTE COMPLETA COM 30 GAVETAS Nº 3 AZUL	1



BOSCH

3484 MEDIDA: 17,5X8X5mm
 ESMERILHADEIRA
 OEM. f000611029
 MOD. 1338.1 / 1347.1 / 3252.2 /
 3255 / 3261 / 3278 /
 POLITRIZ MOD. 1374 /
 RETIFICA
 MOD. 1210.0 / 1211.0 / 1215.0 /
 SERRA TICO-TICO
 MOD. 1503.1 / 1506.1 / 1530.0 / 1
 / 1581.0 / 7 / 1587.1 / 2

3469 MEDIDA: 21,5X10X6,3mm
 FURADEIRA
 MOD. 1119.1 / 1121.0 / 1174.1.2 /
 POLITRIZ
 MOD. 1328.0 / 13250.0.1 /
 LIXADEIRA
 MOD. 3253.0.1 /
 MARTELO
 MOD. 11206.0 / 6 /

3477 MEDIDA: 17X6,3X6,3mm
 FURADEIRA
 MOD. 1115 / 3110 / 3147
 LIXADEIRA
 MOD. 1286 / 1288
 SERRA TICO-TICO
 MOD. 3230

3476 MEDIDA: 16X6,3X6,3mm
 ESMERILHADEIRA
 MOD. 1327 /
 RETIFICA
 MOD. 1205 /
 TESOURA
 MOD. 1504 / 1528 / 3287 / 3288

3520 MEDIDA: 22X12,3X6,2mm
 SERRA MARMORE
 MOD. 1551.1 /
 POLITRIZ
 MOD. 1359.0 / 1366.1 /
 LIXADEIRA
 MOD. 1323.0 /
 FURADEIRA
 MOD. 1121 /

3474 MEDIDA: 16X8X6,3mm
 FURADEIRA
 OEM. 2604320902
 MOD. 0575.0/0576.0/1106.0/1107.0/
 1108.0/1123.0.7/1124.0.7/
 1150.0/1151.0

3463 MEDIDA: 16X7,9X4,9mm
 FURADEIRA HOBBY
 OEM. 1607014117
 MOD. 1106.0.1/1125.0/1129.0/
 1171.0.7/1182.0/1184.0.1/
 1270.1.2/1292.0.7/1293.0.7

3470 MEDIDA: 16X8X5mm
 FURADEIRA SUPER HOBBY
 OEM. 9618086870
 MOD. 1135.0.5/1187.0/3114.0.5/
 3219.33240.2.5/3242.2/ 3246.0/
 .2/.7/9 617 081.359/9 617 081.360

3482 MEDIDA: 19X12X6,2mm
 FURADEIRA
 MOD. 1101 / 1103 / 1201
 MARTELO
 MOD. 11203 / 1121.1 / 1214.0 / 1323.0 /

10825 MEDIDA: 15,4X8X5mm
 FURADEIRA IMPACTO
 OEM. 2609160125
 MOD. GSB 16 RE

10822 MEDIDA: 3,5X8X5mm
 FURADEIRA
 OEM. 1617000525
 MOD. GBM16-2/GBH 2-24/2-26/2-
 28/3-28 GSB20-2

3554 MEDIDA: 19X6,2X6,2mm
 FURADEIRA
 MOD. GSB13/16

3467 MEDIDA: 22X15,9X6,2mm
 ESMERILHADEIRA
 MOD. 1326.2/3257.1/1321.4/51332.
 4/51321.0/1.4/1323.1.2/4/
 OEM.9 617 081 435/9 617 081 436

3535 MEDIDA: 13X12,4X6,2mm
 ESMERILHADEIRA
 OEM. GWS 7-100
 MOD. GWS 7-100

10831
 ESMERILHADEIRA
 OEM. 1607000D3N
 MOD. GWS 850

10830
 ESMERILHADEIRA
 OEM. 1619P11715
 MOD. GWS 9-125

3519 MEDIDA: 17X9,9X4,7mm
 ESMERILHADEIRA
 MOD. 1701 /
 ESMERILHADEIRA
 MOD. EW7 115

3561 MEDIDA: 23X13,9X5,9mm
 ESMERILHADEIRA
 MOD. 1306 / 1307

3528 MEDIDA: 17,4X10X4,9mm
 ESMERILHADEIRA ANGULAR
 OEM. F000611019
 MOD. 1800

BOSCH



10835
ESMERILHADEIRA ANGULAR
OEM. 1607014144
MOD. 1375.0

BOSCH



10829
ESMERILHADEIRA ANGULAR
MOD. GWS 850

BOSCH



10826 MEDIDA: 17,6X10X6mm
ESMERILHADEIRA ANGULAR
OEM. 1607000V37
MOD. GWS 13-125 CI/GWS 17-125

BOSCH



3468 MEDIDA: 22X15,9X6,2mm
LIXADEIRA MOD. ANTIGO
OEM. F000611090
MOD. 1359.0/1363.0/1365.0/
1367.7/1368.7/1751.0/1757.0/
1854.8/3218.0/1351

BOSCH



3475 MEDIDA: 16X6,2X5,5mm
LIXADEIRA
MOD. MODELO ANTIGO

BOSCH



10836
POLITRIZ ANGULAR
OEM. F000611078
MOD. 9071

BOSCH



3494 MEDIDA: 17,5X8X5mm
POLITRIZ
OEM. F000611029
MOD. 537 / 538 /

DRWALT



10828 MEDIDA: 13X10,4X7mm
MARTELO
OEM. 939539-01
MOD. N418050 - N418039 -
D25133 -D25134

BOSCH



10843 MEDIDA: 22,6X11,9X5,9mm
MARTELO
OEM. 1617014144
MOD. 11235.7

BOSCH

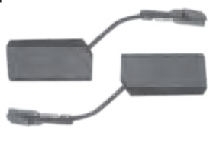

3481 MEDIDA: 19X8X5mm
MARTELO
OEM. F000611028
MOD. 11234.0 / 11226.0 / 11228.6/
GBH 2-24

BOSCH



3521 MEDIDA: 26X15,8X6,1mm
MARTELO
OEM. 1617014143
MOD. 11311 / 11316 / 11223 /
11235 / 11245 / 11345

BOSCH



3543 MEDIDA: 3,3X7,9X4,8mm
MARTELO PERFURADOR
OEM. 1614321079
MOD. 11332-GBH 4-32

BOSCH



3544 MEDIDA: 23X10X5mm
MARTELO ROMPEDOR
MOD. GBH 3-28 DRE

BOSCH



3541 MEDIDA: 17,5X10X5mm
MARTELO PERFURADOR
MOD. 11222 / 11236

BOSCH



3496 MEDIDA: 17X9,8X6,2mm
SERRA MARMORE
MOD. 1551.0

BOSCH



10816 MEDIDA: 15,2X12,3X6,2mm
SERRA MARMORE
MOD. 1551.1/4 /H 43

BOSCH



3512 MEDIDA: 15,2X12,3X6,2mm
SERRA MARMORE
OEM. F000611036
MOD. 1548.1

BOSCH



3511 MEDIDA: 12X6,2X6,2mm
SERRA CIRCULAR
MOD. 3328 / PK.540

BOSCH



3548 MEDIDA: 20X11X7mm
SERRA CIRCULAR
OEM. F000611020
MOD. 5300

BOSCH



10827 MEDIDA: 23X12,4X6,2mm
SERRA CIRCULAR
OEM. 1619P06346
MOD. GKS 67/GKS 190

BOSCH

10833

SERRA CIRCULAR
OEM. 1604321179
MOD. GKS 150

BOSCH
DREMEL

3555 MEDIDA: 19X6,2X6,2mm

SERRA CIRCULAR
MOD. 5600
SERRA CIRCULAR
OEM. P/F000611020
MOD. 7 1/4 5600

BOSCH

10845 MEDIDA: 13,7X7,9X4,9mm

SERRA TICO TICO
MOD. GST65E

DEWALT

3490 MEDIDA: 17,3x10,5x7,1mm

LIXADEIRA POLITRIZ
MOD. 849 /
SERRA CIRCULAR
MOD. 352 / 359 /
SABRE
MOD. 304 K

DEWALT

3491 MEDIDA: 13,5x7,9x6,2mm

ESMERILHADEIRA
MOD. 448 / 818
ESMERILHADEIRA
MOD. 5411
FURADEIRA
MOD. 1121 / 1521 / 1622 /
2224 / 2621 / 2615

DEWALT

3497 MEDIDA: 13,8X7X6mm

ESMERILHADEIRA
MOD. 402 /
SERRA TICO-TICO
MOD. 313 / 318 / 3153 / 3157

DEWALT

3492 MEDIDA: 13,8x7x6mm

FURADEIRA
MOD. 107 / 503 / 508

DEWALT

3550 MEDIDA: 26,5X15,9X6,3mm

FURADEIRA
OEM. 186862
MOD. DW502

DEWALT

3509 MEDIDA: 13,7X6,9X5,8mm

FURADEIRA 3/8
MOD. 105 / 501 / 507 /
FURADEIRA
MOD. 1161

ARNO

3505 MEDIDA: 16X6,2X4,8mm

FURADEIRA
MOD. FIC

DEWALT

10823 MEDIDA: 13X10,4X7mm

ESMERILHADEIRA
OEM. 939539-01
MOD. DWE 4010 B2B2/939539-01

DEWALT

10834

ESMERILHADEIRA
MOD. DWE4314 N421362/
N257540/N439879

DEWALT

3531 MEDIDA: 13,5X10X6,4mm

ESMERILHADEIRA
MOD. 28111/28136/28476

DEWALT

3540 MEDIDA: 20,2X9,7X6,1mm

ESMERILHADEIRA
MOD. 830 5"

DEWALT

10820 MEDIDA: 16,5X8X6,3mm

ESMERILHADEIRA
OEM. n097698/n439879
MOD. dwe 4010/20 dwe 4212/4314

DEWALT

3498 MEDIDA: 13,8X7X6mm

LIXADEIRA ORBITAL
MOD. 412 / 421 / 4011

DEWALT

10817 MEDIDA: 13X10,4X7mm

POLITRIZ
MOD. DW849X

DEWALT

3503 MEDIDA: 18x8x5,7mm

MARTELO
MOD. 523 / 557 / 563 / 566 / 5054



3539 MEDIDA: 18X8X5,7mm
MARTELO
 MOD. 523 / 557 / 5054



3495 MEDIDA: 22X9,8X5,9mm
MARTELO
 OEM. 1617014138
 MOD. 541 /543 /545



3536 MEDIDA: 26,5X15,9X6,3mm
MARTELETE
 OEM.487266
 MOD. D25900



3501 MEDIDA: 19X10,9X6,9mm
SERRA MARMORE
 MOD. 301 / 3011

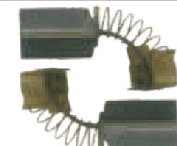

3559 MEDIDA: 18X9,8X6mm
SERRA MARMORE
 MOD. 861 B

3493 MEDIDA: 13,8X8,9X5,9mm
SERRA MARMORE
 OEM. CB419
 MOD. 4100 NB / 4100 H /
SERRA CIRCULAR
 MOD. 4200 H / 4200 N / 5800 H //
LIXADEIRA
 MOD. 9207 / 9218 /
LIXADEIRA DE CINTA
 MOD. 9924 /6906 / 8035 NB /
 8700 N / 9045 B / 9045 N

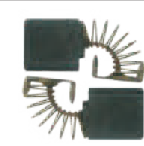

3485 MEDIDA: 20X17,9X6,9mm
ESMERILHADEIRA
 OEM. CB204
 MOD. 9027 / 9029 / 9047 / 9049 /
MARTELO
 MOD. HM 1302 / HM 1303 B /
 HM 1500 B / HM 1800
SERRA RAPIDA
 MOD. 2414



3516 MEDIDA: 12,7X8X5mm
FURADEIRA
 OEM. CB51
 MOD. 8419 B / 6016 BR /
PLAINA
 MOD. 1900 B /
SERRA TICO-TICO
 MOD. 4300 BA / 4300 BV /
LIXADEIRA DE CINTA
 MOD. 9031 /

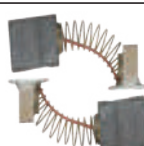

3517 MEDIDA: 18,3X13,4X6,4mm
LIXADEIRA
 OEM. CB153
 MOD. 9209 /
ESMERILHADEIRA
 MOD. 9607 / 9609 / 9105 /
SERRA CIRCULAR
 MOD. 5900 / 2414 /
SERRA MARMORE
 MOD. 4107 / 3612/8600 / 8600 N /

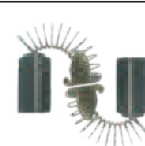

3473 MEDIDA: 16X9,9X5,9mm
SERRA MARMORE
 OEM. CB101
 MOD. 4100 NB / 4100 H /
SERRA CIRCULAR
 MOD.4200 H / 4200 N / 5800 H /
LIXADEIRA
 MOD. 9207 / 9218 /
LIXADEIRA DE CINTA
 MOD. 9924 /6906 / 8035 NB /
 8700 N / 9045 B / 9045 N

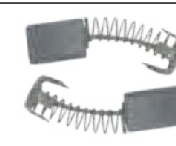

3478 MEDIDA: 11,5X7,9X5mm
FURADEIRA
 OEM. CB64
 MOD. HP 1010 / HP 1320 S /
 DP 3730 / DP 3750 / 6510 BVR /
LIXADEIRA ORBITAL
 MOD. BO 4510 / BO 4540 / 5010 / 9035 /
FURADEIRA
 MOD. 906 / 8010 B / 8510 H / 8510
 PBL / 8802 BV / 9035 / 9504 BH

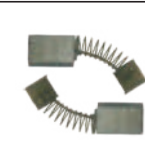

3500 MEDIDA: 12X8X5mm
FURADEIRA
 OEM. CB70
 MOD. 6404 / 6405 /
SERRA TICO-TICO
 MOD. 4320 / 4321 /6501 /9514 B /
 9514 BH /



3547 MEDIDA: 13X8,8X5,9mm
ESMERILHADEIRA
 OEM.CB 459
 MOD. GA 4530



10844 MEDIDA: 13X8,6X6,1mm
ESMERILHADEIRA
 MOD. GA 4030

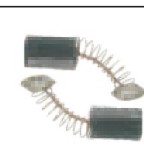

3499 MEDIDA: 12,5X7,9X5mm
ESMERILHADEIRA
 OEM.CB65
 MOD. 906 H /6905 B /6914 /9500 N
 /9500 NH /9803 /DA 300 R /JS 1660 /



3525 MEDIDA: 17X10,8X5mm
ESMERILHADEIRA
 OEM. CB 325
 MOD. HM1203 C / 9554/9557
MARTELETE
 MOD. HR2450/2470

Makita

3508 MEDIDA: 13,8X8,9X6mm
ESMERILHADEIRA
 OEM. CB408
 MOD. 9500 N / 9524 NB

Makita

3534 MEDIDA: 20,4X13,2X6,1mm
MAKITA
 OEM. CB155
 MOD. HM1202C/1301

Makita

3545 MEDIDA: 15X10,9X6,4mm
MAKITA
 OEM. CB350
 MOD. CB350

Makita

3560 MEDIDA: 19,2X10,9X5mm
MAKITA
 OEM. CB303 NEW
 MOD. MVCC400/MT410

Makita

10848 MEDIDA: 25X12,1X6mm
MAKITA
 OEM. CB 323
 MOD. HM 0860

Makita

10847 MEDIDA: 12,2X7X6,7mm
MAKITA
 OEM. CB430
 MOD. 6319D/6339D/6349D/8414D

Makita

3504 MEDIDA: 19,2X10,9X5mm
SERRA MARMORE
 OEM. CB303
 MOD. 4100 NHK /
 LIXADEIRA POLITRIZ
 MOD. 9227 C

Makita

3518 MEDIDA: 16X9,9X5,9mm
SERRA MARMORE
 OEM. CB100
 MOD. 4100H/4200H/5800

Makita

3533 MEDIDA: 19X10,8X7cm
SERRA MARMORE
 OEM. cb253
 MOD. pc5000c, pc5001c, jr3020;

Makita

3556 MEDIDA: 16,9X10X6mm
MARTELO ROMPEDOR
 OEM. CB 113
 MOD. HP2000 /Hm0860
MAKITA
 MOD. HK0500

Makita

3510 MEDIDA: 19,1X9,8X5,9mm
MARTELO MAKITA
 OEM. cb105
 MOD. HK 1800 /HK 1800-L /
 HK 1810 /HM 0810 /HM 0811 /
 HM 0821 /HR 1800 /HR 1820 /
 HR 2210 /

Makita

10846 MEDIDA: 27,5X13,3X6,2mm
MARTELO
 MOD. HM1203 C
 OEM. CB175

Makita

10842 MEDIDA: 18X12,3X6,1mm
MARTELO PERFURADOR

BLACK+DECKER

3479 MEDIDA: 16X6,3X6,3mm
FURADEIRA
SERRA TICO-TICO
LIXADEIRA ORBITAL
SERRA CIRCULAR
 MOD. 7204 / 7504 / 7547 /
 7010 /8594 / 85944 / 7508 /
 7104 / 7408 /7310 / RUS

BLACK+DECKER

3480 MEDIDA: 16X6,3X6,3mm
FURADEIRA
 MOD. 1033/1040 / 1380 / 2034 /
 7928 / 7930 / 7900 / 7932 / 1190

BLACK+DECKER

3522 MEDIDA: 12X8,9X6,9mm
FURADEIRA
 OEM.832998
 MOD. KR500 / KR502 / KR 510 RE /
 KR 500 / RE KR532



3502 MEDIDA: 16X6,2X6,2mm
 FURADEIRA
 OEM. 184571
 MOD. 7930/7933/7935/7950



3483 MEDIDA: 17X6mm
 FURADEIRA
 MOD. U 112 / 114 / 138



3532 MEDIDA: 18X6X6mm
 FURADEIRA
 MOD. KR505



10821 MEDIDA: 11x6,3x6,3mm
 FURADEIRA
 MOD. KR580/60/600/650/700



10819 MEDIDA: 16x6x6mm
 FURADEIRA
 MOD. TM500



3513 MEDIDA: 15,5X7,9X6,4mm
 ESMERILHADEIRA
 MOD. G730



10818 MEDIDA: 22,5x12,5x6mm
 ESMERILHADEIRA
 MOD. B 500-B2/B500-BR



10824 MEDIDA: 15X8,8X5,9mm
 ESMERILHADEIRA
 MOD. G720-B2



3558 MEDIDA: 9X8X5mm
 ESMERILHADEIRA
 MOD. KG915



3549 MEDIDA: 22X16X6mm
 ESMERILHADEIRA
 MOD. KG915



3523 MEDIDA: 12X7,8X4,9mm
 ESMERILHADEIRA
 MOD. G.720



3488 MEDIDA: 22x15,9x6,2mm
 ESMERILHADEIRA
 COTADORA DE METAIS
 MOD. 618 / 622 / 818 / 822478
 / 848 / 852 / 875



3552 MEDIDA: 14,5X10X5,9mm
 LIXADEIRA
 MOD. 1300



3472 MEDIDA: 20X12X6,2mm
 LIXADEIRA
 MOD. LEM-80



3489 MEDIDA: 22X10,5X7mm
 LIXADEIRA POLITRIZ
 SERRA MARMORE
 SABRE
 CHAVE IMPACTO
 MOD. 6138 /3011 /3103 /2674 /



3487 MEDIDA: 13,7x7x6mm
 POLITRIZ ORBITAL
 MOD. 9555



3486 MEDIDA: 13,4X9,3X6mm
 SERRA CIRCULAR
 OEM. 137865
 MOD. 7308 /7358 /7392 /3026



SKIL

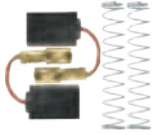

3526 MEDIDA: 16X7,9X4,8mm
FURADEIRA

SKIL



3506 MEDIDA: 20X6,8X5mm
FURADEIRA SKIL

SKIL



3527 MEDIDA: 15X8,3X6mm
ESMERILHADEIRA
MOD. 4,1/2

SKIL



10832
ESMERILHADEIRA
OEM. 2610Z00180
MOD. 9002/9004

SKIL



3507 MEDIDA: 13,6X9,3X6,3mm
SERRA CIRCULAR / SKIL
MOD. 1573 / 5150 / 550 / 5660
/5170 /1986

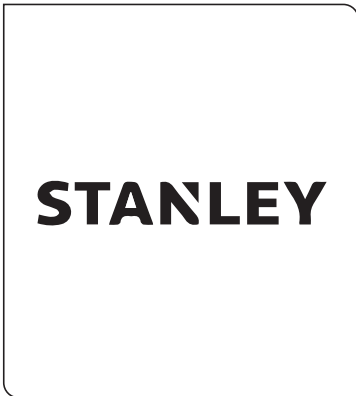

STANLEY



10851 MEDIDA: 12,6X8,1X5mm
FURADEIRA IMPACTO
MOD. 5140179-02/03 SDH600 /700

STANLEY



10849 MEDIDA: 18X8X5mm
FURADEIRA IMPACTO
MOD. STDH8013 5140166-12
KD620K

STANLEY



10854 MEDIDA: 16X8X5mm
ESMERILHADEIRA ANGULAR
MOD. 5140165-17 STGS5115

STANLEY



10855 MEDIDA: 16X10X6,3mm
ESMERILHADEIRA ANGULAR
MOD. 5140014-98 STG1011

STANLEY



10850
POLITRIZ
MOD. STGP612K / WP600K /

STANLEY



10858
POLITRIZ
MOD. 5140090-93 STGP1318

STANLEY



10856 MEDIDA: 16,6X12,8X6,8mm
SERRA CIRCULAR
MOD. 90587393 STSC1718

STANLEY



10857 MEDIDA: 17X8X6mm
MARTELETE
MOD. N465518 SHR263

STANLEY



10852 MEDIDA: 16X10X6mm
MARTELETE
MOD. 5140193-15 SHM51604

STANLEY



10853 MEDIDA: 16X8X5mm
PLAINA
MOD. 5140101-50 STPP7502

Ferrari



3538 MEDIDA: 11X7,8X4,8mm
FURADEIRA
MOD. FIR 13-A

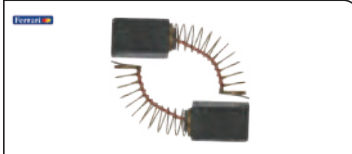

3524 MEDIDA: 19X11,7X4,6mm
SERRA MARMORE
MOD. SMA 950 PIV



3537 MEDIDA: 20X10,9X6,9mm
SERRA MARMORE

DWT



3546 MEDIDA: 11,2X10X5,9mm
ESMERILHADEIRA
MOD. 4 1/2 DWT DIV



3530 MEDIDA: 12,5X10,1X5,8mm
ESMERILHADEIRA
MOD. DWT 4/2



3557 MEDIDA: 17X15,9X6,2mm
ESMERILHADEIRA
MOD. 8-180T



3542 MEDIDA: 14X11,2X6,5mm
SERRA MARMORE
MOD. DWT MS 110



3551 MEDIDA: 14X11,2X6,5mm
SERRA MARMORE
MOD. DWT MS 110

BAMBOZZI
TRADICAO NA INGENHARIA

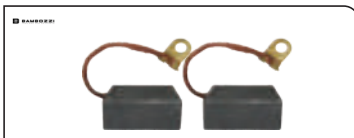

3514 MEDIDA: 35X17X13mm
MAQUINA SOLDA BAMBOZZI
COD. RE59

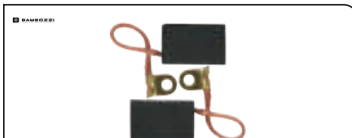

3515 MEDIDA: 20X15X6mm
GERADOR BAMBOZZI
COD. RE54

metabo

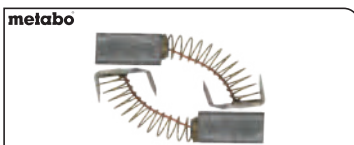

3529 MEDIDA: 19X11X6,9mm
SERRA MARMORE
MOD. TC-4110



3519 MEDIDA: 17X9,9X4,7mm
ESMERILHADEIRA
MOD. 1701 /
ESMERILHADEIRA
MOD. EW7 115

Thabor

Thabor



3464 MEDIDA: 22X11X6,3mm

LIXADEIRA PEQUENA
MOD. POL.LP.9/RET.14
POLITRIZ
MOD. LP.9
ESMERILHADEIRA
MOD. 13 / 14
CORTA PAREDE
MOD. THT 500

Thabor



3465 MEDIDA: 23X15,9X6,3mm

ESMERILHADEIRA GRANDE
MOD. LIX.LT3/6
LIXADEIRA
MOD. LT3 / Lt6
CORTA PAREDE
MOD. THT 120



3466 MEDIDA: 18,5X8X5mm

FURADEIRA
MOD. 1167 / ASZ / DSC / DS
RETIFICA
MOD. DSC/DS.648

DREMEL



3553 MEDIDA: 15X6,2X4,6mm

RETIFICA

ARNO

ARNO

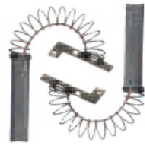

3471 MEDIDA: 28X8,8X5,8mm

TANQUINHO

ARNO



10837 MEDIDA: 32,2X9X6mm

TANQUINHO



Electrolux



10838 MEDIDA: :27,5X11,5X6,1mm

ASPIRADOR
MOD: GT 3000/TRIO



10839 MEDIDA: :34,2X11,5X6,2mm

ASPIRADOR
MOD: AH735



10840 MEDIDA: :34,2X11,5X6,2mm

ASPIRADOR
MOD: BPS-15



10841 MEDIDA: :29X10X6,1mm

ASPIRADOR
MOD: BPS-25



KOHLBACH



10859 MEDIDA: :30X10X10mm

GERADOR
COD: BPS-15



10860 MEDIDA: :30X14X10mm

GERADOR
MOD: BPS-25

► KIT ESCOVA DE CARVÃO

Codigo: 10643

- Escovas de carvão mais vendidas
- 6 unidades por modelo
- 18 modelos
- 108 peças



108 PEÇAS

 3484 MEDIDA: 17,2x30x5mm ESMERLHADERA OEM: 900611029 MOD: 1325.1 / 1325.2 / 1325.3 / 1325.4 / 1325.5 / 1325.6 / 1325.7 / 1325.8 / 1325.9 / 1325.10 / 1325.11 / 1325.12 / 1325.13 / 1325.14 / 1325.15 / 1325.16 / 1325.17 / 1325.18 / 1325.19 / 1325.20 / 1325.21 / 1325.22 / 1325.23 / 1325.24 / 1325.25 / 1325.26 / 1325.27 / 1325.28 / 1325.29 / 1325.30 / 1325.31 / 1325.32 / 1325.33 / 1325.34 / 1325.35 / 1325.36 / 1325.37 / 1325.38 / 1325.39 / 1325.40 / 1325.41 / 1325.42 / 1325.43 / 1325.44 / 1325.45 / 1325.46 / 1325.47 / 1325.48 / 1325.49 / 1325.50 / 1325.51 / 1325.52 / 1325.53 / 1325.54 / 1325.55 / 1325.56 / 1325.57 / 1325.58 / 1325.59 / 1325.60 / 1325.61 / 1325.62 / 1325.63 / 1325.64 / 1325.65 / 1325.66 / 1325.67 / 1325.68 / 1325.69 / 1325.70 / 1325.71 / 1325.72 / 1325.73 / 1325.74 / 1325.75 / 1325.76 / 1325.77 / 1325.78 / 1325.79 / 1325.80 / 1325.81 / 1325.82 / 1325.83 / 1325.84 / 1325.85 / 1325.86 / 1325.87 / 1325.88 / 1325.89 / 1325.90 / 1325.91 / 1325.92 / 1325.93 / 1325.94 / 1325.95 / 1325.96 / 1325.97 / 1325.98 / 1325.99 / 1325.100	 3463 MEDIDA: 14,7x34,5x5mm FURADERA HOBBY OEM: 150014117 MOD: 1171.0 / 1171.1 / 1171.2 / 1171.3 / 1171.4 / 1171.5 / 1171.6 / 1171.7 / 1171.8 / 1171.9 / 1171.10 / 1171.11 / 1171.12 / 1171.13 / 1171.14 / 1171.15 / 1171.16 / 1171.17 / 1171.18 / 1171.19 / 1171.20 / 1171.21 / 1171.22 / 1171.23 / 1171.24 / 1171.25 / 1171.26 / 1171.27 / 1171.28 / 1171.29 / 1171.30 / 1171.31 / 1171.32 / 1171.33 / 1171.34 / 1171.35 / 1171.36 / 1171.37 / 1171.38 / 1171.39 / 1171.40 / 1171.41 / 1171.42 / 1171.43 / 1171.44 / 1171.45 / 1171.46 / 1171.47 / 1171.48 / 1171.49 / 1171.50 / 1171.51 / 1171.52 / 1171.53 / 1171.54 / 1171.55 / 1171.56 / 1171.57 / 1171.58 / 1171.59 / 1171.60 / 1171.61 / 1171.62 / 1171.63 / 1171.64 / 1171.65 / 1171.66 / 1171.67 / 1171.68 / 1171.69 / 1171.70 / 1171.71 / 1171.72 / 1171.73 / 1171.74 / 1171.75 / 1171.76 / 1171.77 / 1171.78 / 1171.79 / 1171.80 / 1171.81 / 1171.82 / 1171.83 / 1171.84 / 1171.85 / 1171.86 / 1171.87 / 1171.88 / 1171.89 / 1171.90 / 1171.91 / 1171.92 / 1171.93 / 1171.94 / 1171.95 / 1171.96 / 1171.97 / 1171.98 / 1171.99 / 1171.100	 3470 MEDIDA: 14,8x30x5mm FURADERA SUPER HOBBY OEM: 961809670 MOD: 1132.0 / 1132.1 / 1132.2 / 1132.3 / 1132.4 / 1132.5 / 1132.6 / 1132.7 / 1132.8 / 1132.9 / 1132.10 / 1132.11 / 1132.12 / 1132.13 / 1132.14 / 1132.15 / 1132.16 / 1132.17 / 1132.18 / 1132.19 / 1132.20 / 1132.21 / 1132.22 / 1132.23 / 1132.24 / 1132.25 / 1132.26 / 1132.27 / 1132.28 / 1132.29 / 1132.30 / 1132.31 / 1132.32 / 1132.33 / 1132.34 / 1132.35 / 1132.36 / 1132.37 / 1132.38 / 1132.39 / 1132.40 / 1132.41 / 1132.42 / 1132.43 / 1132.44 / 1132.45 / 1132.46 / 1132.47 / 1132.48 / 1132.49 / 1132.50 / 1132.51 / 1132.52 / 1132.53 / 1132.54 / 1132.55 / 1132.56 / 1132.57 / 1132.58 / 1132.59 / 1132.60 / 1132.61 / 1132.62 / 1132.63 / 1132.64 / 1132.65 / 1132.66 / 1132.67 / 1132.68 / 1132.69 / 1132.70 / 1132.71 / 1132.72 / 1132.73 / 1132.74 / 1132.75 / 1132.76 / 1132.77 / 1132.78 / 1132.79 / 1132.80 / 1132.81 / 1132.82 / 1132.83 / 1132.84 / 1132.85 / 1132.86 / 1132.87 / 1132.88 / 1132.89 / 1132.90 / 1132.91 / 1132.92 / 1132.93 / 1132.94 / 1132.95 / 1132.96 / 1132.97 / 1132.98 / 1132.99 / 1132.100	 3535 MEDIDA: 13,1x2,4x22mm ESMERLHADERA OEM: 605 7-100 MOD: 085 7-100	 10831 MEDIDA: 13,1x2,4x22mm ESMERLHADERA OEM: 1607000394 MOD: 085 950	 3519 MEDIDA: 17,5x34,7mm ESMERLHADERA MOD: 1101 ESMERLHADERA MOD: 087 115
 3496 MEDIDA: 17,5x36x5mm SERRA MARMORE MOD: 1551.0	 3493 MEDIDA: 13,8x34,5x5mm SERRA MARMORE OEM: 02419 MOD: 4100 N / 4100 H / SERRA CIRCULAR MOD: 4200 N / 4200 H / 5800 N // LIXADERA MOD: 321 / 321.8 LIXADERA DE CINTA MOD: 9045 B / 9045 NB / 8700 N / 9045 B / 9045 N	 3485 MEDIDA: 20x17,5x6x5mm ESMERLHADERA OEM: 02024 MOD: 9027 / 9029 / 9047 / 9049 / MARTELO MOD: 9M 1302 / 9M 1303 B / 9M 1500 B / 9M 1800 SERRA RÁPIDA MOD: 2414	 3547 MEDIDA: 13M,8x5,5x5mm ESMERLHADERA OEM: 03 459 MOD: GA 4530	 3481 MEDIDA: 15,8x34,5mm MARTELO OEM: 900611028 MOD: 11234.0 / 11226.0 / 11228.6 / 901 2-24	 3491 MEDIDA: 13,5x7,5x4,5mm ESMERLHADERA MOD: 448 219 ESMERLHADERA MOD: 411 FURADERA MOD: 1121 / 1521 / 1622 / 2224 / 2621 / 2615
 3508 MEDIDA: 13,3x4,5x6mm ESMERLHADERA OEM: 03408 MOD: 9500 N / 9524 NB	 3560 MEDIDA: 19,2x10,5x6mm MARTELO OEM: 03303 NEW MOD: MVCC400MT410	 3504 MEDIDA: 19,2x10,5x6mm SERRA MARMORE OEM: 03304 MOD: 4100 NB // LIXADERA MOD: 9327 C	 3513 MEDIDA: 15,5x7,5x6,4mm ESMERLHADERA MOD: 6730	 10824 MEDIDA: 15,8x,8x5,5mm ESMERLHADERA MOD: 6720-82	 3526 MEDIDA: 18,7x34,4x6mm FURADERA MOD: 6720-82

► KIT ESCOVA DE CARVÃO PREMIUM

Codigo: 10644

- Escovas de carvão mais vendidas
- 6 unidades por modelo
- 30 modelos
- 180 peças



180 PEÇAS

 3484 MEDIDA: 17,2x30x5mm ESMERLHADERA OEM: 900611029 MOD: 1325.1 / 1325.2 / 1325.3 / 1325.4 / 1325.5 / 1325.6 / 1325.7 / 1325.8 / 1325.9 / 1325.10 / 1325.11 / 1325.12 / 1325.13 / 1325.14 / 1325.15 / 1325.16 / 1325.17 / 1325.18 / 1325.19 / 1325.20 / 1325.21 / 1325.22 / 1325.23 / 1325.24 / 1325.25 / 1325.26 / 1325.27 / 1325.28 / 1325.29 / 1325.30 / 1325.31 / 1325.32 / 1325.33 / 1325.34 / 1325.35 / 1325.36 / 1325.37 / 1325.38 / 1325.39 / 1325.40 / 1325.41 / 1325.42 / 1325.43 / 1325.44 / 1325.45 / 1325.46 / 1325.47 / 1325.48 / 1325.49 / 1325.50 / 1325.51 / 1325.52 / 1325.53 / 1325.54 / 1325.55 / 1325.56 / 1325.57 / 1325.58 / 1325.59 / 1325.60 / 1325.61 / 1325.62 / 1325.63 / 1325.64 / 1325.65 / 1325.66 / 1325.67 / 1325.68 / 1325.69 / 1325.70 / 1325.71 / 1325.72 / 1325.73 / 1325.74 / 1325.75 / 1325.76 / 1325.77 / 1325.78 / 1325.79 / 1325.80 / 1325.81 / 1325.82 / 1325.83 / 1325.84 / 1325.85 / 1325.86 / 1325.87 / 1325.88 / 1325.89 / 1325.90 / 1325.91 / 1325.92 / 1325.93 / 1325.94 / 1325.95 / 1325.96 / 1325.97 / 1325.98 / 1325.99 / 1325.100	 3463 MEDIDA: 14,7x34,5x5mm FURADERA HOBBY OEM: 150014117 MOD: 1171.0 / 1171.1 / 1171.2 / 1171.3 / 1171.4 / 1171.5 / 1171.6 / 1171.7 / 1171.8 / 1171.9 / 1171.10 / 1171.11 / 1171.12 / 1171.13 / 1171.14 / 1171.15 / 1171.16 / 1171.17 / 1171.18 / 1171.19 / 1171.20 / 1171.21 / 1171.22 / 1171.23 / 1171.24 / 1171.25 / 1171.26 / 1171.27 / 1171.28 / 1171.29 / 1171.30 / 1171.31 / 1171.32 / 1171.33 / 1171.34 / 1171.35 / 1171.36 / 1171.37 / 1171.38 / 1171.39 / 1171.40 / 1171.41 / 1171.42 / 1171.43 / 1171.44 / 1171.45 / 1171.46 / 1171.47 / 1171.48 / 1171.49 / 1171.50 / 1171.51 / 1171.52 / 1171.53 / 1171.54 / 1171.55 / 1171.56 / 1171.57 / 1171.58 / 1171.59 / 1171.60 / 1171.61 / 1171.62 / 1171.63 / 1171.64 / 1171.65 / 1171.66 / 1171.67 / 1171.68 / 1171.69 / 1171.70 / 1171.71 / 1171.72 / 1171.73 / 1171.74 / 1171.75 / 1171.76 / 1171.77 / 1171.78 / 1171.79 / 1171.80 / 1171.81 / 1171.82 / 1171.83 / 1171.84 / 1171.85 / 1171.86 / 1171.87 / 1171.88 / 1171.89 / 1171.90 / 1171.91 / 1171.92 / 1171.93 / 1171.94 / 1171.95 / 1171.96 / 1171.97 / 1171.98 / 1171.99 / 1171.100	 3470 MEDIDA: 14,8x30x5mm FURADERA SUPER HOBBY OEM: 961809670 MOD: 1132.0 / 1132.1 / 1132.2 / 1132.3 / 1132.4 / 1132.5 / 1132.6 / 1132.7 / 1132.8 / 1132.9 / 1132.10 / 1132.11 / 1132.12 / 1132.13 / 1132.14 / 1132.15 / 1132.16 / 1132.17 / 1132.18 / 1132.19 / 1132.20 / 1132.21 / 1132.22 / 1132.23 / 1132.24 / 1132.25 / 1132.26 / 1132.27 / 1132.28 / 1132.29 / 1132.30 / 1132.31 / 1132.32 / 1132.33 / 1132.34 / 1132.35 / 1132.36 / 1132.37 / 1132.38 / 1132.39 / 1132.40 / 1132.41 / 1132.42 / 1132.43 / 1132.44 / 1132.45 / 1132.46 / 1132.47 / 1132.48 / 1132.49 / 1132.50 / 1132.51 / 1132.52 / 1132.53 / 1132.54 / 1132.55 / 1132.56 / 1132.57 / 1132.58 / 1132.59 / 1132.60 / 1132.61 / 1132.62 / 1132.63 / 1132.64 / 1132.65 / 1132.66 / 1132.67 / 1132.68 / 1132.69 / 1132.70 / 1132.71 / 1132.72 / 1132.73 / 1132.74 / 1132.75 / 1132.76 / 1132.77 / 1132.78 / 1132.79 / 1132.80 / 1132.81 / 1132.82 / 1132.83 / 1132.84 / 1132.85 / 1132.86 / 1132.87 / 1132.88 / 1132.89 / 1132.90 / 1132.91 / 1132.92 / 1132.93 / 1132.94 / 1132.95 / 1132.96 / 1132.97 / 1132.98 / 1132.99 / 1132.100	 3535 MEDIDA: 13,1x2,4x22mm ESMERLHADERA OEM: 605 7-100 MOD: 085 7-100	 10831 MEDIDA: 13,1x2,4x22mm ESMERLHADERA OEM: 1607000394 MOD: 085 950	 3519 MEDIDA: 17,5x34,7mm ESMERLHADERA MOD: 1101 ESMERLHADERA MOD: 087 115
 3496 MEDIDA: 17,5x36x5mm SERRA MARMORE MOD: 1551.0	 3493 MEDIDA: 13,8x34,5x5mm SERRA MARMORE OEM: 02419 MOD: 4100 NB / 4100 H / SERRA CIRCULAR MOD: 4200 N / 4200 H / 5800 N // LIXADERA MOD: 321 / 321.8 LIXADERA DE CINTA MOD: 9045 B / 9045 NB / 8700 N / 9045 B / 9045 N	 3485 MEDIDA: 20x17,5x6x5mm ESMERLHADERA OEM: 02024 MOD: 9027 / 9029 / 9047 / 9049 / MARTELO MOD: 9M 1302 / 9M 1303 B / 9M 1500 B / 9M 1800 SERRA RÁPIDA MOD: 2414	 3547 MEDIDA: 13M,8x5,5x5mm ESMERLHADERA OEM: 03 459 MOD: GA 4530	 3481 MEDIDA: 15,8x34,5mm MARTELO OEM: 900611028 MOD: 11234.0 / 11226.0 / 11228.6 / 901 2-24	 3491 MEDIDA: 13,5x7,5x4,5mm ESMERLHADERA MOD: 448 219 ESMERLHADERA MOD: 411 FURADERA MOD: 1121 / 1521 / 1622 / 2224 / 2621 / 2615
 3508 MEDIDA: 13,3x4,5x6mm ESMERLHADERA OEM: 03408 MOD: 9500 N / 9524 NB	 3560 MEDIDA: 19,2x10,5x6mm MARTELO OEM: 03303 NEW MOD: MVCC400MT410	 3504 MEDIDA: 19,2x10,5x6mm SERRA MARMORE OEM: 03304 MOD: 4100 NB // LIXADERA MOD: 9327 C	 3513 MEDIDA: 15,5x7,5x6,4mm ESMERLHADERA MOD: 6730	 10824 MEDIDA: 15,8x,8x5,5mm ESMERLHADERA MOD: 6720-82	 3526 MEDIDA: 18,7x34,4x6mm FURADERA MOD: 6720-82
 10822 MEDIDA: 13,5x8x5mm FURADERA OEM: 161700025 MOD: 0816-2681-2-2422-262-2819-28-05820-2	 3468 MEDIDA: 23,1x3,6x5mm LIXADERA MOD. ANTIGO OEM: 900611096 MOD: 1350.0 / 1353.0 / 1365.0 / 1367.0 / 1368.0 / 1371.0 / 1375.0 / 1383.0 / 1385.0	 3512 MEDIDA: 15,2x10,5x6,2mm SERRA MARMORE OEM: 900611036 MOD: 1504.1	 3501 MEDIDA: 19,1x10,5x6,5mm SERRA MARMORE MOD: 301 / 3011	 3516 MEDIDA: 12,7x8x5mm FURADERA OEM: 14189 / 6016 BR / PLANA MOD: 900 B / SERRA CIRCULAR MOD: 400 B / 410 B / 430 BV / LIXADERA DE CINTA MOD: 9031 / 9031E	 3517 MEDIDA: 18,3x13,6x6,4mm LIXADERA OEM: 18151 MOD: 3025 / ESMERLHADERA MOD: 9007 / 9005 / 9105 / SERRA CIRCULAR MOD: 1600 / 1614 / SERRA MARMORE MOD: 4107 / 3612/8600 / 8600 N /
 3473 MEDIDA: 10,5x3,5x5mm SERRA MARMORE OEM: 03121 MOD: 4100 N / SERRA CIRCULAR MOD: 4200 N / 4200 H / 5800 N // LIXADERA MOD: 321.8 / LIXADERA DE CINTA MOD: 9045 B / 9045 NB / 8700 N / 9045 B / 9045 N	 3478 MEDIDA: 11,5x7,38x5mm FURADERA OEM: 15914 / HP 1200 S / DP 1730 / DP 1750 / 6510 BVR / SERRA CIRCULAR MOD: 85142 / 8510 / 5010 / 9035 / 9035R MOD: 321 / 321.8 LIXADERA DE CINTA MOD: 9045 B / 9045 NB / 8700 N / 9045 B / 9045 N	 3499 MEDIDA: 12,5x7,38x5mm ESMERLHADERA OEM: 03219 / 9045 B / 9044 / 9050 N / 9300 NH / 9803 / 9A 300 R / 05 1660 / 9045	 3525 MEDIDA: 17,0x10,8x5mm ESMERLHADERA OEM: 1617000394 / 95549557 MOD: 085 950 / MARTELETO MOD: 902450/2470	 3523 MEDIDA: 12,7x3,8x5mm ESMERLHADERA MOD: 1120	 3527 MEDIDA: 13,8x,8x5mm ESMERLHADERA MOD: 1120



▶ FITA ISOLANTE ANTI-CHAMA



CODIGO	MEDIDA
3629	19MMX5MTS
3630	19MMX10MTS
3631	19MMX20MTS

▶ FITA ISOLANTE IMPERIAL ANTI-CHAMA



CODIGO	MEDIDA
9453	18MMX5MTS
9460	18MMX10MTS
9461	18MMX20MTS

▶ FITA DUPLA FACE VERDE VHB



CODIGO	MEDIDA
10864	9,5MM X 5M
10865	9,5MM X 20M
10866	12MM X 20M
10867	25MM X 20M

▶ FITA DUPLA FACE 3M VERMELHA CARTELA COM 10 PECAS



CODIGO	MEDIDA
10868	11MM X 90CM

▶ FITA CREPE AMARELA 3M ALTA PERFORMANCE



CODIGO	MEDIDA
9567	18MM X 40M

▶ FITA VEDA ROSCA



CODIGO	MEDIDA
3632	12MMX5M (1/2X5M)
3633	12MMX10M (1/2X10M)
3634	12MMX25M (1/2X25M)
3635	12MMX50M (1/2X50M)
3636	18MMX5M (3/4X5M)
3637	18MMX10M (3/4X10M)
3638	18MMX25M (3/4X25M)
3639	18MMX50M (3/4X50M)



▶ **PROTECTOR PARA VOLANTE (EMBALA TUDO)**



CODIGO	MEDIDA
7338	Aprox. 200 M

▶ **CAPA LISA P/BANCO BOBINA 4 KILOS**



CODIGO	Capas
7337	Aprox. 140

▶ **EXPOSITOR DE BOBINA DE CAPA DE BANCO**



CODIGO	MEDIDA
10664	-

▶ **ESTOPA BRANCA 150G**



CODIGO	PESO
7339	150 GRAMAS

▶ **MALHA COSTURADA (FARDO C/25 KG)**



CODIGO	PESO
7340	25 KILOS

▶ **PANO DE MICROFRIBRA**



CODIGO	MEDIDA
9515	40X40 CETIMETROS



▶ **PONTA MONTADA
A3 OXIDO
ALUMINIO**



MED. HASTE: (1/4)6,40 X40

CODIGO MED. PONTA
3562 22X70

▶ **PONTA MONTADA
A5 OXIDO
ALUMINIO**



MED. HASTE: (1/4)6,40 X40

CODIGO MED. PONTA
3563 22X30

▶ **PONTA MONTADA
A11 OXIDO
ALUMINIO**



MED. HASTE: (1/4)6,40 X40

CODIGO MED. PONTA
3564 22X45

▶ **PONTA MONTADA
A12 OXIDO
ALUMINIO**



MED. HASTE: (1/4)6,40 X40

CODIGO MED. PONTA
3565 18X30

▶ **PONTA MONTADA
A15 OXIDO
ALUMINIO**



MED. HASTE: (1/4)6,40 X40

CODIGO MED. PONTA
3566 6X27

▶ **PONTA MONTADA
A24 OXIDO
ALUMINIO**



MED. HASTE: (1/4)6,40 X40

CODIGO MED. PONTA
3567 6X20

▶ **PONTA MONTADA
A26 OXIDO
ALUMINIO**



MED. HASTE: (1/4)6,40 X40

CODIGO MED. PONTA
3568 16X16

▶ **PONTA MONTADA
A40 OXIDO
ALUMINIO**



MED. HASTE: (1/4)6,40 X40

CODIGO MED. PONTA
3569 20X20

▶ **PONTA MONTADA
B41 OXIDO
ALUMINIO**



MED. HASTE: (1/8)3,20 X40

CODIGO MED. PONTA
3570 16X16

▶ **PONTA MONTADA
B52 OXIDO
ALUMINIO**



MED. HASTE: (1/8)3,20 X40

CODIGO MED. PONTA
3571 10X20

▶ **PONTA MONTADA
B97 OXIDO
ALUMINIO**



MED. HASTE: (1/8)3,20 X40

CODIGO MED. PONTA
3572 2,50X10

▶ **PONTA MONTADA
B135 OXIDO
ALUMINIO**



MED. HASTE: (1/8)3,20 X40

CODIGO MED. PONTA
3573 6X13

▶ **PONTA MONTADA
C196 OXIDO
ALUMINIO**



MED. HASTE: (1/4)6,40 X40

CODIGO MED. PONTA
3574 16X25

▶ **PONTA MONTADA
C204 OXIDO
ALUMINIO**



MED. HASTE: (1/4)6,40 X40

CODIGO MED. PONTA
3575 20X20

▶ **PONTA MONTADA
C220 OXIDO
ALUMINIO**



MED. HASTE: (1/4)6,40 X40

CODIGO MED. PONTA
3576 35X35

▶ **PONTA MONTADA
C221 OXIDO
ALUMINIO**



MED. HASTE: (1/4)6,40 X40

CODIGO MED. PONTA
3577 25X38

▶ **PONTA MONTADA
C238 OXIDO
ALUMINIO**



MED. HASTE: 6,40 X40

CODIGO MED. PONTA
3578 38X38



▶ **JOGO DE PONTA MONTADA**



• Indicada para retificar e desbastar pequenas peças com retificadeiras em ferramentaria, fundições, acabamento de furos.

CODIGO COMPOSIÇÃO
10522 5 PEÇAS

▶ DISCO DE CORTE



CODIGO	MEDIDA
3623	4.1/2"X3/64"X7/8" - 115X1,0X22,2MM
3624	4.1/2"X1/8"X7/8" - 115X3,0X22,2MM
3625	7"X1/16"X7/8" - 180X1,6X22,2MM
3626	7"X1/8"X7/8" - 180X3,2X22,2MM

▶ DISCO DE DESBASTE



CODIGO	MEDIDA
3627	4.1/2"X1/4"X7/8" - 115X6,4X22,2MM
3628	7"X1/4"X7/8" - 180X6,4X22,2MM

▶ DISCO FLAP



CODIGO	MEDIDA
3613	115X22MM GRÃO 40
3614	115X22MM GRÃO 60
3615	115X22MM GRÃO 80
3616	115X22MM GRÃO 100
3617	115X22MM GRÃO 120
3618	180X22MM GRÃO 40
3619	180X22MM GRÃO 60
3620	180X22MM GRÃO 80
3621	180X22MM GRÃO 100
3622	180X22MM GRÃO 120

▶ MINI RODA DE LIXAS



CODIGO	MEDIDA
9142	25X25MM GRÃO 36
9143	25X25MM GRÃO 50
9144	25X25MM GRÃO 60
9145	25X25MM GRÃO 80
9146	25X25MM GRÃO 100
9147	25X25MM GRÃO 120
9148	40X25MM GRÃO 36
9149	40X25MM GRÃO 50
9150	40X25MM GRÃO 60
9151	40X25MM GRÃO 80
9152	40X25MM GRÃO 100
9153	40X25MM GRÃO 120
9154	50X25MM GRÃO 36
9155	50X25MM GRÃO 50
9156	50X25MM GRÃO 60
9157	50X25MM GRÃO 80
9158	50X25MM GRÃO 100
9159	50X25MM GRÃO 120
9160	60X25MM GRÃO 36
9161	60X25MM GRÃO 50
9162	60X25MM GRÃO 60
9163	60X25MM GRÃO 80
9164	60X25MM GRÃO 100
9165	60X25MM GRÃO 120
9166	70X25MM GRÃO 36
9167	70X25MM GRÃO 50
9168	70X25MM GRÃO 60
9169	70X25MM GRÃO 80
9170	70X25MM GRÃO 100
9171	70X25MM GRÃO 120



▶ LIXA FERRO



▶ LIXA MASSA / MADEIRA



▶ LIXA D'AGUA

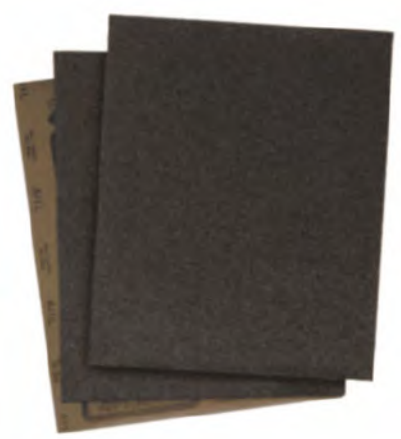

CODIGO	MEDIDA
3603	GRÃO 36
3604	GRÃO 40
3605	GRÃO 50
3606	GRÃO 60
3607	GRÃO 80
3608	GRÃO 100
3609	GRÃO 120
3610	GRÃO 150
3611	GRÃO 180
3612	GRÃO 220

CODIGO	MEDIDA
3596	GRÃO 60
3597	GRÃO 80
3598	GRÃO 100
3599	GRÃO 120
3600	GRÃO 150
3601	GRÃO 180
3602	GRÃO 220

CODIGO	MEDIDA
3579	GRÃO 80
3580	GRÃO 100
3581	GRÃO 120
3582	GRÃO 150
3583	GRÃO 180
3584	GRÃO 220
3585	GRÃO 240
3586	GRÃO 280
3587	GRÃO 320
3588	GRÃO 360
3589	GRÃO 400
3590	GRÃO 600
3591	GRÃO 1200
3592	GRÃO 1500
3593	GRÃO 2000
3594	GRÃO 2500
3595	GRÃO 3000

▶ DISCO DE LIXA



- O disco de lixa é usado para lixar ou polir superfícies de madeira, metal, plástico e outros materiais.
- Discos de lixa com granulações menores são mais adequados para remover camadas de material grossas, enquanto discos com granulações mais finas são usados para acabamento de superfícies mais suaves.

CODIGO	MEDIDA
9432	115X22MM GRAO 16
9433	115X22MM GRAO 24
9434	115X22MM GRAO 36
9435	115X22MM GRAO 40
9436	115X22MM GRAO 50
9437	115X22MM GRAO 60
9438	115X22MM GRAO 80
9439	115X22MM GRAO 100
9440	115X22MM GRAO 120
9441	180X22MM GRAO 16
9442	180X22MM GRAO 24
9443	180X22MM GRAO 36
9444	180X22MM GRAO 40
9445	180X22MM GRAO 50
9446	180X22MM GRAO 60
9447	180X22MM GRAO 80
9448	180X22MM GRAO 100
9449	180X22MM GRAO 120

▶ SUPORTE DISCO DE LIXA



• Suporte para discos de lixa com flange M14

CODIGO	MEDIDA
9508	115MM
9509	180MM



▶ REBOLO USO GERAL PARA ESMERIL



- Indicado para afiação, rebarbação e desbaste, possui alto poder de remoção, rendimento e ótimo custo benefício.
- É indicada para uso em serralherias, oficinas mecânicas, indústrias, etc.

CODIGO	MEDIDA
9172	6" X 1.1/4" X 3/4" GRÃO 36
9173	6" X 1.1/4" X 3/4" GRÃO 46
9174	6" X 1.1/4" X 3/4" GRÃO 60
9175	6" X 1.1/4" X 1" GRÃO 36
9176	6" X 1.1/4" X 1" GRÃO 46
9177	6" X 1.1/4" X 1" GRÃO 60

▶ REBOLO DE VIDIA PARA ESMERIL



- Indicado para afiação de brocas de aço rápido, brocas de vidia e ferramentas de usinagem em geral.
- É um rebole de baixa geração de calor e contaminação, indicado para uso em serralherias, oficinas mecânicas, indústrias, etc.

CODIGO	MEDIDA
9178	6" X 1.1/4" X 3/4" GRÃO 100
9179	6" X 1.1/4" X 3/4" GRÃO 120
9180	6" X 1.1/4" X 1" GRÃO 100
9181	6" X 1.1/4" X 1" GRÃO 120

▶ ESCOVA CIRCULAR DE AÇO PARA ESMERIL



CODIGO	MEDIDA
9182	8" X 1" - 150MM X 25MM



▶ JOGO DE ESCOVA LATONADA



- Aço carbono latonado
- Haste diâmetro 1/4"

CODIGO	COMPOSIÇÃO
9339	3 PEÇAS

▶ JOGO DE LIMA ROTATIVA PARA MADEIRA



- Jogo de lima rotativa com ponta Widea/metal duro é fabricado em metal resistente, utilizado para desbaste e acabamento em madeira em conjunto com uma ferramenta elétrica para uma produção ágil e em grande quantidade
- :: 1 Lima Rotativa Cilíndrica com Corte no Topo
- :: 1 Lima Rotativa Esférica
- :: 1 Lima Rotativa Cilíndrica com Topo Esférico
- :: 1 Lima Rotativa tipo Árvore
- :: 1 Lima Rotativa Cônica

CODIGO	COMPOSIÇÃO
9315	5 PEÇAS

▶ ESCOVA DE AÇO COM CABO DE MADEIRA



- Aço carbono
- Cabo de madeira

CODIGO	COMPOSIÇÃO
9312	3 FILEIRAS

▶ PARAFUSO AUTO BROCANTE PARA TELHA DE ALUMINIO



▶ PARAFUSO AUTO BROCANTE COM ARRUELA

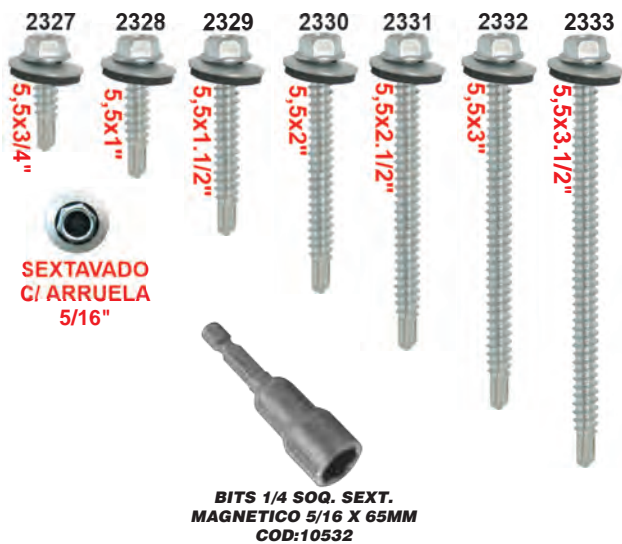

▶ PARAFUSO CABEÇA REDONDA SIX-LOBE

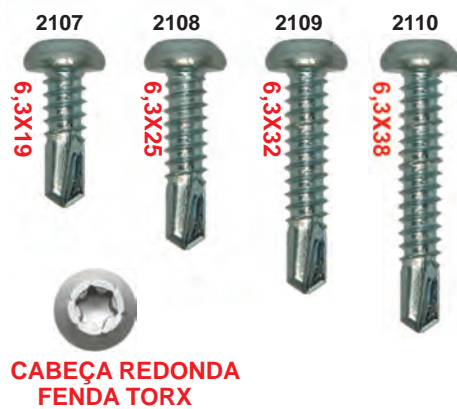

▶ PARAFUSO PARA TELHA COMPLETO



▶ HASTE PESCADOR COMPLETO



▶ HASTE RETA COMPLETA



CODIGO	MEDIDA
2313	5/16"X110MM
2314	5/16"X130MM
2315	5/16"X150MM

CODIGO	MEDIDA
2306	1/4"X85X20MM
2307	1/4"X100X20MM
2308	1/4"X120X20MM

CODIGO	MEDIDA
2309	1/4"X300MM
2310	1/4"X300MM
2311	1/4"X300MM
2312	5/16"X150MM

▶ **ARRUELA DE VEDAÇÃO CONCAVA PARA TELHA**



CODIGO	MEDIDA
2334	1/4"
2335	5/16"

▶ **ARRUELA DE VEDAÇÃO CONCAVA PVC PARA TELHA**



CODIGO	MEDIDA
2336	1/4"
2337	5/16"

▶ **ARRUELA DE VEDAÇÃO RETA PVC PARA TELHA**

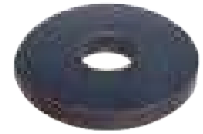

CODIGO	MEDIDA
2338	1/4"

▶ **PORCA GARRA PARA MOVEIS**



CODIGO	MEDIDA
2339	1/4"
2340	5/16"

▶ **PORCA ELIPTICA P/ ANDAIME**



CODIGO	MEDIDA
2341	1/4"

▶ **PARAFUSO CABEÇA ELIPTICA RETO P/ ANDAIMÉ**



CODIGO	MEDIDA
2211	1/2"X4.1/2" BSW

▶ **PARAFUSO CABEÇA ELIPTICA CURVO P/ ANDAIME**



CODIGO	MEDIDA
2212	1/2"X4.1/2" BSW



▶ **PARAFUSO CAMA FENDADO COMPLETO**



▶ PARAFUSO CAMA FURADO COMPLETO

▶ PARAFUSOS PARA VASO SANITÁRIO



CODIGO	MEDIDA
9138	LUXO S-8
9139	LUXO S-10
9140	LUXO S-12

▶ ANEL DE VEDAÇÃO PARA VASO SANITARIO

CODIGO	DESCRIÇÃO
9141	COM GUIA

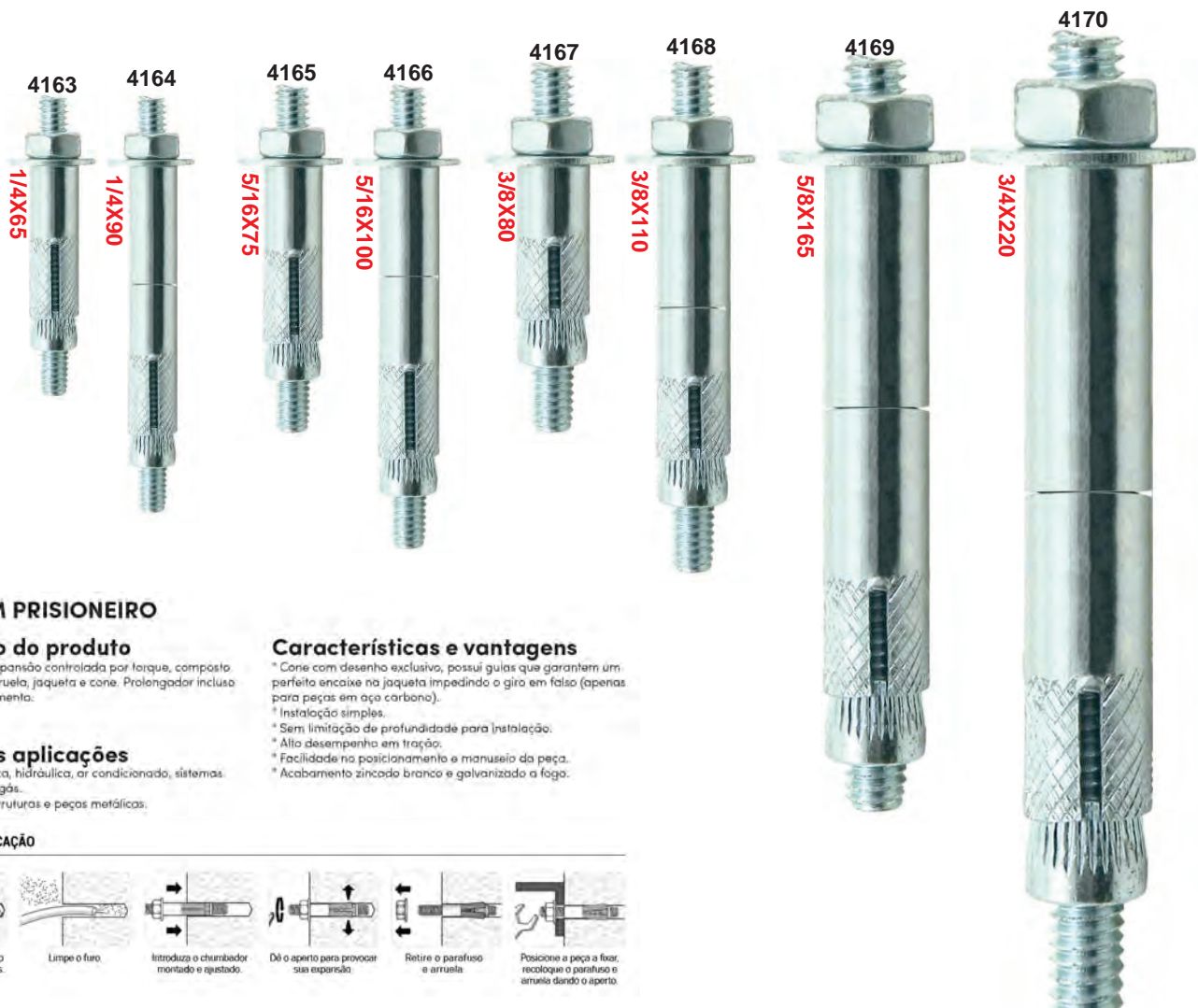

► CHUMBADOR CBA COM PRISONEIRO



CBA COM PRISONEIRO

Descrição do produto

Chumbador de expansão controlada por torque, composto por prisioneiro, arruela, jaqueta e cone. Prolongador incluso conforme comprimento.

Principais aplicações

* Instalação elétrica, hidráulica, ar condicionado, sistemas contra incêndio e gás.
* Instalação de estruturas e peças metálicas.

Características e vantagens

- * Cone com desenho exclusivo, possui guias que garantem um perfeito encaixe na jaqueta impedindo o giro em falso (apenas para peças em aço carbono).
- * Instalação simples.
- * Sem limitação de profundidade para instalação.
- * Alto desempenho em tração.
- * Facilidade no posicionamento e manuseio da peça.
- * Acabamento zincado branco e galvanizado a fogo.

MÉTODO DE APLICAÇÃO



► CHUMBADOR PBA COM PORCA E ARRUELA

PBA

Descrição do produto

Chumbador de expansão controlada por torque. Composto de parafuso expansor, preliha, porca e arruela lisas.

Principais aplicações

- * Fixação de máquinas e equipamentos.
- * Elevadores, plataformas, pontes rolantes.
- * Estruturas metálicas.
- * Sistemas de armazenagem e movimentação.
- * Guarda-corpos, corrimões e apoios.

Características e vantagens

- * Chumbador de melhor desempenho na ancoragem mecânica.
- * Utilizado em montagens passantes.
- * Diâmetro do broco igual ao do chumbador.
- * Aplicação de carga imediato.
- * Sem limitação de profundidade para instalação.
- * Ponta de impacto.

MÉTODO DE APLICAÇÃO

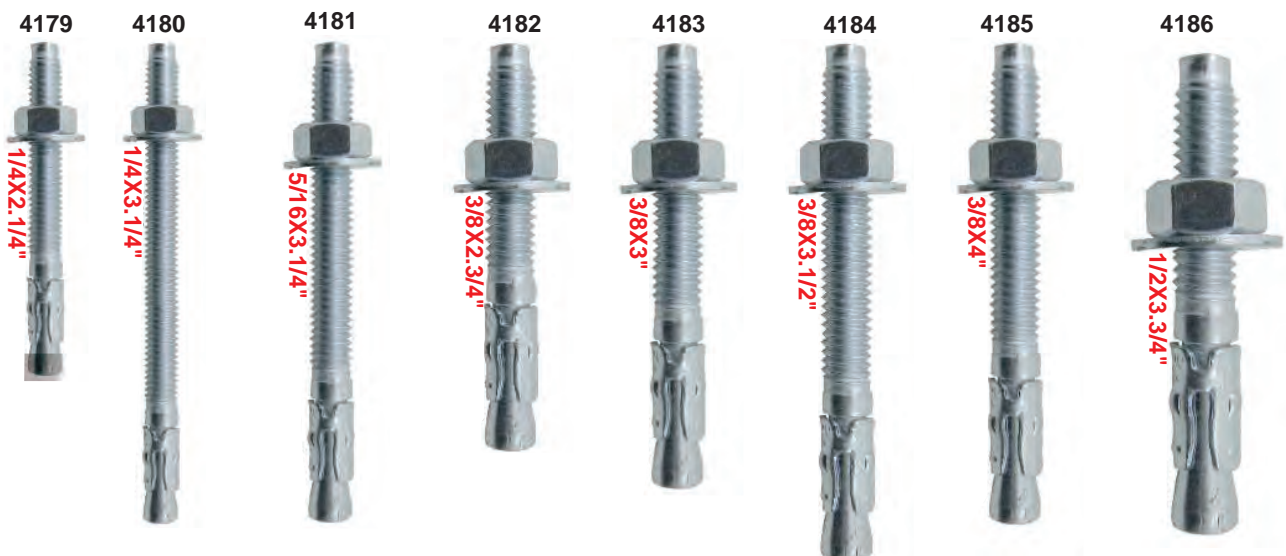
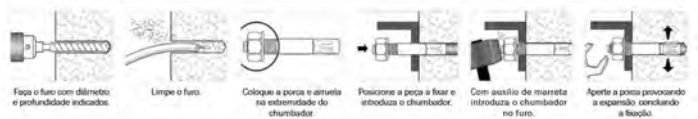

► CHUMBADOR CBA COM PARAFUSO



CBA COM PARAFUSO

Descrição do produto

Chumbador de expansão controlado por torque, composto por prisioneiro, arruela, jaqueta e cone. Prolongador incluso conforme comprimento.

Principais aplicações

* Instalação elétrica, hidráulica, ar condicionado, sistemas contra incêndio e gás.
* Instalação de estruturas e peças metálicas.

Características e vantagens

* Cone com desenho exclusivo, possui guias que garantem um perfeito encaixe na jaqueta impedindo o giro em falso (apenas para peças em aço carbono).
* Instalação simples.
* Sem limitação de profundidade para instalação.
* Alto desempenho em tração.
* Acabamento zincado branco e galvanizado a fogo.

MÉTODO DE APLICAÇÃO



► REBITE SEXTAVADO COM ROSCA INTERNA



CODIGO	MEDIDA
2424	4MM
2425	5MM
2426	6MM
2427	8MM
2428	10MM

► REBITE CILINDRICO COM ROSCA INTERNA



CODIGO	MEDIDA
2429	4MM
2430	5MM
2431	6MM
2432	8MM
2433	10MM

► REBITADEIRA PARA REBITE DE ROSCA



- Rebitador profissional
- Uso industrial e automotivo
- Rosqueamento e desrosqueamento rápido
- Usado onde é necessário fixação com parafusos e porcas, porém com difícil acesso
- Para rebites cilíndricos com as seguintes medidas:
:: M4 – M5 – M6 – M8 – M10

CODIGO	MEDIDA
10523	475MM

► ALICATE REBITADOR PARA REBITE DE ROSCA



- Os rebites de alumínio, aço (M3, M4, M5, M6) ou aço inoxidável (M3, M4, M5) permitem fixar com firmeza chapas brutas, perfis metálicos e estruturas leves

CODIGO	MEDIDA
10524	250MM

▶ REBITE REPUXO ALUMINIO

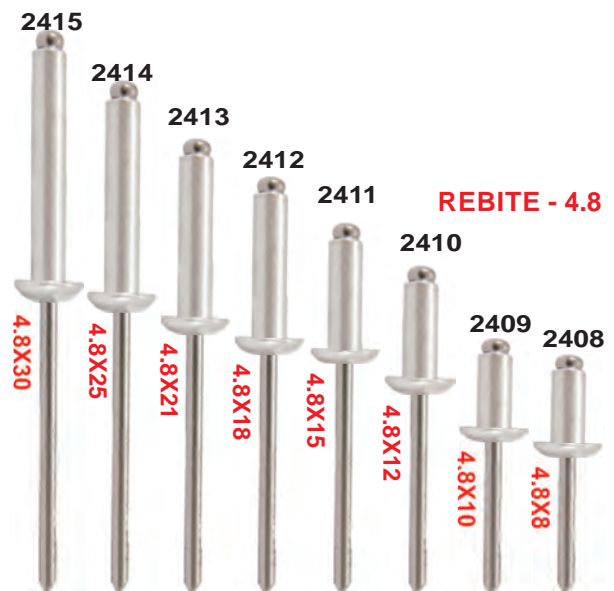
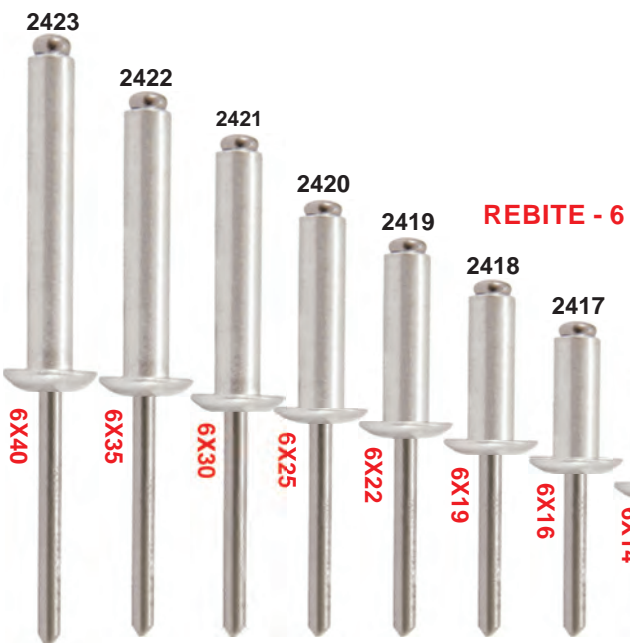
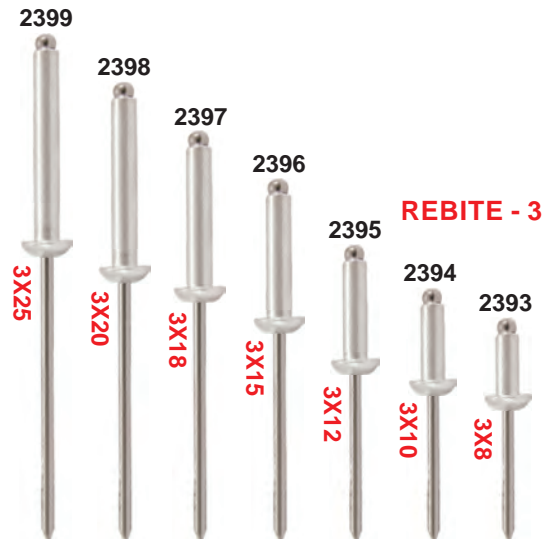
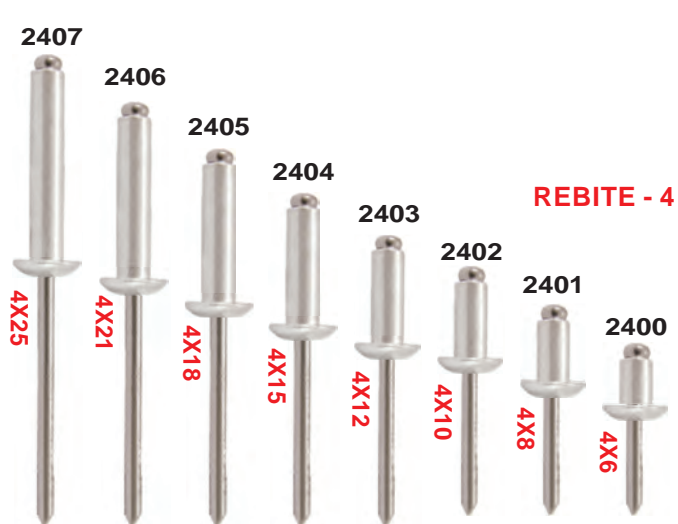

▶ ALICATE REBITADOR



CODIGO	MEDIDA
10415	250MM

▶ ALICATE REBITADOR ROBUST

ROBUST ▶



CODIGO	MEDIDA
9426	250MM

▶ ALICATE REBITADOR CABEÇA GIRATORIA



CODIGO	MEDIDA
10416	263MM

▶ MALETA DE ANEIS ORING AZUL MILIMETRO

▶ MALETA DE ANEIS ORING VERMELHO POLEGADA

CODIGO
COMPOSIÇÃO

9350

MATELA COM 428 PEÇAS

CODIGO
COMPOSIÇÃO

9351

382 PEÇAS

COMPOSIÇÃO MALETA ANEIS ORIN AZUL

CODIGO	REF.	MEDIDA	QTD
9393	7678	3,00mm x 1,50mm	24 pcs
9397	7527	4,00mm x 1,50mm	24 pcs
9398	7239	5,00mm x 1,50mm	23 pcs
9399	7176	6,00mm x 2,00mm	17 pcs
9400	7536	7,00mm x 2,00mm	17 pcs
9401	7388	8,00mm x 2,00mm	17 pcs
9402	7208	9,00mm x 2,00mm	17 pcs
9403	7236	10,00mm x 2,00mm	17 pcs
9404	7303	11,00mm x 2,50mm	14 pcs
9405	7229	12,00mm x 2,50mm	14 pcs
9406	7357	14,00mm x 2,50mm	14 pcs
9407	7274	15,00mm x 2,50mm	14 pcs
9408	7405	17,00mm x 2,50mm	14 pcs
9409	7437	19,00mm x 3,00mm	14 pcs
9410	7453	20,00mm x 3,00mm	11 pcs
9411	7634	21,00mm x 3,00mm	12 pcs
9412	1358	22,00mm x 3,00mm	12 pcs
9413	7359	24,00mm x 3,00mm	12 pcs
9414	7198	26,00mm x 3,00mm	12 pcs
9415	7323	27,00mm x 3,00mm	12 pcs
9416	7011	28,50mm x 3,00mm	12 pcs
9417	7325	30,00mm x 3,00mm	12 pcs
9418	7326	32,00mm x 3,00mm	12 pcs
9419	7304	34,40mm x 3,00mm	12 pcs
9420	7288	35,00mm x 3,00mm	12 pcs
9421	7361	36,00mm x 3,03mm	12 pcs
9422	7577	38,00mm x 3,00mm	12 pcs
9423	7417	42,00mm x 3,00mm	12 pcs
9424	7596	45,00mm x 3,00mm	12 pcs
9425	7009	48,50mm x 3,00mm	12 pcs

COMPOSIÇÃO MALETA ANEIS ORIN VERMELHA

CODIGO	REF.	MEDIDA	QTD
9363	2006	2,90mm x 1,78mm	20 pcs
9364	2007	3,68mm x 1,78mm	20 pcs
9365	2008	4,47mm x 1,78mm	20 pcs
9366	2009	5,28mm x 1,78mm	20 pcs
9367	2010	6,07mm x 1,78mm	20 pcs
9368	2011	7,65mm x 1,78mm	20 pcs
9369	2012	9,25mm x 1,78mm	20 pcs
9370	2110	9,19mm x 2,62mm	13 pcs
9371	2111	10,77mm x 2,62mm	13 pcs
9372	2112	12,37mm x 2,62mm	13 pcs
9373	2113	13,94mm x 2,62mm	13 pcs
9374	2114	15,54mm x 2,62mm	13 pcs
9375	2115	17,12mm x 2,62mm	13 pcs
9376	2116	18,72mm x 2,62mm	13 pcs
9377	2210	18,64mm x 3,53mm	10 pcs
9378	2211	20,22mm x 3,53mm	10 pcs
9379	2212	21,82mm x 3,53mm	10 pcs
9380	2213	23,39mm x 3,53mm	10 pcs
9381	2214	24,99mm x 3,53mm	10 pcs
9382	2215	26,57mm x 3,53mm	10 pcs
9383	2216	28,17mm x 3,53mm	10 pcs
9384	2217	29,74mm x 3,53mm	10 pcs
9385	2218	31,34mm x 3,53mm	10 pcs
9386	2219	32,92mm x 3,53mm	10 pcs
9387	2220	34,52mm x 3,53mm	10 pcs
9388	2221	36,09mm x 3,53mm	10 pcs
9389	2222	37,69mm x 3,53mm	10 pcs
9390	2325	37,47mm x 5,33mm	7 pcs
9391	2326	40,64mm x 5,33mm	7 pcs
9392	2327	43,82mm x 5,33mm	7 pcs

▶ **MALETA DE ANEIS ORING SILICONE MILIMETRO**



CODIGO **COMPOSIÇÃO**

9352 428 PEÇAS

▶ **MALETA DE ANEIS ORING SILICONE POLEGADA**



CODIGO **COMPOSIÇÃO**

9353 382 PEÇAS

▶ **MALETA DE ANEIS ORING CATERPILLAR NBR90B**



CODIGO **COMPOSIÇÃO**

9354 396 PEÇAS

▶ **MALETA DE ANEIS ORING KOMATSU NBR90B**



CODIGO **COMPOSIÇÃO**

9355 435 PEÇAS

▶ **MALETA DE ANEIS ORING VOLVO/ HYUNDAI/ DAEWOO/ DOOSAN NBR90B**



CODIGO **COMPOSIÇÃO**

9356 376 PEÇAS

▶ **MALETA DE ANEIS ORING CASE/ FIAT/ NEW HOLLAND/ HITACHI NBR90B**



CODIGO **COMPOSIÇÃO**

9357 383 PEÇAS

▶ **MALETA DE ANEIS STANDARD TERMINAIS/ADAPTADORES (NBR)**



CODIGO **COMPOSIÇÃO**

9358 988 PEÇAS

▶ **MALETA DE ANEIS STANDARD/ METRICO JOHN DEERE**



CODIGO **COMPOSIÇÃO**

9359 1015 PEÇAS

▶ **MALETA DE ANEIS ORING JCB NBR90B**



CODIGO **COMPOSIÇÃO**

9360 396 PEÇAS

▶ **MALETA DE ANEIS ORING SANY NBR90B**



▶ **MALETA DE ANEIS ORING XCMG NBR90B**



CODIGO	COMPOSIÇÃO
9361	447 PEÇAS

CODIGO	COMPOSIÇÃO
9362	376 PEÇAS

▶ **ANEL ORING EM METRO**



CODIGO	MEDIDA
2788	1,5MM
2789	2,0MM
2790	2,5MM
2791	3,0MM
2792	3,5MM
2793	4,0MM
2794	4,5MM
2795	5,0MM
2796	5,5MM
2797	6,0MM
2798	6,5MM
2799	7,0MM



► GRAXEIRO RETO



► GRAXEIRO CURVO 45 GRAUS



► GRAXEIRO CURVO 90 GRAUS



CODIGO	MEDIDA
2362	M-6X1,0 CURTO
2363	M-8X1,0 CURTO
2364	M-8X1,25 CURTO
2365	M-10X1,0 CURTO
2366	POL-1/8" GAZ (3/8)
2367	POL-1/4"X28 CURTO
2368	POL-5/16"X24 CURTO
2369	POL-3/8"X24 CURTO
2370	POL-7/16" CURTO
2371	POL-1/2"X20 CURTO

CODIGO	MEDIDA
2372	M-6X1,0 CURTO
2373	M-8X1,0 CURTO
2374	M-8X1,25 CURTO
2375	M-10X1,0 CURTO
2376	POL-1/8" GAZ (3/8)
2377	POL-1/4"X28 CURTO
2378	POL-5/16"X24 CURTO
2379	POL-3/8"X24 CURTO
2380	POL-7/16" CURTO
2381	POL-1/2"X20 CURTO

CODIGO	MEDIDA
2383	M-6X1,0 CURTO
2384	M-8X1,0 CURTO
2385	M-8X1,25 CURTO
2386	M-10X1,0 CURTO
2387	POL-1/8" GAZ (3/8)
2388	POL-1/4"X28 CURTO
2389	POL-5/16"X24 CURTO
2390	POL-3/8"X24 CURTO
2391	POL-7/16" CURTO
2392	POL-1/2"X20 CURTO

► KIT DE GRAXEIROS RETOS E CURVOS

Codigo: 10634

- Ideal para seu balção
- Compacto
- 675 peças



**675
PEÇAS**



CODIGO	COMPOSIÇÃO	QTD.
2362	GRAXEIRO RETO M-6X1,0 CURTO	25
2364	GRAXEIRO RETO M-8X1,25 CURTO	25
2365	GRAXEIRO RETO M-10X1,0 CURTO	25
2366	GRAXEIRO RETO POL-1/8" GAZ (3/8)	25
2367	GRAXEIRO RETO POL-1/4"X28 CURTO	25
2368	GRAXEIRO RETO POL-5/16"X24 CURTO	25
2369	GRAXEIRO RETO POL-3/8"X24 CURTO	25
2370	GRAXEIRO RETO POL-7/16" CURTO	25
2371	GRAXEIRO RETO POL-1/2"X20 CURTO	25
2372	GRAXEIRO CURVO 45 GRAUS M-6X1,0 CURTO	25
2374	GRAXEIRO CURVO 45 GRAUS M-8X1,25 CURTO	25
2375	GRAXEIRO CURVO 45 GRAUS M-10X1,0 CURTO	25
2376	GRAXEIRO CURVO 45 GRAUS POL-1/8" GAZ (3/8)	25
2377	GRAXEIRO CURVO 45 GRAUS POL-1/4"X28 CURTO	25
2378	GRAXEIRO CURVO 45 GRAUS POL-5/16"X24 CURTO	25
2379	GRAXEIRO CURVO 45 GRAUS POL-3/8"X24 CURTO	25
2380	GRAXEIRO CURVO 45 GRAUS POL-7/16" CURTO	25
2381	GRAXEIRO CURVO 45 GRAUS POL-1/2"X20 CURTO	25
2383	GRAXEIRO CURVO 90 GRAUS M-6X1,0 CURTO	25
2385	GRAXEIRO CURVO 90 GRAUS M-8X1,25 CURTO	25
2386	GRAXEIRO CURVO 90 GRAUS M-10X1,0 CURTO	25
2387	GRAXEIRO CURVO 90 GRAUS POL-1/8" GAZ (3/8)	25
2388	GRAXEIRO CURVO 90 GRAUS POL-1/4"X28 CURTO	25
2389	GRAXEIRO CURVO 90 GRAUS POL-5/16"X24 CURTO	25
2390	GRAXEIRO CURVO 90 GRAUS POL-3/8"X24 CURTO	25
2391	GRAXEIRO CURVO 90 GRAUS POL-7/16" CURTO	25
2392	GRAXEIRO CURVO 90 GRAUS POL-1/2"X20 CURTO	25
10623	ORGANIZADOR COM 42 DIVISOES	1

▶ **GRAXEIRO CURVO 45 GRAUS DUPLO**



CODIGO	MEDIDA
2382	M-10X1,0 CURTO

▶ **BICO ACOPLADOR 4 GARRAS FINO P/ ENGRAXADEIRA**



CODIGO	ROSCA
9427	1/8 NPT

▶ **BICO ACOPLADOR 4 GARRAS FINO LUBEFER P/ ENGRAXADEIRA**



CODIGO	ROSCA
9428	1/8 NPT

▶ **BICO ACOPLADOR P/ CRUZETA P/ ENGRAXADEIRA**



CODIGO	ROSCA
9429	1/8 NPT

▶ **BICO ACOPLADOR TIPO AGULHA P/ ENGRAXADEIRA**



CODIGO	ROSCA
9430	1/8 NPT

▶ **BICO ACOPLADOR COM TRAVA P/ ENGRAXADEIRA**



CODIGO	ROSCA
9431	1/8 NPT

▶ **ENGRAXADEIRA MANUAL 7 KILOS**



CODIGO	CAPACIDADE
9528	7 KILOS

▶ **ENGRAXADEIRA MANUAL 400 GRAMAS**



CODIGO	CAPACIDADE
9529	400 GRAMAS

▶ CONTRA PINO



CODIGO	MEDIDA
9622	1/16X3/8X (1,5X9,52MM)
9621	1/16X9/16 (1,5X14,29MM)
9620	1/16X3/4 (1,5X19,05MM)
9619	1/16X1.1/4 (1,5X31MM)
2434	3/32X5/8" (2,5MMX15MM)
9618	3/32X3/4 (2,5X19MM)
2435	3/32X1" (2,5MMX25MM)
9616	3/32X1.1/4 (2,5X31MM)
2436	3/32X1.1/2" (2,5MMX40MM)
2437	3/32X2" (2,5MMX50MM)
2438	1/8X3/4" (3,2MMX20MM)
2439	1/8X1" (3,2MMX25MM)
2440	1/8X1.1/4" (3,2MMX30MM)
2441	1/8X1.1/2" (3,2MMX40MM)
2442	1/8X2" (3,2MMX50MM)
2443	1/8X2.1/2" (3,2MMX60MM)
2444	5/32X1" (4,0MMX25MM)
9632	5/32X1.1/4 (3,96X32MM)
9631	5/32X1.3/4 (3,96X44MM)
2445	5/32X1.1/2" (4,0MMX40MM)
2446	5/32X2" (4,0MMX50MM)
2447	5/32X2.1/2" (4,0MMX60MM)
9630	5/32X2.3/4 (3,96X70MM)
2448	5/32X3" (4,0MMX80MM)
2449	3/16X1" (5,0MMX25MM)
2450	3/16X1.1/2" (5,0MMX30MM)

▶ CONTRA PINO SORTIDO



CODIGO	COMPOSIÇÃO
2465	1 KILO SORTIDO (VARIAS MEDIDAS)

9629	3/16X1.3/4 (4,76X44MM)
2451	3/16X2" (5,0MMX50MM)
9628	3/16X2.3/8 (4,76X60MM)
2452	3/16X2.1/2" (5,0MMX60MM)
2453	3/16X3" (5,0MMX80MM)
2454	3/16X3.1/2" (5,0MMX90MM)
2455	1/4X1" (6,3MMX25MM)
9627	1/4X1.1/4 (6,35X32,00)
2456	1/4X1.1/2" (6,3MMX30MM)
9626	1/4X1.3/4 (6,35X44,00)
2457	1/4X2" (6,3MMX50MM)
2458	1/4X2.1/2" (6,3MMX60MM)
2459	1/4X3" (6,3MMX80MM)
9625	1/4X3.1/8 (6,35X80MM)
2460	1/4X3.1/2" (6,3MMX90MM)
2461	5/16X2" (8,0MMX50MM)
2462	5/16X2.1/2" (8,0MMX60MM)
2463	5/16X3" (8,0MMX80MM)
2464	5/16X4" (8,0MMX100MM)
9615	3/8X3 (9,52X76MM)
9624	3/8X3.1/2 (9,52X88MM)
9623	3/8X4 (9,52X101MM)

▶ KIT DE CONTRA PINO



Codigo: 10635

CODIGO	COMPOSIÇÃO	QTD.
2439	1/8X1" (3,2MMX25MM)	50
2441	1/8X1.1/2" (3,2MMX40MM)	50
2442	1/8X2" (3,2MMX50MM)	50
2444	5/32X1" (4,0MMX25MM)	50
2445	5/32X1.1/2" (4,0MMX40MM)	50
2446	5/32X2" (4,0MMX50MM)	50
2449	3/16X1" (5,0MMX25MM)	50
2450	3/16X1.1/2" (5,0MMX30MM)	50
2451	3/16X2" (5,0MMX50MM)	50
2455	1/4X1" (6,3MMX25MM)	25
2456	1/4X1.1/2" (6,3MMX30MM)	25
2457	1/4X2" (6,3MMX50MM)	25
2459	1/4X3" (6,3MMX80MM)	25
2461	5/16X2" (8,0MMX50MM)	25
2462	5/16X2.1/2" (8,0MMX60MM)	25
2463	5/16X3" (8,0MMX80MM)	25
10622	ORGANIZADOR COM 16 GAVETAS	1

▶ PINO TRAVA R

CODIGO	MEDIDA
2466	2X40MM
2467	2X50MM
2468	2X60MM
2469	2,5X40MM
2470	2,5X50MM
2471	2,5X60MM
2472	3X55MM
2473	3X60MM
2474	3X70MM
2475	3X75MM
2476	3X80MM
2477	4X75MM
2478	4X80MM
2479	4X90MM
2480	4X100MM
2481	4X110MM
2482	4X120MM
2483	4X130MM
2484	4,5X70MM
2485	4,5X80MM
2486	4,5X90MM
2487	4,5X100MM
2488	5X90MM
2489	5X100MM
2490	5X110MM
2491	5X120MM
2492	6X90MM
2493	6X100MM
2494	6X110MM
2495	6X120MM

▶ PORCA COM ALÇA PARA CARROCERIA

CODIGO	COMPOSIÇÃO
2505	3/4"
2506	5/8"

▶ PINO QUEBRA DEDO

CODIGO	COMPOSIÇÃO
2496	4,5X35MM
2497	5,0X50MM
2498	1/4" X 1.1/2"
2499	1/4" X 2.1/2"
2500	1/4" X 2"
2501	5/16" X 2"
2502	5/16" X 2"
2503	3/8" X 2"
2504	7/16" X 2"

▶ ANEL ELASTICO DE RETENÇÃO

CODIGO	MEDIDA
2669	1,2 MM
2670	1,5 MM
2671	1,9 MM
2672	2,3 MM
2673	3,2 MM
2674	4,0 MM
2675	5,0 MM
2676	6,0 MM
2677	7,0 MM
2678	8,0 MM
2679	9,0 MM
2680	10,0 MM
2681	12,0 MM
2682	15,0 MM
2683	19,0 MM
2684	24,0 MM

▶ ANEL ELASTICO EXTERNO



CODIGO	MEDIDA
2542	6 MM
2543	7 MM
2544	8 MM
2545	9 MM
2546	10 MM
2547	11 MM
2548	12 MM
2549	13 MM
2550	14 MM
2551	15 MM
2552	16 MM
2553	17 MM
2554	18 MM
2555	19 MM
2556	20 MM

2557	21 MM	2579	46 MM
2558	22 MM	2580	47 MM
2559	23 MM	2581	48 MM
2560	24 MM	2585	50 MM
2561	25 MM	2586	52 MM
2562	26 MM	2582	53 MM
2563	28 MM	2583	54 MM
2564	29 MM	2587	55 MM
2565	30 MM	2588	56 MM
2566	31MM	2584	57 MM
2567	32 MM	2589	58 MM
2568	33MM	2590	60 MM
2569	34 MM	2591	62 MM
2570	35 MM	2592	63 MM
2571	36 MM	2593	65 MM
2572	37 MM	2594	68 MM
2573	38 MM	2595	70 MM
2574	39 MM	2596	72 MM
2575	40 MM	2597	75 MM
9645	41 MM	2598	80 MM
2576	42 MM	2599	85 MM
9644	43 MM	2600	90 MM
2577	44 MM	2601	95 MM
2578	45 MM	2602	110 MM

▶ KIT DE ANEL ELASTICO EXTERNO

Codigo: **10637**



**975
PEÇAS**



CODIGO	MEDIDA	QTD.			
2546	10 MM	25	2567	32 MM	25
2547	11 MM	25	2568	33MM	25
2548	12 MM	25	2569	34 MM	25
2549	13 MM	25	2570	35 MM	25
2550	14 MM	25	2571	36 MM	25
2551	15 MM	25	2572	37 MM	25
2552	16 MM	25	2573	38 MM	25
2553	17 MM	25	2574	39 MM	25
2554	18 MM	25	2575	40 MM	25
2555	19 MM	25	9645	41 MM	25
2556	20 MM	25	2576	42 MM	25
2557	21 MM	25	9644	43 MM	25
2558	22 MM	25	2577	44 MM	25
2559	23 MM	25	2578	45 MM	25
2560	24 MM	25	2579	46 MM	25
2561	25 MM	25	2580	47 MM	25
2562	26 MM	25	2581	48 MM	25
2563	28 MM	25	2585	50 MM	25
2564	29 MM	25			
2565	30 MM	25			
2566	31MM	25			
			10623	ORGANIZADOR COM 42 GAVETAS	1

▶ ANEL ELASTICO INTERNO



CODIGO	MEDIDA
2603	10 MM
2604	11 MM
2605	12 MM
2606	13 MM
2607	14 MM
2608	15 MM
2609	16 MM
2610	17 MM
2611	18 MM
2612	19 MM
2613	20 MM
2614	21 MM
2615	22 MM
2616	23 MM
2617	24 MM
2618	25 MM
2619	26 MM

2620	27 MM
2621	28 MM
2622	29 MM
2623	30 MM
2624	31 MM
2625	32 MM
2626	33 MM
2627	34 MM
2628	35 MM
2629	36 MM
2630	37 MM
2631	38 MM
2632	39 MM
2633	40 MM
2634	41 MM
2635	42 MM
2636	43 MM
2637	45 MM
2638	46 MM
2639	47 MM
2640	48 MM
2641	50 MM
2642	52 MM
2643	53 MM
2644	54 MM

2645	55 MM
2646	56 MM
2647	57 MM
2648	58 MM
2649	60 MM
2650	62 MM
2651	63 MM
2652	65 MM
2653	67 MM
2654	68 MM
2655	70 MM
2656	72 MM
2657	75 MM
2658	78 MM
2659	80 MM
2660	85 MM
2661	90 MM
2662	95 MM
2663	100 MM
2664	105 MM
2665	110 MM
2666	115 MM
2667	120 MM
2668	125 MM

▶ KIT DE ANEL ELASTICO INTERNO

Codigo: **10638**



**975
PEÇAS**



CODIGO	MEDIDA	QTD.			
2603	10 MM	25	2624	31 MM	25
2604	11 MM	25	2625	32 MM	25
2605	12 MM	25	2626	33 MM	25
2606	13 MM	25	2627	34 MM	25
2607	14 MM	25	2628	35 MM	25
2608	15 MM	25	2629	36 MM	25
2609	16 MM	25	2630	37 MM	25
2610	17 MM	25	2631	38 MM	25
2611	18 MM	25	2632	39 MM	25
2612	19 MM	25	2633	40 MM	25
2613	20 MM	25	2634	41 MM	25
2614	21 MM	25	2635	42 MM	25
2615	22 MM	25	2636	43 MM	25
2616	23 MM	25	2637	45 MM	25
2617	24 MM	25	2638	46 MM	25
2618	25 MM	25	2639	47 MM	25
2619	26 MM	25	2640	48 MM	25
2620	27 MM	25	2641	50 MM	25
2621	28 MM	25	10623	ORGANIZADOR COM 42 GAVETAS	1
2622	29 MM	25			
2623	30 MM	25			

► KIT DE ANEL ELASTICO PREMIUM

Codigo: 10639



**2625
PEÇAS**

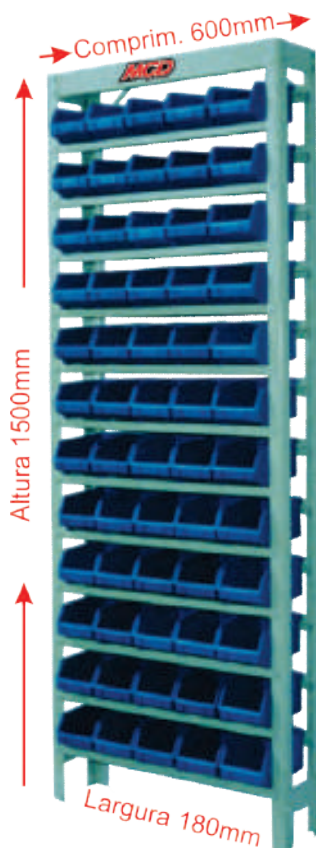

CODIGO	COMPOSIÇÃO	QTD.
2546	ANEL EXTERNO 10 MM	25
2548	ANEL EXTERNO 12 MM	25
2550	ANEL EXTERNO 14 MM	25
2552	ANEL EXTERNO 16 MM	25
2554	ANEL EXTERNO 18 MM	25
2556	ANEL EXTERNO 20 MM	25
2558	ANEL EXTERNO 22 MM	25
2560	ANEL EXTERNO 24 MM	25
2561	ANEL EXTERNO 25 MM	25
2562	ANEL EXTERNO 26 MM	25
2563	ANEL EXTERNO 28 MM	25
2565	ANEL EXTERNO 30 MM	25
2567	ANEL EXTERNO 32 MM	25
2569	ANEL EXTERNO 34 MM	25
2570	ANEL EXTERNO 35 MM	25
2571	ANEL EXTERNO 36 MM	25
2573	ANEL EXTERNO 38 MM	25
2575	ANEL EXTERNO 40 MM	25
2576	ANEL EXTERNO 42 MM	25
2577	ANEL EXTERNO 44 MM	25
2579	ANEL EXTERNO 46 MM	25
2581	ANEL EXTERNO 48 MM	25
2585	ANEL EXTERNO 50 MM	25
2603	ANEL INTERNO 10 MM	25
2605	ANEL INTERNO 12 MM	25
2607	ANEL INTERNO 14 MM	25
2609	ANEL INTERNO 16 MM	25

2611	ANEL INTERNO 18 MM	25
2613	ANEL INTERNO 20 MM	25
2615	ANEL INTERNO 22 MM	25
2617	ANEL INTERNO 24 MM	25
2618	ANEL INTERNO 25 MM	25
2619	ANEL INTERNO 26 MM	25
2621	ANEL INTERNO 28 MM	25
2623	ANEL INTERNO 30 MM	25
2625	ANEL INTERNO 32 MM	25
2627	ANEL INTERNO 34 MM	25
2628	ANEL INTERNO 35 MM	25
2629	ANEL INTERNO 36 MM	25
2631	ANEL INTERNO 38 MM	25
2633	ANEL INTERNO 40 MM	25
2635	ANEL INTERNO 42 MM	25
2637	ANEL INTERNO 45 MM	25
2638	ANEL INTERNO 46 MM	25
2640	ANEL INTERNO 48 MM	25
2641	ANEL INTERNO 50 MM	25
2669	ANEL RETENÇÃO 1,2 MM	100
2670	ANEL RETENÇÃO 1,5 MM	100
2671	ANEL RETENÇÃO 1,9 MM	100
2672	ANEL RETENÇÃO 2,3 MM	100
2673	ANEL RETENÇÃO 3,2 MM	100
2674	ANEL RETENÇÃO 4,0 MM	100
2675	ANEL RETENÇÃO 5,0 MM	100
2676	ANEL RETENÇÃO 6,0 MM	100
2677	ANEL RETENÇÃO 7,0 MM	100
2678	ANEL RETENÇÃO 8,0 MM	100
2679	ANEL RETENÇÃO 9,0 MM	50
2680	ANEL RETENÇÃO 10,0 MM	50
2681	ANEL RETENÇÃO 12,0 MM	50
2682	ANEL RETENÇÃO 15,0 MM	50
10606	ESTANTE COMPLETA COM 60 GAVETAS Nº 3 AZUL	1



▶ CHAVETA TIPO A



CODIGO	MEDIDA
2507	4X4X20
2508	4X4X26
2509	4X4X30
2510	4X4X36
2511	4X4X40
2512	4X4X45
2513	4X4X50
2514	5X5X20
2515	5X5X24
2516	5X5X28
2517	5X5X30
2518	5X5X32
2519	5X5X40
2520	5X5X45

2521	5X5X60
2522	6X6X26
2523	6X6X30
2524	6X6X36
2525	6X6X40
2526	6X6X45
2527	6X6X50
2528	6X6X55
2529	6X6X60
2530	6X6X70
2531	6X6X80
2532	8X8X20
2533	8X8X25
2534	8X8X32
2535	8X8X40
2536	8X8X45
2537	8X8X50
2538	8X8X60
2539	8X8X70
2540	10X10X40
2541	12X12X50

▶ KIT DE CHAVETA TIPO A

Codigo: **10636**



CODIGO	MEDIDA	QTD.			
2507	4X4X20	10	2528	6X6X55	10
2508	4X4X26	10	2529	6X6X60	10
2509	4X4X30	10	2530	6X6X70	10
2510	4X4X36	10	2531	6X6X80	10
2511	4X4X40	10	2532	8X8X20	10
2512	4X4X45	10	2533	8X8X25	10
2513	4X4X50	10	2534	8X8X32	10
2514	5X5X20	10	2535	8X8X40	10
2515	5X5X24	10	2536	8X8X45	10
2516	5X5X28	10	2537	8X8X50	10
2517	5X5X30	10	2538	8X8X60	10
2518	5X5X32	10	2539	8X8X70	10
2519	5X5X40	10	2540	10X10X40	10
2520	5X5X45	10	2541	12X12X50	10
2521	5X5X60	10	10623	ORGANIZADOR COM 42 GAVETAS	1
2522	6X6X26	10			
2523	6X6X30	10			
2524	6X6X36	10			
2525	6X6X40	10			
2526	6X6X45	10			
2527	6X6X50	10			

► PINO ELASTICO



CODIGO	MEDIDA
2685	3X10MM
2686	3X12MM
2687	3X14MM
2688	3X16MM
2689	3X18MM
2690	3X20MM
2691	3X22MM
2692	3X24MM
2693	3X28MM
2694	3X30MM
2695	3X32MM
2696	3X35MM
2697	3X40MM
2698	3,5X26MM
2699	4X10MM
2700	4X12MM
2701	4X14MM
2702	4X18MM
2703	4X20MM
2704	4X22MM
2705	4X24MM
2706	4X26MM
2707	4X28MM
2708	4X30MM
2709	4X32MM
2710	4X36MM
2711	4X40MM
2712	4X45MM
2713	4X50MM

2714	5X16MM
2715	5X18MM
2716	5X20MM
2717	5X22MM
2718	5X24MM
2719	5X26MM
2720	5X28MM
2721	5X30MM
2722	5X32MM
2723	5X35MM
2724	5X40MM
2725	5X45MM
2726	5X50MM
2727	5X60MM
2728	5X70MM
2729	5X80MM
2730	6X16MM
2731	6X20MM
2732	6X22MM
2733	6X24MM
2734	6X26MM
2735	6X28MM
2736	6X30MM
2737	6X32MM
2738	6X40MM
2739	6X45MM
2740	6X50MM
2741	6X60MM
2742	6X65MM
2743	6X70MM
2744	6X75MM
2745	6X80MM
2746	6X90MM
2747	8X24MM
2748	8X30MM
2749	8X32MM
2750	8X36MM
2751	8X40MM

2752	8X45MM
2753	8X50MM
2754	8X58MM
2755	8X60MM
2756	8X65MM
2757	8X70MM
2758	8X75MM
2759	8X80MM
2760	8X85MM
2761	8X90MM
2762	8X100MM
2763	10X20MM
2764	10X24MM
2765	10X30MM
2766	10X32MM
2767	10X36MM
2768	10X40MM
2769	10X45MM
2770	10X50MM
2771	10X55MM
2772	10X60MM
2773	10X65MM
2774	10X70MM
2775	10X75MM
2776	10X80MM
2777	10X85MM
2778	10X90MM
2779	10X100MM
2780	12X50MM
2781	12X55MM
2782	12X60MM
2783	12X65MM
2784	12X70MM
2785	12X75MM
2786	12X80MM
2787	12X90MM



► KIT DE PINO ELASTICO
Codigo: 10640

**420
PEÇAS**

CODIGO	MEDIDA	QTD.
2694	3X30MM	10
2696	3X35MM	10
2697	3X40MM	10
2698	3,5X26MM	10
2700	4X12MM	10
2703	4X20MM	10
2706	4X26MM	10
2707	4X28MM	10
2711	4X40MM	10
2712	4X45MM	10
2713	4X50MM	10
2721	5X30MM	10
2723	5X35MM	10
2724	5X40MM	10
2725	5X45MM	10
2726	5X50MM	10
2727	5X60MM	10
2735	6X28MM	10
2736	6X30MM	10
2737	6X32MM	10
2738	6X40MM	10
2739	6X45MM	10
2740	6X50MM	10
2741	6X60MM	10
2743	6X70MM	10
2745	6X80MM	10
2751	8X40MM	10
2752	8X45MM	10
2753	8X50MM	10
2755	8X60MM	10
2757	8X70MM	10
2759	8X80MM	10
2760	8X85MM	10
2762	8X100MM	10
2770	10X50MM	10
2771	10X55MM	10
2772	10X60MM	10
2774	10X70MM	10
2776	10X80MM	10
2781	12X55MM	10
2782	12X60MM	10
2786	12X80MM	10
10623	ORGANIZADOR COM 42 GAVETAS	1



▶ CORREIA EM V PERFIL A



CODIGO	MEDIDA
2800	A-15
2801	A-16
2802	A-17
2803	A-18
2804	A-19
2805	A-20
2806	A-21
2807	A-22
2808	A-23
2809	A-24
2810	A-25
2811	A-26
2812	A-27
2813	A-28
2814	A-29
2815	A-30
2816	A-31
2817	A-32
2818	A-33
2819	A-34
2820	A-35
2821	A-36
2822	A-37
2823	A-38
2824	A-39
2825	A-40
2826	A-41
2827	A-42
2828	A-43
2829	A-44
2830	A-45
2831	A-46
2832	A-47
2833	A-48
2834	A-49
2835	A-50
2836	A-51
2837	A-52
2838	A-53
2839	A-54

2840	A-55
2841	A-56
2842	A-57
2843	A-58
2844	A-59
2845	A-60
2846	A-61
2847	A-62
2848	A-63
2849	A-64
2850	A-65
2851	A-66
2852	A-67
2853	A-68
2854	A-69
2855	A-70
2856	A-71
2857	A-72
2858	A-73
2859	A-74
2860	A-75
2861	A-76
2862	A-77
2863	A-78
2864	A-79
2865	A-80
2866	A-81
2867	A-82
2868	A-83
2869	A-84
2870	A-85
2871	A-86
2872	A-87
2873	A-88
2874	A-89
2875	A-90
2876	A-91
2877	A-92
2878	A-93
2879	A-94
2880	A-95
2881	A-96
2882	A-97
2883	A-98
2884	A-99
2885	A-100
2886	A-101
2887	A-102
2888	A-103
2889	A-104
2890	A-105
2891	A-106

2892	A-107
2893	A-108
2894	A-109
2895	A-110
2896	A-111
2897	A-112
2898	A-113
2899	A-114
2900	A-115
2901	A-116
2902	A-117
2903	A-118
2904	A-119
2905	A-120
2906	A-121
2907	A-122
2908	A-123
2909	A-124
2910	A-125
2911	A-126
2912	A-127
2913	A-128
2914	A-129
2915	A-130
2916	A-131
2917	A-132
2918	A-135
2919	A-136
2920	A-140
2921	A-144
2922	A-150
2923	A-151
2924	A-155
2925	A-158
2926	A-162
2927	A-165
2928	A-166
2929	A-173
2930	A-180

▶ CORREIA EM V PERFIL B



CODIGO	MEDIDA				
		2970	B-60	3010	B-100
2931	B-21	2971	B-61	3011	B-101
2932	B-22	2972	B-62	3012	B-102
2933	B-23	2973	B-63	3013	B-103
2934	B-24	2974	B-64	3014	B-104
2935	B-25	2975	B-65	3015	B-105
2936	B-26	2976	B-66	3016	B-106
2937	B-27	2977	B-67	3017	B-107
2938	B-28	2978	B-68	3018	B-108
2939	B-29	2979	B-69	3019	B-109
2940	B-30	2980	B-70	3020	B-110
2941	B-31	2981	B-71	3021	B-111
2942	B-32	2982	B-72	3022	B-112
2943	B-33	2983	B-73	3023	B-113
2944	B-34	2984	B-74	3024	B-114
2945	B-35	2985	B-75	3025	B-115
2946	B-36	2986	B-76	3026	B-116
2947	B-37	2987	B-77	3027	B-117
2948	B-38	2988	B-78	3028	B-118
2949	B-39	2989	B-79	3029	B-119
2950	B-40	2990	B-80	3030	B-120
2951	B-41	2991	B-81	3031	B-121
2952	B-42	2992	B-82	3032	B-122
2953	B-43	2993	B-83	3033	B-123
2954	B-44	2994	B-84	3034	B-124
2955	B-45	2995	B-85	3035	B-125
2956	B-46	2996	B-86	3036	B-126
2957	B-47	2997	B-87	3037	B-127
2958	B-48	2998	B-88	3038	B-128
2959	B-49	2999	B-89	3039	B-129
2960	B-50	3000	B-90	3040	B-130
2961	B-51	3001	B-91	3041	B-131
2962	B-52	3002	B-92	3042	B-132
2963	B-53	3003	B-93	3043	B-133
2964	B-54	3004	B-94	3044	B-134
2965	B-55	3005	B-95	3045	B-135
2966	B-56	3006	B-96	3046	B-136
2967	B-57	3007	B-97	3047	B-137
2968	B-58	3008	B-98	3048	B-138
2969	B-59	3009	B-99	3049	B-139
				3050	B-140
				3051	B-141
				3052	B-142
				3053	B-143
				3054	B-144
				3055	B-145
				3056	B-146
				3057	B-147
				3058	B-148
				3059	B-150
				3060	B-151
				3061	B-152
				3062	B-154
				3063	B-155
				3064	B-157
				3065	B-158
				3066	B-159
				3067	B-160
				3068	B-162
				3069	B-163
				3070	B-164
				3071	B-165
				3072	B-168
				3073	B-169
				3074	B-170
				3075	B-172
				3076	B-173
				3077	B-174
				3078	B-175
				3079	B-176
				3080	B-177
				3081	B-178
				3082	B-179
				3083	B-180
				3084	B-183
				3085	B-184
				3086	B-185
				3087	B-188
				3088	B-190
				3089	B-191
				3090	B-194
				3091	B-195
				3092	B-198
				3093	B-200
				3094	B-205
				3095	B-209
				3096	B-210
				3097	B-225
				3098	B-227
				3099	B-240
				3100	B-249
				3101	B-250
				3102	B-255
				3103	B-270
				3104	B-278
				3105	B-300
				3106	B-330
				3107	B-360
				3108	B-420
				3109	B-472

► CORREIA EM V PERFIL C



CODIGO	MEDIDA		
3110	C-041	3148	C-82
3111	C-43	3149	C-83
3112	C-46	3150	C-84
3113	C-47	3151	C-85
3114	C-48	3152	C-86
3115	C-49	3153	C-87
3116	C-50	3154	C-88
3117	C-51	3155	C-89
3118	C-52	3156	C-90
3119	C-53	3157	C-91
3120	C-54	3158	C-92
3121	C-55	3159	C-93
3122	C-56	3160	C-94
3123	C-57	3161	C-95
3124	C-58	3162	C-96
3125	C-59	3163	C-97
3126	C-60	3164	C-98
3127	C-61	3165	C-99
3128	C-62	3166	C-100
3129	C-63	3167	C-101
3130	C-64	3168	C-102
3131	C-65	3169	C-103
3132	C-66	3170	C-104
3133	C-67	3171	C-105
3134	C-68	3172	C-106
3135	C-69	3173	C-107
3136	C-70	3174	C-108
3137	C-71	3175	C-109
3138	C-072	3176	C-110
3139	C-73	3177	C-111
3140	C-74	3178	C-112
3141	C-75	3179	C-113
3142	C-76	3180	C-114
3143	C-77	3181	C-115
3144	C-78	3182	C-116
3145	C-79	3183	C-117
3146	C-80	3184	C-118
3147	C-81	3185	C-119
		3186	C-120
		3187	C-121
		3188	C-122
		3189	C-123
		3190	C-124
		3191	C-125
		3192	C-126
		3193	C-127
		3194	C-128
		3195	C-129
		3196	C-130
		3197	C-131
		3198	C-132
		3199	C-133
		3200	C-134
		3201	C-135
		3202	C-136
		3203	C-137
		3204	C-138
		3205	C-139
		3206	C-140
		3207	C-141
		3208	C-142
		3209	C-143
		3210	C-144
		3211	C-145
		3212	C-146
		3213	C-147
		3214	C-148
		3215	C-149
		3216	C-150
		3217	C-151
		3218	C-152
		3219	C-153
		3220	C-154
		3221	C-155
		3222	C-156
		3223	C-157
		3224	C-158
		3225	C-159
		3226	C-160
		3227	C-161
		3228	C-162
		3229	C-163
		3230	C-164
		3231	C-165
		3232	C-166
		3233	C-167
		3234	C-168
		3235	C-169
		3236	C-170
		3237	C-171
		3238	C-172
		3239	C-173
		3240	C-174
		3241	C-175
		3242	C-176
		3243	C-178
		3244	C-180
		3245	C-181
		3246	C-182
		3247	C-184
		3248	C-185
		3249	C-186
		3250	C-190
		3251	C-192
		3252	C-195
		3253	C-197
		3254	C-198
		3255	C-204
		3256	C-206
		3257	C-208
		3258	C-210
		3259	C-225
		3260	C-240
		3261	C-241
		3262	C-248
		3263	C-250
		3264	C-255
		3265	C-270
		3266	C-280
		3267	C-285
		3268	C-300
		3269	C-315
		3270	C-330
		3271	C-360
		3272	C-390
		3273	C-420
		3274	C-480

▶ CORREIA EM V PERFIL D



CODIGO	MEDIDA
3275	D-091
3276	D-100
3277	D-112
3278	D-114
3279	D-120
3280	D-128
3281	D-136
3282	D-144
3283	D-158
3284	D-162
3285	D-173
3286	D-180
3287	D-195
3288	D-210
3289	D-225
3290	D-240
3291	D-250
3292	D-255
3293	D-270
3294	D-300
3295	D-315
3296	D-320
3297	D-330
3298	D-345
3299	D-360
3300	D-390
3301	D-420
3302	D-436
3303	D-480
3304	D-530

▶ CORREIA EM V PERFIL 3L



CODIGO	MEDIDA
3305	3L-130
3306	3L-140
3307	3L-150
3308	3L-160
3309	3L-170
3310	3L-180
3311	3L-190
3312	3L-200
3313	3L-210
3314	3L-220
3315	3L-230
3316	3L-240
3317	3L-250
3318	3L-260
3319	3L-270
3320	3L-280
3321	3L-290
3322	3L-300
3323	3L-310
3324	3L-320
3325	3L-330
3326	3L-340
3327	3L-350
3328	3L-360

3329	3L-370
3330	3L-380
3331	3L-390
3332	3L-400
3333	3L-410
3334	3L-420
3335	3L-430
3336	3L-440
3337	3L-450
3338	3L-460
3339	3L-470
3340	3L-480
3341	3L-490
3342	3L-500
3343	3L-510
3344	3L-520
3345	3L-530
3346	3L-540
3347	3L-550
3348	3L-560
3349	3L-570
3350	3L-580
3351	3L-590
3352	3L-600
3353	3L-610
3354	3L-620
3355	3L-630
3356	3L-640
3357	3L-650
3358	3L-660
3359	3L-670
3360	3L-680
3361	3L-690
3362	3L-700
3363	3L-710
3364	3L-720
3365	3L-730
3366	3L-740

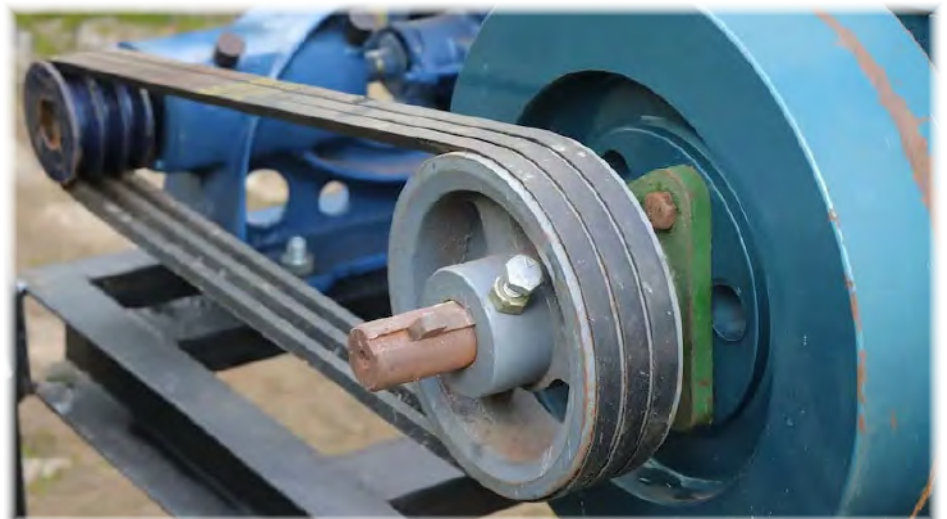

► **CORREIA EM V PERFIL 3V**

► **CORREIA EM V PERFIL 5V**

► **CORREIA EM V PERFIL 8V**



CODIGO	MEDIDA
3367	3V-250
3368	3V-265
3369	3V-280
3370	3V-300
3371	3V-315
3372	3V-325
3373	3V-335
3374	3V-355
3375	3V-375
3376	3V-400
3377	3V-425
3378	3V-450
3379	3V-475
3380	3V-500
3381	3V-530
3382	3V-560
3383	3V-600
3384	3V-630
3385	3V-670
3386	3V-710
3387	3V-730
3388	3V-750
3389	3V-780
3390	3V-800
3391	3V-830
3392	3V-850
3393	3V-900
3394	3V-950
3395	3V-1000
3396	3V-1060
3397	3V-1120
3398	3V-1180
3399	3V-1250
3400	3V-1320
3401	3V-1400
3402	3V-1500

CODIGO	MEDIDA
3403	5V-500
3404	5V-530
3405	5V-560
3406	5V-600
3407	5V-630
3408	5V-670
3409	5V-710
3410	5V-750
3411	5V-800
3412	5V-850
3413	5V-900
3414	5V-950
3415	5V-1000
3416	5V-1060
3417	5V-1120
3418	5V-1180
3419	5V-1250
3420	5V-1320
3421	5V-1400
3422	5V-1500
3423	5V-1600
3424	5V-1700
3425	5V-1800
3426	5V-1900
3427	5V-2000
3428	5V-2120
3429	5V-2240
3430	5V-2360
3431	5V-2500
3432	5V-2650
3433	5V-2800
3434	5V-3000
3435	5V-3150
3436	5V-3350
3437	5V-3550

CODIGO	MEDIDA
3438	8V-1000
3439	8V-1060
3440	8V-1120
3441	8V-1180
3442	8V-1250
3443	8V-1320
3444	8V-1400
3445	8V-1500
3446	8V-1600
3447	8V-1700
3448	8V-1800
3449	8V-1900
3450	8V-2000
3451	8V-2120
3452	8V-2240
3453	8V-2360
3454	8V-2400
3455	8V-2500
3456	8V-2650
3457	8V-2800
3458	8V-3000
3459	8V-3150
3460	8V-3350
3461	8V-3550
3462	8V-4500

► **UNIÃO RETA PLASTICO**



CODIGO	TUBO
3646	04MM
3647	06MM
3648	08MM
3649	10MM
3650	12MM
3651	14MM
3652	16MM
3653	5/32"
3654	3/16"
3655	1/4"
3656	5/16"
3657	3/8"
3658	1/2"

► **UNIÃO EM L PLASTICO**



CODIGO	TUBO
3672	04MM
3673	06MM
3674	08MM
3675	10MM
3676	12MM
3677	14MM
3678	16MM
3679	5/32"
3680	3/16"
3681	1/4"
3682	5/16"
3683	3/8"
3684	1/2"

► **UNIÃO EM Y REDUÇÃO PLASTICO**



CODIGO	TUBO
3698	06MM X 04MM
3699	08MM X 04MM
3700	08MM X 06MM
3701	10MM X 06MM
3702	10MM X 08MM
3703	12MM X 08MM
3704	12MM X 10MM

► **UNIÃO REDUÇÃO PLASTICO**



CODIGO	TUBO
3659	06MM X 04MM
3660	08MM X 04MM
3661	08MM X 06MM
3662	10MM X 06MM
3663	10MM X 08MM
3664	12MM X 08MM
3665	12MM X 10MM
3666	16MM X 12MM
3667	1/4" X 3/16"
3668	5/16" X 1/4"
3669	3/8" X 1/4"
3670	3/8" X 5/16"
3671	1/2" X 3/8"

► **UNIÃO EM Y PLASTICO**



CODIGO	TUBO
3685	04MM
3686	06MM
3687	08MM
3688	10MM
3689	12MM
3690	14MM
3691	16MM
3692	5/32"
3693	3/16"
3694	1/4"
3695	5/16"
3696	3/8"
3697	1/2"

► **UNIÃO EM T PLASTICO**



CODIGO	TUBO
3711	04MM
3712	06MM
3713	08MM
3714	10MM
3715	12MM
3716	14MM
3717	16MM
3718	5/32"
3719	3/16"
3720	1/4"
3721	5/16"
3722	3/8"
3723	1/2"

▶ UNIÃO EM T REDUÇÃO PLASTICO



CODIGO	TUBO
3724	06MM X 04MM
3725	08MM X 04MM
3726	08MM X 06MM
3727	10MM X 06MM
3728	10MM X 08MM
3729	12MM X 08MM
3730	12MM X 10MM
3731	16MM X 12MM

▶ UNIÃO PARA PAINEL



CODIGO	TUBO
3750	04MM
3751	06MM
3752	08MM
3753	10MM
3754	12MM
3755	14MM
3756	16MM
3757	5/32"
3758	3/16"
3759	1/4"
3760	5/16"
3761	3/8"
3762	1/2"

▶ CONEXÃO RETA MACHO



CODIGO	MEDIDA NPT	MEDIDA PARALELA
3763	5MM X 04MM	5MM X 04MM
3764	5MM X 06MM	5MM X 06MM
3765	6MM X 04MM	6MM X 04MM
3766	6MM X 06MM	6MM X 06MM
3767	1/8"NPT X 04MM	3/8" X 04MM
3768	1/8"NPT X 06MM	3/8" X 06MM
3769	1/8"NPT X 08MM	3/8" X 08MM
3770	1/8"NPT X 10MM	3/8" X 10MM
3771	1/4"NPT X 06MM	1/2" X 06MM
3772	1/4"NPT X 04MM	1/2" X 04MM
3773	1/4"NPT X 08MM	1/2" X 08MM
3774	1/4"NPT X 10MM	1/2" X 10MM
3775	1/4"NPT X 1/8"	1/2" X 1/8"
3776	1/4"NPT X 12MM	1/2" X 12MM
3777	3/8"NPT X 04MM	11/16" X 04MM
3778	3/8"NPT X 06MM	11/16" X 06MM
3779	3/8"NPT X 08MM	11/16" X 08MM
3780	3/8"NPT X 10MM	11/16" X 10MM
3781	3/8"NPT X 12MM	11/16" X 12MM
3782	3/8"NPT X 14MM	11/16" X 14MM
3783	3/8"NPT X 16MM	11/16" X 16MM
3784	3/8"NPT X 1/4"	11/16" X 1/4"
3785	1/2"NPT X 06MM	13/16" X 06MM
3786	1/2"NPT X 08MM	13/16" X 08MM
3787	1/2"NPT X 10MM	13/16" X 10MM
3788	1/2"NPT X 12MM	13/16" X 12MM
3789	1/2"NPT X 14MM	13/16" X 14MM
3790	1/2"NPT X 16MM	13/16" X 16MM
3791	1/2"NPT X 1/4"	13/16" X 1/4"

▶ UNIÃO EM X PLASTICO



CODIGO	TUBO
3737	04MM
3738	06MM
3739	08MM
3740	10MM
3741	12MM
3746	1/4"
3747	5/16"
3748	3/8"
3749	1/2"

▶ CONEXÃO RETA FEMEA



CODIGO	MEDIDA NPT	MEDIDA PARALELA
3792	6MM X 04MM	6MM X 04MM
3793	1/8"NPT X 04MM	3/8" X 04MM
3794	1/8"NPT X 06MM	3/8" X 06MM
3795	1/8"NPT X 08MM	3/8" X 08MM
3796	1/8"NPT X 10MM	3/8" X 10MM
3797	1/4"NPT X 04MM	1/2" X 04MM
3798	1/4"NPT X 06MM	1/2" X 06MM
3799	1/4"NPT X 08MM	1/2" X 08MM
3800	1/4"NPT X 10MM	1/2" X 10MM
3801	3/8"NPT X 06MM	11/16" X 06MM

▶ COTOVELO MACHO

CODIGO	MEDIDA NPT	MEDIDA PARALELA
3802	5MM X 04MM	5MM X 04MM
3803	5MM X 06MM	5MM X 06MM
3804	6MM X 04MM	6MM X 04MM
3805	6MM X 06MM	6MM X 06MM
3806	1/8"NPT X 04MM	3/8" X 04MM
3807	1/8"NPT X 06MM	3/8" X 06MM
3808	1/8"NPT X 08MM	3/8" X 08MM
3809	1/8"NPT X 10MM	3/8" X 10MM
3810	1/8"NPT X 3/8"	3/8" X 3/8"
3811	1/4"NPT X 04MM	1/2" X 04MM
3812	1/4"NPT X 06MM	1/2" X 06MM
3813	1/4"NPT X 08MM	1/2" X 08MM
3814	1/4"NPT X 10MM	1/2" X 10MM
3815	1/4"NPT X 12MM	1/2" X 12MM
3816	1/4"NPT X 1/4"	1/2" X 1/4"
3817	3/8"NPT X 04MM	11/16" X 04MM
3818	3/8"NPT X 06MM	11/16" X 06MM
3819	3/8"NPT X 08MM	11/16" X 08MM
3820	3/8"NPT X 10MM	11/16" X 10MM
3821	3/8"NPT X 12MM	11/16" X 12MM
3822	3/8"NPT X 14MM	11/16" X 14MM
3823	3/8"NPT X 16MM	11/16" X 16MM
3824	1/2"NPT X 06MM	13/16" X 06MM
3825	1/2"NPT X 08MM	13/16" X 08MM
3826	1/2"NPT X 10MM	13/16" X 10MM
3827	1/2"NPT X 12MM	13/16" X 12MM
3828	1/2"NPT X 14MM	13/16" X 14MM
3829	1/2"NPT X 16MM	13/16" X 16MM

▶ COTOVELO FEMEA

CODIGO	MEDIDA NPT	MEDIDA PARALELA
3830	5MM X 04MM	5MM X 04MM
3831	5MM X 06MM	5MM X 06MM
3832	1/8"NPT X 04MM	3/8" X 04MM
3833	1/8"NPT X 06MM	3/8" X 06MM
3834	1/8"NPT X 08MM	3/8" X 08MM
3835	1/8"NPT X 10MM	3/8" X 10MM
3836	1/4"NPT X 04MM	1/2" X 04MM
3837	1/4"NPT X 06MM	1/2" X 06MM
3838	1/4"NPT X 08MM	1/2" X 08MM
3839	1/4"NPT X 10MM	1/2" X 10MM
3840	1/4"NPT X 12MM	1/2" X 12MM
3841	3/8"NPT X 04MM	11/16" X 04MM
3842	3/8"NPT X 06MM	11/16" X 06MM
3843	3/8"NPT X 08MM	11/16" X 08MM
3844	3/8"NPT X 10MM	11/16" X 10MM
3845	3/8"NPT X 12MM	11/16" X 12MM
3846	1/2"NPT X 06MM	13/16" X 06MM
3847	1/2"NPT X 08MM	13/16" X 08MM
3848	1/2"NPT X 10MM	13/16" X 10MM
3849	1/2"NPT X 12MM	13/16" X 12MM

▶ UNIÃO T MACHO CENTRAL

CODIGO	MEDIDA NPT	MEDIDA PARALELA
3850	5MM X 04MM	5MMX04MM
3851	5MM X 06MM	5MMX06MM
3852	6MM X 04MM	6MMX04MM
3853	6MM X 06MM	6MMX06MM
3854	1/8"NPT X 04MM	3/8" X 04MM
3855	1/8"NPT X 06MM	3/8" X 06MM
3856	1/8"NPT X 08MM	3/8" X 08MM
3857	1/8"NPT X 10MM	3/8" X 10MM
3858	1/4"NPT X 04MM	1/2" X 04MM
3859	1/4"NPT X 06MM	1/2" X 06MM
3860	1/4"NPT X 08MM	1/2" X 08MM
3861	1/4"NPT X 10MM	1/2" X 10MM
3862	1/4"NPT X 12MM	1/2" X 12MM
3863	3/8"NPT X 04MM	11/16" X 04MM
3864	3/8"NPT X 06MM	11/16" X 06MM
3865	3/8"NPT X 08MM	11/16" X 08MM
3866	3/8"NPT X 10MM	11/16" X 10MM
3867	3/8"NPT X 12MM	11/16" X 12MM
3868	3/8"NPT X 16MM	11/16" X 16MM
3869	1/2"NPT X 06MM	13/16" X06MM
3870	1/2"NPT X 08MM	13/16" X 08MM
3871	1/2"NPT X 10MM	13/16" X 10MM
3872	1/2"NPT X 12MM	13/16" X 12MM
3873	1/2"NPT X16MM	13/16" X 16MM



► UNIÃO T MACHO LATERAL



► UNIÃO Y MACHO



► REGULADOR DE FLUXO



CODIGO	MEDIDA NPT	MEDIDA PARALELA
3874	5MM X 04MM	5MMX04MM
3875	5MM X 06MM	5MMX06MM
3876	6MM X 04MM	6MMX04MM
3877	6MM X 06MM	6MMX06MM
3878	1/8"NPT X 04MM	3/8" X 04MM
3879	1/8"NPT X 06MM	3/8" X 06MM
3880	1/8"NPT X 08MM	3/8" X 08MM
3881	1/8"NPT X 10MM	3/8" X 10MM
3882	1/4"NPT X 04MM	1/2" X 04MM
3883	1/4"NPT X 06MM	1/2" X 06MM
3884	1/4"NPT X 08MM	1/2" X 08MM
3885	1/4"NPT X 10MM	1/2" X 10MM
3886	1/4"NPT X 12MM	1/2" X 12MM
3887	3/8"NPT X 04MM	11/16" X 04MM
3888	3/8"NPT X 06MM	11/16" X 06MM
3889	3/8"NPT X 08MM	11/16" X 08MM
3890	3/8"NPT X 10MM	11/16" X 10MM
3891	3/8"NPT X 12MM	11/16" X 12MM
3892	3/8"NPT X 16MM	11/16" X 16MM
3893	1/2"NPT X 06MM	13/16" X 06MM
3894	1/2"NPT X 08MM	13/16" X 08MM
3895	1/2"NPT X 10MM	13/16" X 10MM
3896	1/2"NPT X 12MM	13/16" X 12MM
3897	1/2"NPT X 16MM	13/16" X 16MM

CODIGO	MEDIDA NPT	MEDIDA PARALELA
3898	5MM X 04MM	5MMX04MM
3899	5MM X 06MM	5MMX06MM
3900	6MM X 04MM	6MMX04MM
3901	6MM X 06MM	6MMX06MM
3902	1/8"NPT X 04MM	3/8" X 04MM
3903	1/8"NPT X 06MM	3/8" X 06MM
3904	1/8"NPT X 08MM	3/8" X 08MM
3905	1/8"NPT X 10MM	3/8" X 10MM
3906	1/4"NPT X 04MM	1/2" X 04MM
3907	1/4"NPT X 06MM	1/2" X 06MM
3908	1/4"NPT X 08MM	1/2" X 08MM
3909	1/4"NPT X 10MM	1/2" X 10MM
3910	1/4"NPT X 12MM	1/2" X 12MM
3911	3/8"NPT X 04MM	11/16" X 04MM
3912	3/8"NPT X 06MM	11/16" X 06MM
3913	3/8"NPT X 08MM	11/16" X 08MM
3914	3/8"NPT X 10MM	11/16" X 10MM
3915	3/8"NPT X 12MM	11/16" X 12MM
3917	1/2"NPT X 06MM	13/16" X 06MM
3918	1/2"NPT X 08MM	13/16" X 08MM
3919	1/2"NPT X 10MM	13/16" X 10MM
3920	1/2"NPT X 12MM	13/16" X 12MM

CODIGO	MEDIDA NPT	MEDIDA PARALELA
3922	5MM X 04MM	5MMX04MM
3923	5MM X 06MM	5MMX06MM
3924	1/8"NPT X 04MM	3/8" X 04MM
3925	1/8"NPT X 06MM	3/8" X 06MM
3926	1/8"NPT X 08MM	3/8" X 08MM
3927	1/8"NPT X 10MM	3/8" X 10MM
3928	1/4"NPT X 04MM	1/2" X 04MM
3929	1/4"NPT X 06MM	1/2" X 06MM
3930	1/4"NPT X 08MM	1/2" X 08MM
3931	1/4"NPT X 10MM	1/2" X 10MM
3932	1/4"NPT X 12MM	1/2" X 12MM
3933	3/8"NPT X 06MM	11/16" X 06MM
3934	3/8"NPT X 08MM	11/16" X 08MM
3935	3/8"NPT X 10MM	11/16" X 10MM
3936	3/8"NPT X 12MM	11/16" X 12MM
3937	1/2"NPT X 06MM	13/16" X 06MM
3938	1/2"NPT X 08MM	13/16" X 08MM
3939	1/2"NPT X 10MM	13/16" X 10MM
3940	1/2"NPT X 12MM	13/16" X 12MM



► **UNIÃO RETA METALICA**



CODIGO	TUBO
3941	04MM
3942	06MM
3943	08MM
3944	10MM
3945	12MM
3950	1/4"
3951	5/16"
3952	3/8"
3953	1/2"

► **UNIÃO EM L METALICA**



CODIGO	TUBO
3954	04MM
3955	06MM
3956	08MM
3957	10MM
3958	12MM
3963	1/4"
3964	5/16"
3965	3/8"
3966	1/2"

► **UNIÃO EM T METALICA**



CODIGO	TUBO
3967	04MM
3968	06MM
3969	08MM
3970	10MM
3971	12MM
3976	1/4"
3977	5/16"
3978	3/8"
3979	1/2"

► **UNIÃO RETA INSTANTANEA METALICA**



CODIGO	TUBO
3980	04MM
3981	06MM
3982	08MM
3983	10MM
3984	12MM
3985	14MM
3986	16MM
3987	5/32"
3988	3/16"
3989	1/4"
3990	5/16"
3991	3/8"
3992	1/2"

► **CONECTOR MACHO COM ORING**



CODIGO	TUBO	ROSCA
4073	8MM	12X1,5MM
4074	10MM	12X1,5MM
4075	12MM	12X1,5MM
4076	8MM	14X1,5MM
4077	10MM	14X1,5MM
4078	12MM	14X1,5MM
4079	8MM	14X1,5MM
4080	10MM	16X1,5MM
4081	12MM	16X1,5MM
4082	22MM	16X1,5MM

► **COTOVELO MACHO COM ORING**



CODIGO	TUBO	ROSCA
4083	6MM	12X1,5MM
4084	8MM	12X1,5MM
4085	10MM	12X1,5MM
4086	12MM	12X1,5MM
4087	8MM	14X1,5MM
4088	10MM	14X1,5MM
4089	12MM	14X1,5MM
4090	8MM	16X1,5MM
4091	10MM	16X1,5MM
4092	12MM	16X1,5MM

► **CONJUNTO UNIÃO PARA TUBO**



CODIGO	TUBO
3993	4MM
3994	6MM
3995	8MM
3996	10MM
3997	12MM
3998	14MM
3999	16MM
4000	3/16"
4001	1/4"
4002	5/16"
4003	3/8"
4004	1/2"
4005	5/8"

► **CONJUNTO UNIÃO EM L PARA TUBO**



CODIGO	TUBO
4006	4MM
4007	6MM
4008	8MM
4009	10MM
4010	12MM
4011	14MM
4012	16MM
4013	3/16"
4014	1/4"
4015	5/16"
4016	3/8"
4017	1/2"
4018	5/8"

► **CONJUNTO UNIÃO EM T PARA TUBO**



CODIGO	TUBO
4019	4MM
4020	6MM
4021	8MM
4022	10MM
4023	12MM
4024	14MM
4025	16MM
4026	3/16"
4027	1/4"
4028	5/16"
4029	3/8"
4030	1/2"
4031	5/8"

► **LUVA (ANILHA) PARA TUBO DE COMPRESSAO**



CODIGO	TUBO
4041	1/8"
4042	3/16"
4043	1/4"
4044	5/16"
4045	3/8"
4046	7/16"
4047	1/2"
4048	5/8"

► **LUVA (ANILHA) PARA TUBO FREIO A AR**



CODIGO	TUBO
4032	4MM
4033	6MM
4034	8MM
4035	10MM
4036	12MM
4037	14MM
4038	16MM
4039	18MM
4040	22MM

► **INSERTO PARA TUBO**



CODIGO	TUBO
4061	4MM
4062	6MM
4063	8MM
4064	10MM
4065	12MM
4066	14MM
4067	16MM
4068	1/4"
4069	5/16"
4070	3/8"
4071	1/2"
4072	5/8"



▶ **PORCA CURTA PARA TUBO**



CODIGO	TUBO
4049	4,0MM
4050	6,0MM
4051	8,0MM
4052	10,0MM
4053	12,0MM
4054	14,0MM
4055	16,0 MM
4056	1/4"
4057	5/16"
4058	3/8"
4059	1/2"
4060	5/8"

▶ **BUJÃO COM ANEL ORING**



CODIGO	MEDIDA	CHAVE
4112	M12X1,5	16MM
4113	M14X1,5	16MM
4114	M16X1,5	19MM
4115	M18X1,5	7/8"
4116	M22X1,5	1"

▶ **REDUCAO MACHO X FEMEA**



CODIGO	MACHO	FEMEA
4105	16MMX1,5	12MMX1,5
4106	16MMX1,5	1/4" NPT
4110	16MMX1,5	1/2" NPT
4109	22MMX1,5	16MMX1,5
4107	22MMX1,5	1/4" NPT
4108	22MMX1,5	3/8" NPT
4111	26MMX1,5	1/2" NPT

▶ **UNIÃO PARA MANGUEIRA**



CODIGO	TUBO
4093	6MM
4094	8MM
4095	10MM
4096	12MM
4097	1/4"
4098	5/16"
4099	3/8"
4100	1/2"

▶ **BICO COM ESCAMA PARA MANGUEIRA**



CODIGO	TUBO	ROSCA
4117	1/4"	1/8" NPT
4118	1/4"	1/4" NPT
4119	1/4"	1/2" NPT
4122	5/16"	1/8" NPT
4123	5/16"	1/4" NPT
4124	5/16"	3/8" NPT
4120	3/8"	1/4" NPT
4121	1/2"	1/2" NPT

▶ **PORCA ENGATE RAPIDO**



• Para uso em sistema de rodoar.
• Engate rapido cod: 9189

CODIGO	MEDIDA	TUBO
9190	7/16"	8,00 X 1,25MM

▶ **UNIÃO T PARA MANGUEIRA**



CODIGO	TUBO
4101	1/4"
4102	5/16"
4103	3/8"
4104	1/2"

▶ **CONECTOR COM ESCAMA PARA MANGUEIRA**



CODIGO	TUBO	ENGATE
4125	1/4"	1/4"
4126	5/16"	1/4"
4127	3/8"	1/4"
4128	1/2"	1/4"

▶ **ENGATE RAPIDO 1/4 ROSCA FEMEA**



▶ **ENGATE RAPIDO 1/4 ROSCA FEMEA CAPA PLASTICA**



▶ **ENGATE RAPIDO 1/4 ROSCA MACHO**



CODIGO	ROSCA
9183	1/4 NPTF

CODIGO	ROSCA
9184	1/4 NPTF

CODIGO	ROSCA
9185	1/4 NPTF

▶ **ENGATE RAPIDO 1/4 COM ESCAMA**



▶ **ENGATE RAPIDO 1/4 COM ROSCA 7/16 UNF P/ TUBO PU 8,00 X 1,25MM**



- Para uso em sistema de rodobar.
- Porca cod: 9190

▶ **CONECTOR 1/4 ROSCA MACHO PARA ENGATE RAPIDO**



CODIGO	ESCAMA
9186	TUBO 3/8"

CODIGO	ROSCA
9189	7/16 UNF

CODIGO	ROSCA
9187	1/4 NPTF

▶ **CONECTOR 1/4 ROSCA FEMEA PARA ENGATE RAPIDO**



▶ **CONJUTO ENGATE RAPIDO 1/2 ROSCA FEMEA COM TRAVA**



▶ **CONJUTO ENGATE RAPIDO 1/2 ROSCA FEMEA COM TRAVA**



CODIGO	ROSCA
9188	1/4 NPTF

CODIGO	ROSCA
9191	1/2 NPTF

CODIGO	ROSCA
9192	M-16X1,5

▶ **CONJUTO ENGATE RAPIDO HIDRAULICO 1/2 ROSCA FEMEA PUSH/PULL**



CODIGO	MEDIDA
9193	1/2"

▶ **CONJUTO ENGATE RAPIDO HIDRAULICO**



CODIGO	MEDIDA
9194	3/4"
9195	1"
9196	1" ROSCA 3/4" NPT (BASCULANTE)

▶ **PROTETOR PARA ENGATE RAPIDO MACHO**



CODIGO	MEDIDA
9197	1/2"
9198	3/4"
9199	1"

▶ **PROTETOR PARA ENGATE RAPIDO FEMEA**



CODIGO	MEDIDA
9200	1/2"
9201	3/4"
9202	1"



▶ TUBO DE NYLON SEM TRAMA



• APLICAÇÕES
É recomendado para uso em sistemas de freio a ar de caminhões / ônibus e outros veículos pesados. Linhas de combustíveis, ar comprimido para instrumentação pneumática.

• TEMPERATURA DE TRABALHO -40° à 93° C •

• Dados Técnicos
Pressão de trabalho: Até 100 PSI.
Aplicação: Agroindustrial, Industrial, Automobilístico (caminhões, ônibus, tratores), Automação, Pneumática e etc.

CODIGO	EXTERNO	INTERNO	ESPESS. PAREDE
4129	6,00	4,00	1,00
4130	8,00	4,00	2,00
4131	10,00	7,00	1,50
4132	10,00	8,00	1,00
4133	11,00	8,00	1,50
4134	12,00	9,00	1,50
4135	13,00	10,00	1,50
4136	14,00	10,00	2,00
4137	14,00	11,00	1,50
4138	15,00	12,00	1,50
4139	16,00	12,00	2,00
4140	18,00	14,00	2,00
4141	1/8" (3,17)	1/16" (1,58)	0,80
4142	3/16" (4,76)	1/8" (3,17)	0,79
4143	1/4" (6,35)	11/64" (4,36)	1,00
4144	5/16" (7,93)	15/64" (5,95)	1,00
4145	3/8" (9,53)	1/4" (6,35)	1,59
4146	1/2" (12,70)	3/8" (9,53)	1,59
4147	5/8" (15,88)	7/16" (11,20)	2,34

▶ TUBO DE NYLON COM TRAMA



CODIGO	EXTERNO	INTERNO	ESPESS. PAREDE
4148	10.00	7.00	1.50
4149	12.00	9.00	1.50
4150	16.00	12.00	2.00
4151	3/8" (9.53)	1/4" (6.35)	1.59
4152	1/2" (12.70)	3/8" (9.53)	1.59
4153	5/8" (15.88)	7/16" (11.20)	2.34

▶ CORTADOR DE TUBO



CODIGO	MEDIDAS DE TUBO
4162	TODAS

▶ TUBO POLIURETANO (PU) AZUL



• APLICAÇÕES
Utilizado em sistemas pneumáticos, painéis de distribuição, dosadores, indústria automotiva, sistemas robotizados, sistemas de lubrificação e ferramentas pneumáticas.
Outras cores sob consulta

• Dados Técnicos
Pressão de trabalho: Até 100 PSI.
Aplicação: Agroindustrial, Industrial, Automobilístico (caminhões, ônibus, tratores), Automação, Pneumática e etc.

CODIGO	EXTERNO	INTERNO	ESPESS. PAREDE
4154	4.00	2.00	1.00
4155	6.00	4.00	1.00
4156	8.00	5.50	1.25
4157	8.00	6.00	1.00
4158	10.00	7.00	1.50
4159	12.00	8.00	2.00
4160	14.00	10.00	2.00
4161	16.00	12.00	2.50



 <p>9462 VÁLVULA TR-412 P/ PNEU S/ CÂMARA DE MOTO CURTA</p>	 <p>9463 VÁLVULA PVR-70 CURVA 90 GRAU P/ PNEU S/ CÂMARA SCOOTER</p>	 <p>9464 VÁLVULA TR-413 P/ PNEU S/ CÂMARA</p>	 <p>9465 VÁLVULA TR-414 P/ PNEU S/ CÂMARA</p>
 <p>9466 VÁLVULA TR-415 P/ PNEU S/ CÂMARA FUSCA/ KOMBI</p>	 <p>9467 VÁLVULA TR-418 P/ PNEU S/ CÂMARA</p>	 <p>9468 VÁLVULA P/ SENSOR TORO 16/... RENEGADE/ COMPASS 15/...</p>	 <p>9469 VÁLVULA P/ PNEU S/ CÂMARA BASE SEXTAVADA P/ CAMINHÕES E ONIBUS RODA DE FERRO</p>
 <p>9470 VÁLVULA P/ PNEU S/ CÂMARA AR/AGUA VEICULOS AGRICOLA</p>	 <p>10682 VÁLVULA TR-218A P/ PNEU C/ CÂMARA AR/ AGUA VEICULOS AGRICOLA</p>	 <p>9471 NUCLEO PARA VÁLVULA DE PNEU</p>	 <p>9472 TAMPA PRETA P/ VALVULA DE PNEU</p>

► **BICO INFLADOR DUPLO 150MM 1/4 NPT**



CODIGO	MEDIDA
9473	150MM

► **CALIBRADOR MANUAL AR/ AGUA 05 A 50 LIBRAS PARA VEICULOS LEVES E LINHA AGRICOLA**



CODIGO	LIBRAS
9474	05 A 50

► **CALIBRADOR MANUAL AR 10 A 160 LIBRAS PARA CAMINHÕES**



CODIGO	LIBRAS
9475	10 A 160

▶ CALIBRADOR DE PNEUS COM MANOMETRO



- Mangueira Flexível
- Bico prendedor para fácil operação
- Válvula de alívio de pressão
- Manômetro para monitoramento de pressão
- Rosca de 1/4" NPT
- Pressão de trabalho 7 BAR (100 PSI)

CODIGO

9309

ROSCA

1/4" NPT

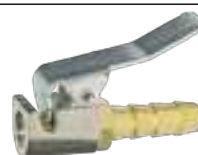

9527

BICO C/ PRESILHA P/ MANGUEIRA 1/4"
(ESCAMA 22MM) SEM RETENCAO DE AR



9476

SACA NUCLEO DE VALVULA 4 FUNCOES



9477

SACA NUCLEO LONGO 140MM



9478

CHAVE SACA NUCLEO COM CABO 100MM



9479

FERRAMENTA P/ SACAR VÁLVULA SEM
CÂMARA



9480

KIT REPARO PARA REMENDO DE PNEUS



9481

REFIL P/ PNEU S/ CÂMARA (CX 60 UNID.)
MACARRAO IMPORTADO



9482

REPARO CAMARA DE AR A FRIO 40MM BLACK
V-1 (CX C/ 100)



9483

REPARO CAMARA DE AR A FRIO 50MM BLACK
V-2 (CX C/ 40)



9484

REPARO CAMARA DE AR A FRIO 60MM BLACK
V-3 (CX C/ 40)



9485

REPARO P/ REMENDO PNEU A FRIO
50X50MM VFP-6 BLACK (CX C/ 100)



9486

CIMENTO VULCANITE P/ REPARO CAMARA DE
AR A FRIO BISNAGA 18G



9487

CIMENTO VULCANITE P/ REPARO CÂMARA DE
AR A FRIO FV-0 163G



9488

GIZ CERA AMARELO P/ DEMARCAÇÃO PNEU
(CX C/ 12)



9489

VULCANITE P/ REMENDO CAMARA DE AR A
QUENTE 1KG



9490

COLAFLEX P/ VULCANITE QUENTE 690G



9491

PASTA PARA MONTAGEM PNEUS 3KG



9492

VASELINA SOLIDA PARA MONTAGEM PNEUS
3 KG

▶ MANDRIL COM CHAVE



CODIGO	MEDIDA
10497	3/8 (1,5-13MM) C/ CHAVE
10498	1/2 (1,5-13MM) C/ CHAVE
9307	CONE B16 (3,0-16MM) C/ CHAVE
9308	CONE B18 (3,0-16MM) C/ CHAVE

▶ CHAVE PARA MANDRIL



CODIGO	MEDIDA
10501	10MM
10502	13MM

▶ MANDRIL APERTO RAPIDO



• Não utiliza chave.

CODIGO	MEDIDA
10499	1/2 (1-10MM)

▶ MANDRIL AUTO LOCK



• APERTO RÁPIDO
• Função Auto Lock (trava de segurança para evitar o destravamento da broca)

CODIGO	MEDIDA
10500	1/2 (2-13MM)

▶ BROCA VIDEA PARA CONCRETA



CODIGO	MEDIDA
10458	4MM
10459	5MM
10460	6MM
10461	8MM
10462	10MM
10463	12MM

▶ BROCA VIDEA PARA CONCRETA LONGA



CODIGO	MEDIDA
9454	4MM X 300MM
9455	5MM X 300MM
9456	6MM X 300MM
9457	8MM X 300MM
9458	10MM X 300MM
9459	12MM X 300MM



► BROCA AÇO RADIPO MILIMETRO



- Polida
- Para metais ferrosos e não ferrosos
- Haste cilíndrica
- Ângulo de afiação da ponta de 118°
- Norma DIN 338
- Para aumento da vida útil do produto é recomendado a utilização de fluido.

CODIGO	MEDIDA
10417	1MM
10418	1,5MM
10419	2MM
10420	2,5MM
10421	3MM
10422	3,5MM
10423	4MM
10424	4,5MM
10425	5MM
10426	5,5MM
10427	6MM
10428	6,5MM
10429	7MM
10430	7,5MM
10431	8MM
10432	8,5MM
10433	9MM
10434	9,5MM
10435	10MM
10436	11MM
10437	12MM
10438	13MM
10439	14MM
10440	15MM
10441	16MM
10442	17MM
10443	18MM
10444	19MM
10445	20MM



► BROCA AÇO RADIPO POLEGADA



- Polida
- Para metais ferrosos e não ferrosos
- Haste cilíndrica
- Ângulo de afiação da ponta de 118°
- Norma DIN 338
- Para aumento da vida útil do produto é recomendado a utilização de fluido.

CODIGO	MEDIDA
9295	1/16"
9294	5/64"
10446	3/32"
10447	7/64"
10448	1/8"
10449	9/64"
10450	5/32"
9293	11/64"
10451	3/16"
9292	13/64"
10452	7/32"
10453	1/4"
10454	5/16"
10455	3/8"
10456	7/16"
10457	1/2"

► BROCA ESCALONADA HSS NITRETO DE TITÂNIO



- Haste sextavada
- Alta precisão de furação

CODIGO	MEDIDA
9303	4-5-6-7-8-9-10-11-12MM
9304	4-6-8-10-12-14-16-18-20MM
9305	6-8-10-12-14-16-18-20-22-24-26-28-30MM
9306	9-12-15-18-21-24-27-30-33-36MM

► BROCA AÇO RADIPO TITÂNIO



- Polida/Nitreto de Titânio
- Para metais ferrosos e não ferrosos
- Haste cilíndrica
- Ângulo de afiação da ponta de 118°
- Norma DIN 338
- Corpo de aço rápido (HSS)

CODIGO	MEDIDA
10464	2MM
10465	2,5MM
10466	3MM
10467	3,5MM
10468	4MM
10469	4,5MM
10470	5MM
10471	5,5MM
10472	6MM
10473	6,5MM
10474	7MM
10475	7,5MM
10476	8MM
10477	8,5MM
10478	9MM
10479	9,5MM
10480	10MM
10481	11MM
10482	12MM

► BROCA CHATA PARA MADEIRA



- Para madeira, MDF, MDP, compensado plástico
- Indicada para lâminas/chapas finas
- Possui ponta com afiação que facilita a centralização do furo.

CODIGO	MEDIDA
10483	6MM
10484	8MM
10485	10MM
10486	12MM
10487	14MM
10488	16MM
10489	18MM
10490	22MM
10491	24MM
10492	25MM
10493	32MM
10494	38MM
10495	45MM
10496	50MM

► BROCA PARA CONCRETA SDS PLUS



- Encaixe SDS Plus
- Espiral dupla reforçada
- Acabamento jateado
- Norma DIN 8039
- Proteção plástica total na broca
- Têmpera total no corpo
- Ponta de carboneto de tungstênio (metal duro)

CODIGO	MEDIDA
9280	4,0MM X 110 MM
9281	5,0MM X 110 MM
9282	5,5MM X 110 MM
9283	6,0MM X 110 MM
9284	6,5MM X 110 MM
9285	7,0MM X 110 MM
9286	8,0 X 110 MM
9287	8,0 X 260 MM
9288	10,0 X 260 MM
9289	12,0 X 260 MM
9290	14,0 X 260 MM
9291	16,0 X 260 MM



▶ JOGO DE MACHO AÇO LIGA ROSCA GROSSA



CODIGO	MEDIDA
10539	HSS MA M5 X 0,80 3PC
10540	HSS MA M6 X 1,00 3PC
10541	HSS MA M7 X 1,00 3PC
10542	HSS MA M8 X 1,25 3PC
10543	HSS MA M10 X 1,50 3PC
10544	HSS MA M12 X 1,75 3PC
10545	HSS MA M14 X 2,00 3PC
10546	HSS MA M16 X 2,00 3PC
10547	HSS MA M18 X 2,50 3PC
10548	HSS MA M20 X 2,50 3PC
10562	HSS UNC 3/16 X 24 FIOS 3PC
10563	HSS UNC 1/4 X 20 FIOS 3PC
10564	HSS UNC 5/16 X 18 FIOS 3PC
10565	HSS UNC 3/8 X 16 FIOS 3PC
10566	HSS UNC 7/16 X 14 FIOS 3PC
10567	HSS UNC 1/2 X 13 FIOS 3PC
10568	HSS UNC 9/16 X 12 FIOS 3PC
10569	HSS UNC 5/8 X 11 FIOS 3PC
10570	HSS UNC 3/4 X 10 FIOS 3PC
10571	HSS UNC 7/8 X 9 FIOS 3PC
10572	HSS UNC 1 X 8 FIOS 3PC

▶ JOGO DE MACHO AÇO LIGA ROSCA FINA



CODIGO	MEDIDA
10549	HSS MB M6 X 0,75 2PC
10550	HSS MB M8 X 1,00 2PC
10551	HSS MB M10 X 1,00 2PC
10552	HSS MB M10 X 1,25 2PC
10553	HSS MB M12 X 1,25 2PC
10554	HSS MB M12 X 1,50 2PC
10555	HSS MB M13 X 1,50 2PC
10556	HSS MB M14 X 1,25 2PC
10557	HSS MB M14 X 1,50 2PC
10558	HSS MB M15 X 1,50 2PC
10559	HSS MB M16 X 1,50 2PC
10560	HSS MB M18 X 1,50 2PC
10561	HSS MB M20 X 1,50 2PC
10573	HSS UNF 3/16 X 32 FIOS 2PC
10574	HSS UNF 1/4 X 28 FIOS 2PC
10575	HSS UNF 5/16 X 24 FIOS 2PC
10576	HSS UNF 3/8 X 24 FIOS 2PC
10577	HSS UNF 7/16 X 20 FIOS 2PC
10578	HSS UNF 1/2 X 20 FIOS 2PC
10579	HSS UNF 9/16 X 18 FIOS 2PC
10580	HSS UNF 5/8 X 18 FIOS 2PC
10581	HSS UNF 3/4 X 16 FIOS 2PC
10582	HSS UNF 7/8 X 14 FIOS 2PC
10583	HSS UNF 1 X 12 FIOS 2PC

▶ VIRA MACHO TIPO T



CODIGO	MEDIDA
10584	M3 A M12
10585	M6 A M20

▶ VIRA MACHO COM CATRACA



CODIGO	MEDIDA
10586	M3 A M8
10587	A M12

▶ ALICATE UNIVERSAL

- Linha Nickel
- Acabamento polido
- Cabo Plástico anatômico com dois componentes

CODIGO	MEDIDA
10389	8"

▶ ALICATE CORTE DIAGONAL

- Linha Nickel
- Lâmina de corte temperada
- Acabamento polido

CODIGO	MEDIDA
10391	6.1/2"

▶ ALICATE BICO RETO

- Linha Nickel
- Acabamento polido

CODIGO	MEDIDA
10393	6.1/2"

▶ ALICATE BICO RETO CURVO

- Linha Nickel
- Acabamento polido

CODIGO	MEDIDA
10394	6.1/2"

▶ ALICATE P/ ANEIS EXTERNO PONTA RETA

- Para anéis de retenção externos (furos)
- Acabamento fosfatizado
- Uso industrial

CODIGO	MEDIDA
9318	6"- 150MM

▶ ALICATE P/ ANEIS EXTERNO PONTA CURVA

- Para anéis de retenção externos (furos)
- Acabamento fosfatizado
- Uso industrial

CODIGO	MEDIDA
9320	6"- 150MM

▶ ALICATE P/ ANEIS INTERNO PONTA RETA

- Para anéis de retenção internos (furos)
- Acabamento fosfatizado
- Uso industrial

CODIGO	MEDIDA
9319	6"- 150MM

▶ ALICATE P/ ANEIS INTERNO PONTA CURVA

- Para anéis de retenção internos (furos)
- Acabamento fosfatizado
- Uso industrial

CODIGO	MEDIDA
9321	6"- 150MM

▶ JOGO CHAVE ALLEN ACETINADO 9 PEÇAS



CODIGO

9322

COMPOSIÇÃO

2; 2,5; 3; 4; 5; 6; 8; 10; 12MM;

▶ JOGO CHAVE ALLEN ACETINADO LONGO 9 PEÇAS



CODIGO

9336

COMPOSIÇÃO

2; 2,5; 3; 4; 5; 6; 8; 10; 12MM;

▶ JOGO CHAVE TORX ACETINADO 9 PEÇAS



CODIGO

9337

COMPOSIÇÃO

T10; T15; T20; T25; T27; T30; T40; T45; T50;

▶ JOGO CHAVE TORX ACETINADO LONGO 9 PEÇAS



CODIGO

9338

COMPOSIÇÃO

T10; T15; T20; T25; T27; T30; T40; T45; T50;

▶ PAQUIMETRO DE METAL



- Paquímetro analógico, fabricado em aço;
- Utilizado para medir com precisão as dimensões de pequenos objetos
- Acompanha estojo de plástico para armazenamento do produto.
- Graduação: 1/128" - 0,05 mm
- Exatidão do instrumento: aprox. 0,08 mm
- Capacidade de medição: 0 - 150 mm (6")

CODIGO

9296

MEDIDA

6" 150MM - 0,05MM

▶ PAQUIMETRO DIGITAL DE METAL



- Faixa de medição: (de 0" a 6") 0 a 150mm
- Divisão de escala: +/- 0,01mm / 0,0005 - 1/64"
- Bateria 2x 1,5V - Sr44
- Medição fácil e com precisão
- Indicado para medições internas e externas
- Embalagem: caixa plástica

CODIGO

9297

MEDIDA

6" 150MM - 0,0005MM

▶ ESTILETE PROFISSIONAL



- Possui 1 lâmina de alta qualidade
- Empunhadura de plástico e cabo anatômico
- Plástico reforçado
- Alta durabilidade para uso profissional e doméstico
- Possui trava da lâmina e dispositivo para substituir a lâmina com segurança

CODIGO

9498

MEDIDA

18MM

▶ LÂMINA PARA ESTILETE CAIXA COM 10 PEÇAS



CODIGO

9499

MEDIDA

18MM

▶ ARCO DE SERRA



- Cabo e suporte frontal em alumínio moldado
- Ajustável a 10" ou 12"

CODIGO	MEDIDA
10413	12"

▶ JOGO LAMINAS DE SERRA BI-METAL 12" 2 PEÇAS



- Para arco de serra

CODIGO	MEDIDA
10588	18 TPI 12 (300MM)
10589	24 TPI 12 (300MM)

▶ JOGO DE LÂMINAS AÇO RÁPIDO BI-METAL P/ SERRA TICO TICO 3 PEÇAS



- Aço rápido bimetal
- Encaixe para maquinário Bosch, AEG, Makita, Dewalt, Metabo
- Indicada para trabalhos com metais ferrosos e não ferrosos madeira maciça, compensados, MDF e plástico.

CODIGO	MEDIDA
9344	75 x 1,2MM BI-METAL

▶ JOGO DE LÂMINAS P/ SERRA TICO TICO 3 PEÇAS



- Aço Carbono
- Encaixe para maquinário Bosch, AEG, Makita, Dewalt, Metabo
- Indicada para trabalhos com madeira maciça, compensados e plástico.

CODIGO	MEDIDA
9345	75 x 2,5MM

▶ JOGO DE LÂMINAS P/ SERRA TICO TICO 5 PEÇAS

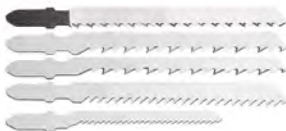

- Aço Carbono
- Encaixe para maquinário Bosch, AEG, Makita, Dewalt, Metabo
- Indicada para trabalhos com metais ferrosos e não ferrosos madeira maciça, compensados, MDF e plástico.

CODIGO	COMPOSIÇÃO
9343	T-SET3 (T101BR, T111C, T144D, T244D, T119B0)

▶ JOGO DE FORMÕES CABO PLÁSTICO COM BORRACHA 4 PEÇAS



- Lâmina de aço especial de alta resistência para absorção de impactos
- Cabo anatômico de plástico com borracha termoplástica

CODIGO	COMPOSIÇÃO
9340	1/4"; 1/2"; 23/32"; 15/16";

▶ JOGO DE LIMAS MURÇA 3 PEÇAS



- Murça
- Cabo plástico

CODIGO	MEDIDA
9342	8" - 200MM

▶ JOGO DE LIMAS MURÇA 5 PEÇAS



- Murça
- Cabo plástico

CODIGO	MEDIDA
9341	8" - 200MM

▶ JOGO DE BITS 1/4 SOQUETE SEXTAVADO MAGNÉTICO 2 PEÇAS



- Encaixe 1/4"
- Embalagem com 2 peças

CODIGO	MEDIDA
10525	6MM X 45MM
10526	7MM X 45MM
10527	8MM X 45MM
10528	10MM X 45MM
10529	12MM X 45MM
10530	13MM X 45MM
9347	8MM X 65MM
9348	10MM X 65MM
9349	13MM X 65MM

▶ BITS 1/4 SOQUETE SEXTAVADO MAGNÉTICO



- Encaixe 1/4"

CODIGO	MEDIDA
10531	1/4 X 65MM
10532	5/16 X 65MM
10533	1/2 X 65MM



▶ JOGO DE BITS 1/4 PHILLIPS MAGNÉTICO 2 PEÇAS



- Ponta Imantada
- Encaixe Sextavado 1/4"

CODIGO	MEDIDA
9298	50MM X 3/16 (PH1)
9299	50MM X 1/4 (PH2)
9300	50MM X 5/16 (PH3)

▶ BITS 1/4 PHILLIPS MAGNÉTICO COM LIMITADOR



- Encaixe Sextavado 1/4"
- Imantado e com limitador
- Tamanho: 25mm | 50mm
- Aplicação para parede Gesso /Drywall



CODIGO	MEDIDA
9301	25MM X 1/4 (PH2)
9302	50MM X 1/4 (PH2)

▶ GRAMPEADOR TAPECEIRO COM CONTROLE DE PRESSÃO



- Para utilização em estofarias
- Ajuste de pressão
- Para grampos tipo 53 de 4 - 14mm
- Corpo em chapa de aço cromado
- Acompanha 50 Grampos
- Compartimento para 100 grampos Tipo 53

CODIGO	GRAMPO
10534	TIPO 53 DE 4 - 14MM



▶ GRAMPOS PARA GRAMPEADOR TIPO 53 CAIXA COM 1.000 PEÇAS



- Temperados
- Embalagem caixa com 1000 peças

CODIGO	MEDIDA
10535	6MM
10536	8MM
10537	10MM
10538	12MM

▶ FUNIL FLEXÍVEL PLÁSTICO



- Flexível
- Com peneira e alça
- Diâmetro: 145mm

CODIGO	MEDIDA
9310	145MM

▶ ALMOTOLIA METÁLICA



- Bomba para óleo
- Bico Flexível regulável
- Corpo metálico

CODIGO	CAPACIDADE
9311	300 ML

▶ APLICADOR DE SILICONE ABERTO



- Metálico | Metallic | Metálico
- Para tubos de até 310g/315ml

CODIGO	CAPACIDADE
9313	TUBOS DE ATE 310G /315ML

▶ APLICADOR DE SILICONE SEMI ABERTO



- O desenho da carcaça é reforçado por nervuras transversais
- Para tubos de até 310g/315ml

CODIGO	CAPACIDADE
9314	TUBOS DE ATE 310G /315ML

▶ PORTA ELETRODO



CODIGO	MEDIDA
9316	300 AMPERES
9317	500 AMPERES

▶ CALIBRADOR DE PNEUS COM MANOMETRO



- Mangueira Flexível
- Bico prendedor para fácil operação
- Válvula de alívio de pressão
- Manômetro para monitoramento de pressão
- Rosca de 1/4"NPT
- Pressão de trabalho 7 BAR (100 PSI)

CODIGO	ROSCA
9309	1/4" NPT

▶ JOGO DE SOQUETE 3/4 ESTRIADOS CURTO 20 PEÇAS



- Aço CrV
 - Caixa metálica
 - Estriado
 - Encaixe 3/4"
- Composição
- 1 catraca de 3/4"
 - 1 cabo de força T de 3/4"
 - 1 extensão de 4" (100 mm)
 - 1 extensão de 8" (200 mm)
 - 16 soquetes: 19, 21, 22, 23, 24, 26, 27, 30, 32, 34, 36, 38, 41, 46, 48 e 50 mm.

CODIGO	COMPOSIÇÃO
10386	20 PEÇAS

▶ PISTOLA PARA LIMPEZA MATALICA



CODIGO	ROSCA
9346	1/4" NPT

▶ BICO SOPRADOR DE AR BOTAO PLASTICO



CODIGO

9203

ROSCA

1/4" NPT

▶ PULVERIZADOR BOTAO DE PLASTICO



CODIGO

9204

ROSCA

1/4" NPT

▶ PISTO DE AR GATILHO DE PLASTICO



CODIGO

9205

ROSCA

1/4" NPT

▶ PISTOLA PULVERIZADORA GATILHO PLASTICO



CODIGO

9206

ROSCA

1/4" NPT

▶ TRINCHA MULTIUSO



- Trincha com cerdas gris selecionadas.
- Indicada para látex e acrílica.

CODIGO

9500

MEDIDA

1/2"

9501

3/4"

9502

1"

9503

1.1/2"

9504

2"

9505

2.1/2"

9506

3"

9507

4"

▶ GAVETA ENCAIXAVEL AZUL

CODIGO	DESCRIÇÃO
10591	Nº3 AZUL C:180MMXA:75MMXL:105MM
10592	Nº5 AZUL C:250MMXA:120MMXL:150MM
10593	Nº7 AZUL C:340MMXA:170MMXL:215MM

▶ GAVETA ENCAIXAVEL PRETA

CODIGO	DESCRIÇÃO
10594	Nº3 PRETA C:180MMXA:75MMXL:105MM
10595	Nº5 PRETA C:250MMXA:120MMXL:150MM
10596	Nº7 PRETA C:340MMXA:170MMXL:215MM

▶ CESTO ENCAIXAVEL PEQUENO AZUL

CODIGO	DESCRIÇÃO
10597	PEQUENO C:440MMXA:200MMXL:340MM

▶ CESTO ENCAIXAVEL PEQUENO PRETO

CODIGO	DESCRIÇÃO
10598	PEQUENO C:440MMXA:200MMXL:340MM

▶ ESTANTE PRATELEIRA COM 6 BANDEJAS 30 CENTÍMETROS

CODIGO	DESCRIÇÃO
10617	ESTANTE PRATELEIRA C/ 6 BANDEJAS 30 CM
10619	BANDEJA AVULSA 30 CM PARA PRATELEIRA
10621	COLUNA AVULSA PARA PRATELEIRA

▶ ESTANTE PRATELEIRA COM 6 BANDEJAS 40 CENTÍMETROS

CODIGO	DESCRIÇÃO
10618	ESTANTE PRATELEIRA C/ 6 BANDEJAS 40 CM
10620	BANDEJA AVULSA 40 CM PARA PRATELEIRA
10621	COLUNA AVULSA PARA PRATELEIRA

▶ ESTANTE COMPLETA COM 30 GAVETAS Nº 3

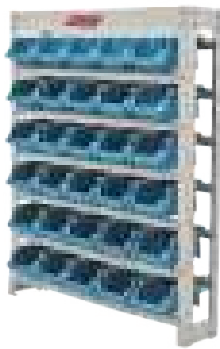

CODIGO	DESCRIÇÃO
10605	ESTANTE COMPLETA COM 30 GAVETAS Nº 3 AZUL
10611	ESTANTE COMPLETA COM 30 GAVETAS Nº 3 PRETA
10599	ARMACAO ACO PARA 30 GAVETAS Nº 3

▶ ESTANTE COMPLETA COM 60 GAVETAS Nº 3



CODIGO	DESCRIÇÃO
10606	ESTANTE COMPLETA COM 60 GAVETAS Nº 3 AZUL
10612	ESTANTE COMPLETA COM 60 GAVETAS Nº 3 PRETA
10600	ARMACAO ACO PARA 60 GAVETAS Nº 3

▶ ESTANTE COMPLETA COM 108 GAVETAS Nº 3

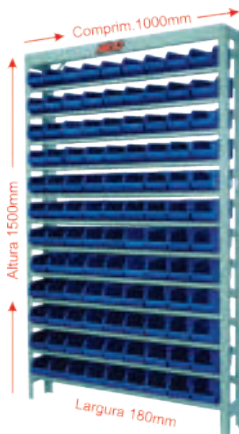

CODIGO	DESCRIÇÃO
10607	ESTANTE COMPLETA COM 108 GAVETAS Nº 3 AZUL
10613	ESTANTE COMPLETA COM 108 GAVETAS Nº 3 PRETA
10601	ARMACAO ACO PARA 108 GAVETAS Nº 3

▶ ESTANTE COMPLETA COM 54 GAVETAS Nº 5

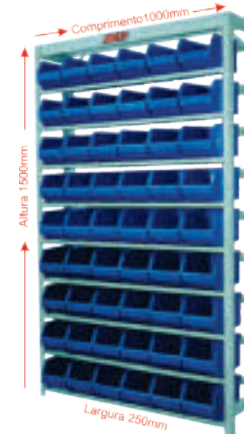

CODIGO	DESCRIÇÃO
10608	ESTANTE COMPLETA COM 54 GAVETAS Nº 5 AZUL
10614	ESTANTE COMPLETA COM 54 GAVETAS Nº 5 PRETA
10602	ARMACAO ACO PARA 54 GAVETAS Nº 5

▶ ESTANTE COMPLETA COM 28 GAVETAS Nº 7

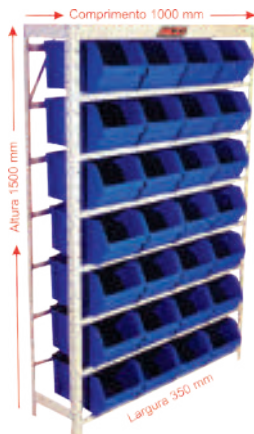

CODIGO	DESCRIÇÃO
10609	ESTANTE COMPLETA COM 28 GAVETAS Nº 7 AZUL
10615	ESTANTE COMPLETA COM 28 GAVETAS Nº 7 PRETA
10603	ARMACAO ACO PARA 28 GAVETAS Nº 7

▶ ESTANTE COMPLETA COM 82 GAVETAS MISTAS Nº 3/5/7

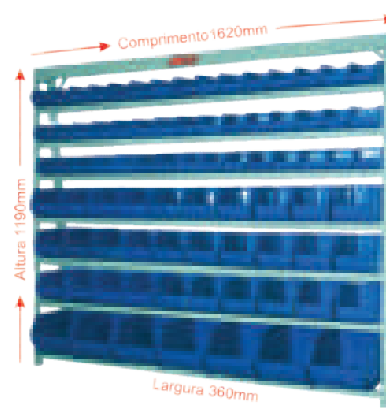

- Gaveta Nº 3 45 unidades
- Gaveta Nº 3 30 unidades
- Gaveta Nº 3 7 unidades

CODIGO	DESCRIÇÃO
10610	ESTANTE COMPLETA COM 82 GAVETAS Nº 3/5/7 AZUL
10616	ESTANTE COMPLETA COM 82 GAVETAS Nº 3/5/7 PRETA
10604	ARMACAO ACO PARA 82 GAVETAS MISTAS Nº 3/5/7

PARAFUSO BROCANTE CABEÇA CHATA PHILLIPS ZINCADO

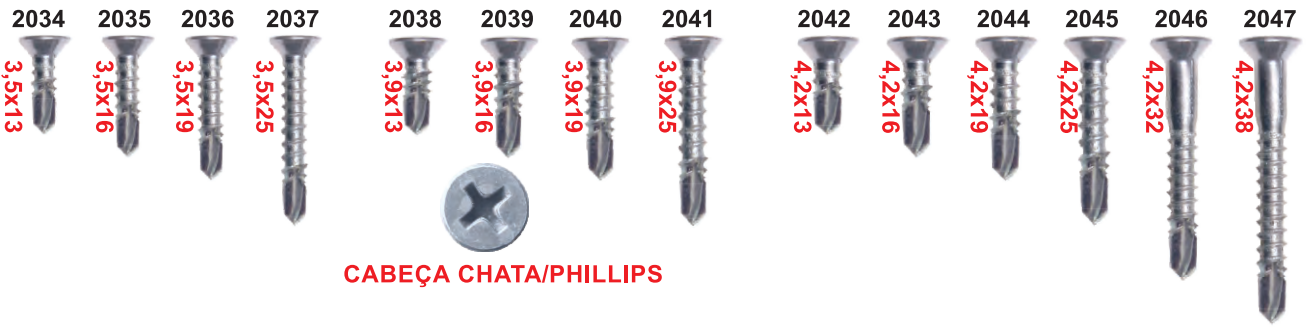

PARAFUSO BROCANTE CABEÇA PANELA PHILLIPS ZINCADO

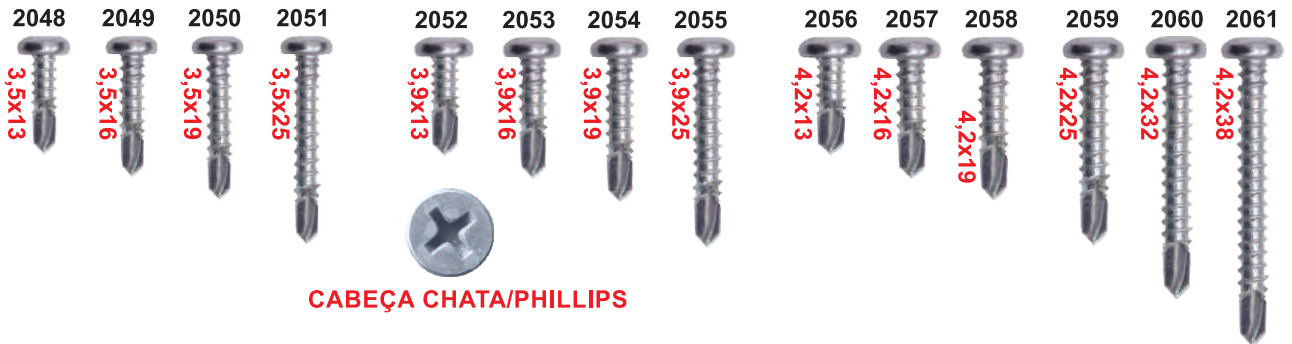

PARAFUSOS PARA DRYWALL E FORRO PVC

CABEÇA FLANGEADA PONTA BROCA

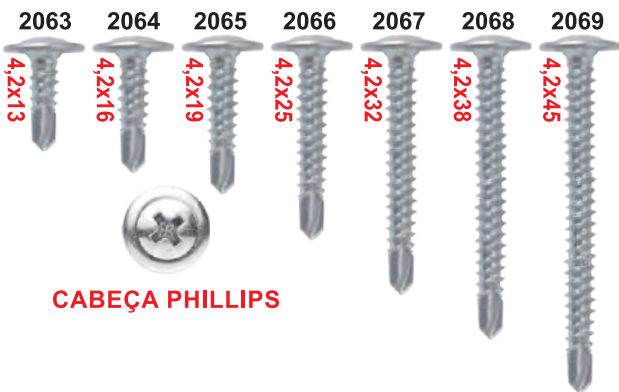

CABEÇA FLANGEADA PONTA BROCA SERRILHADA

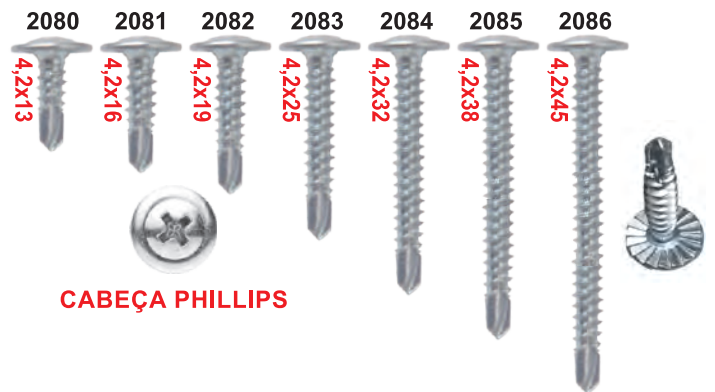

CABEÇA TROMBETA PONTA BROCA

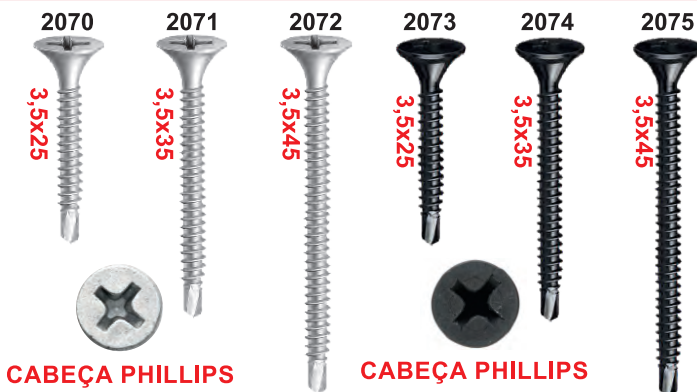

CABEÇA TROMBETA PONTA AGULHA



CABEÇA FLANGEADA PONTA AGULHA



CABEÇA CHATA PONTA BROCA COM ASSA



PARAFUSO ROSCA SOBERBA CABEÇA CHATA PHILLIPS ZINCADO

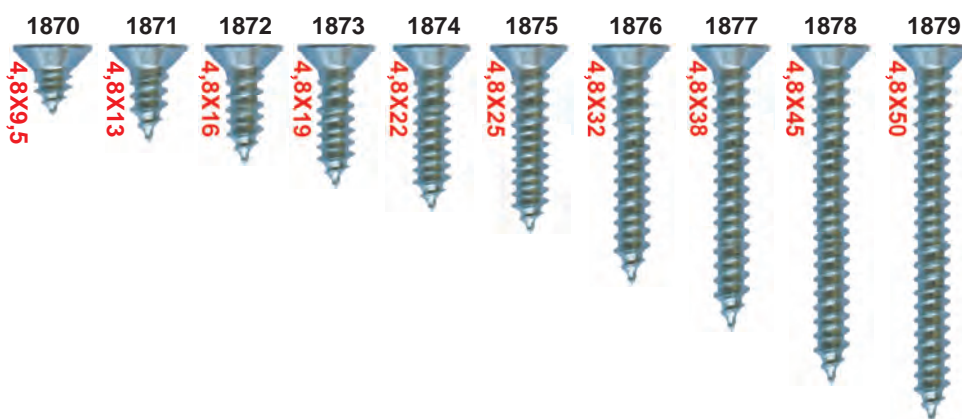
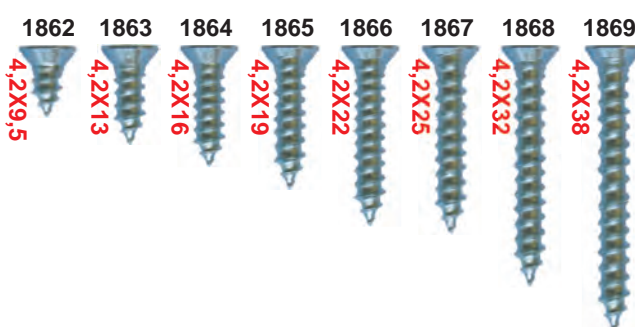
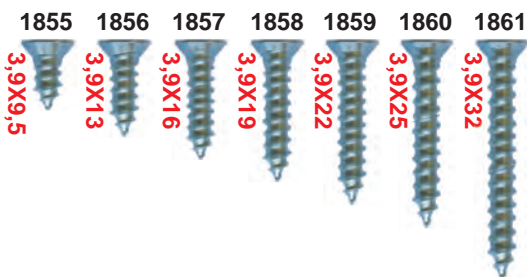
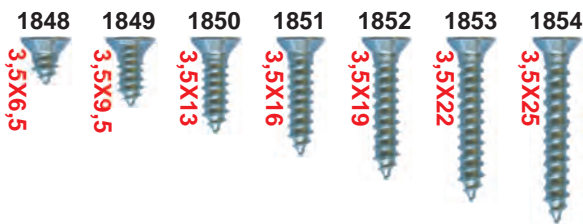
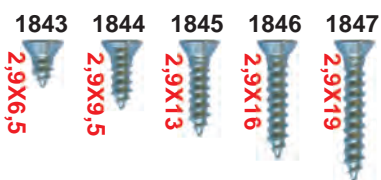

CABEÇA CHATA/PHILLIPS

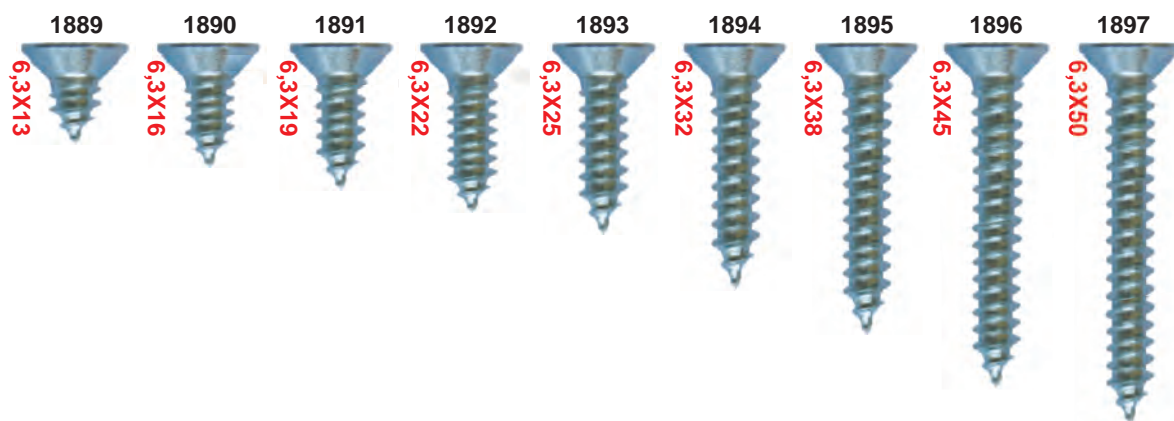
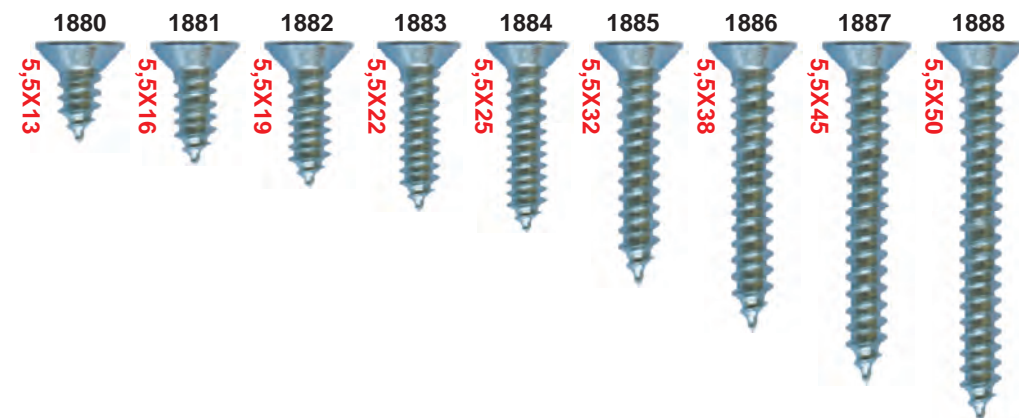

PARAFUSO ROSCA SOBERBA CABEÇA PANELA PHILLIPS ZINCADO E PRETO

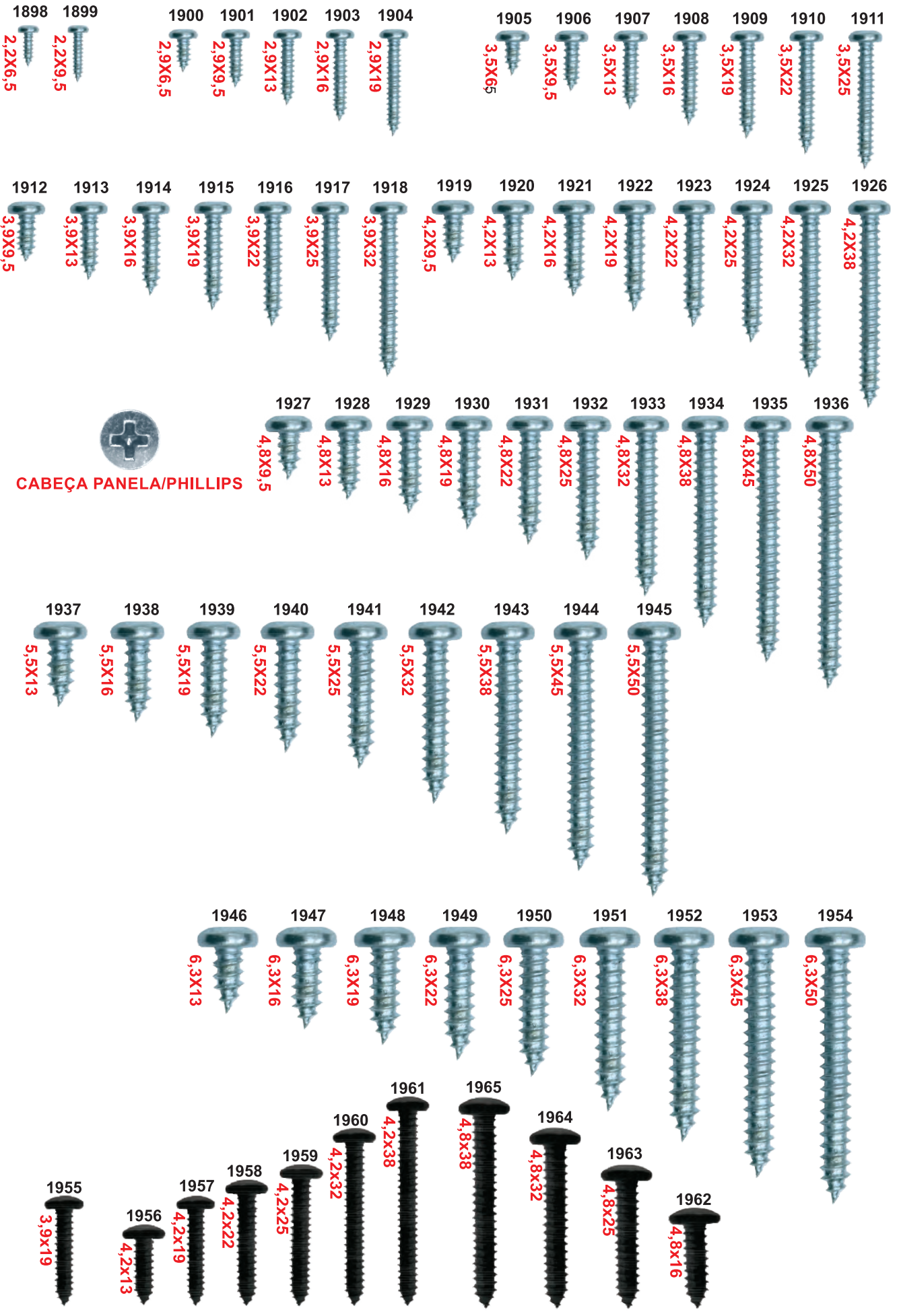

PARAFUSO CHIPBOARD CABEÇA CHATA PHILLIPS BICROMATIZADO



CABEÇA CHATA/PHILLIPS

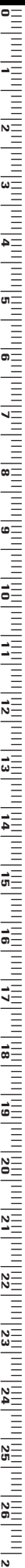
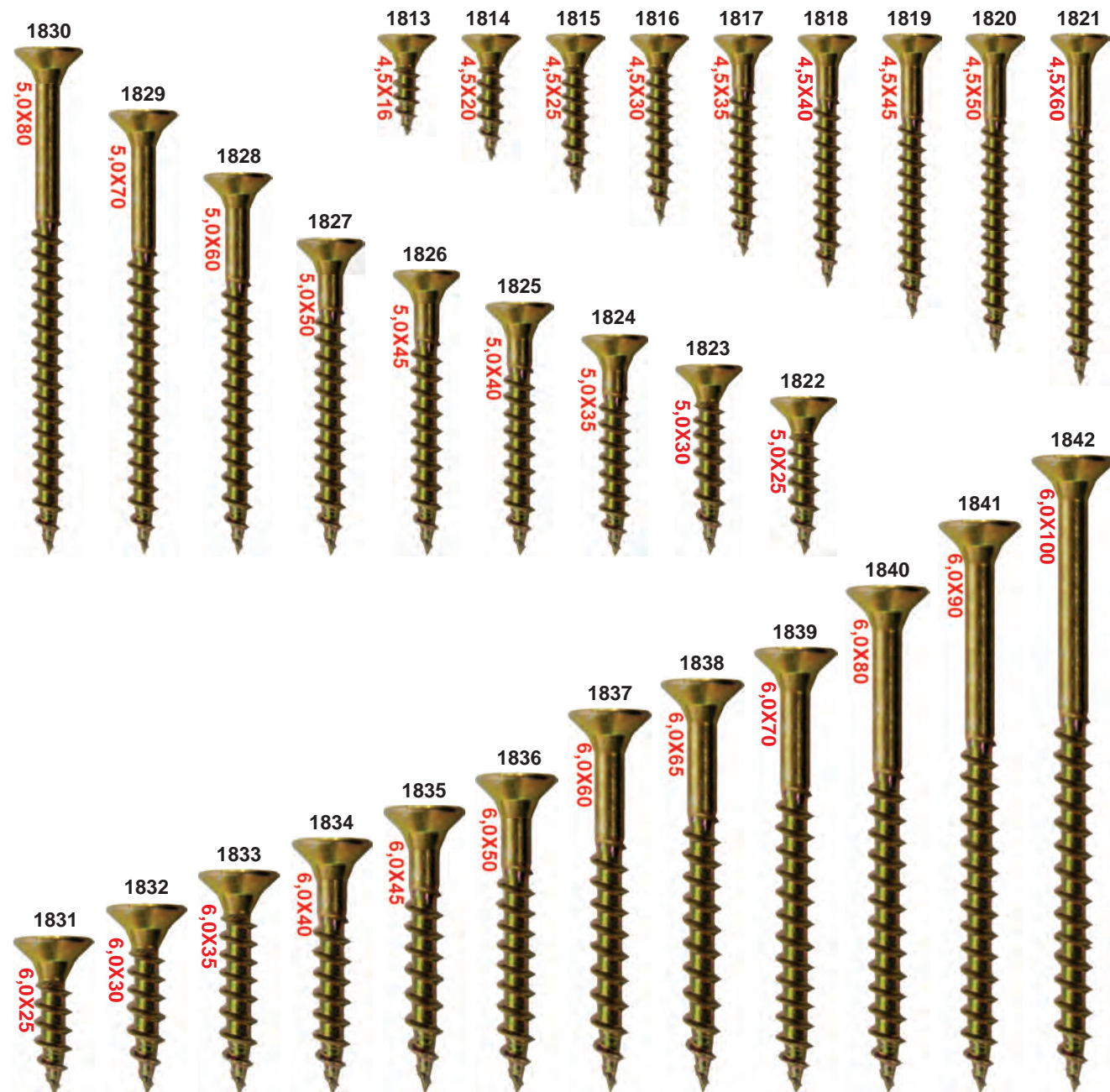

PARAFUSO ROSCA SOBERBA CABEÇA FLANGE PHILLIPS BICROMATIZADO

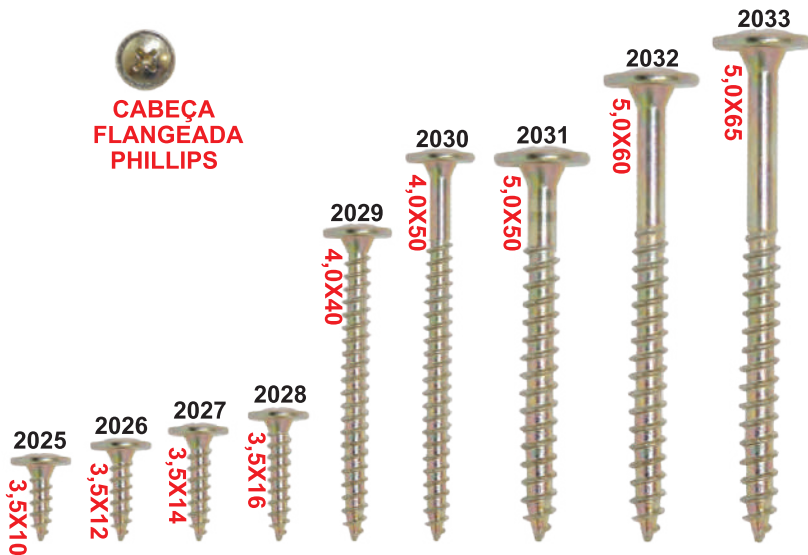

PARAFUSO CHIPBOARD CABEÇA TAMPINHA PHILLIPS BICROMATIZADO



PARAFUSO CHIPBOARD CABEÇA TAMPINHA PHILLIPS ZINCADO



0
1
2
3
4
5
6
7
8
9
10
11
12
13
14
15
16
17
18
19
20
21
22
23
24
25
26
27

PARAFUSO ROSCA SOBERBA CABEÇA SEXTAVADA ZINCADO

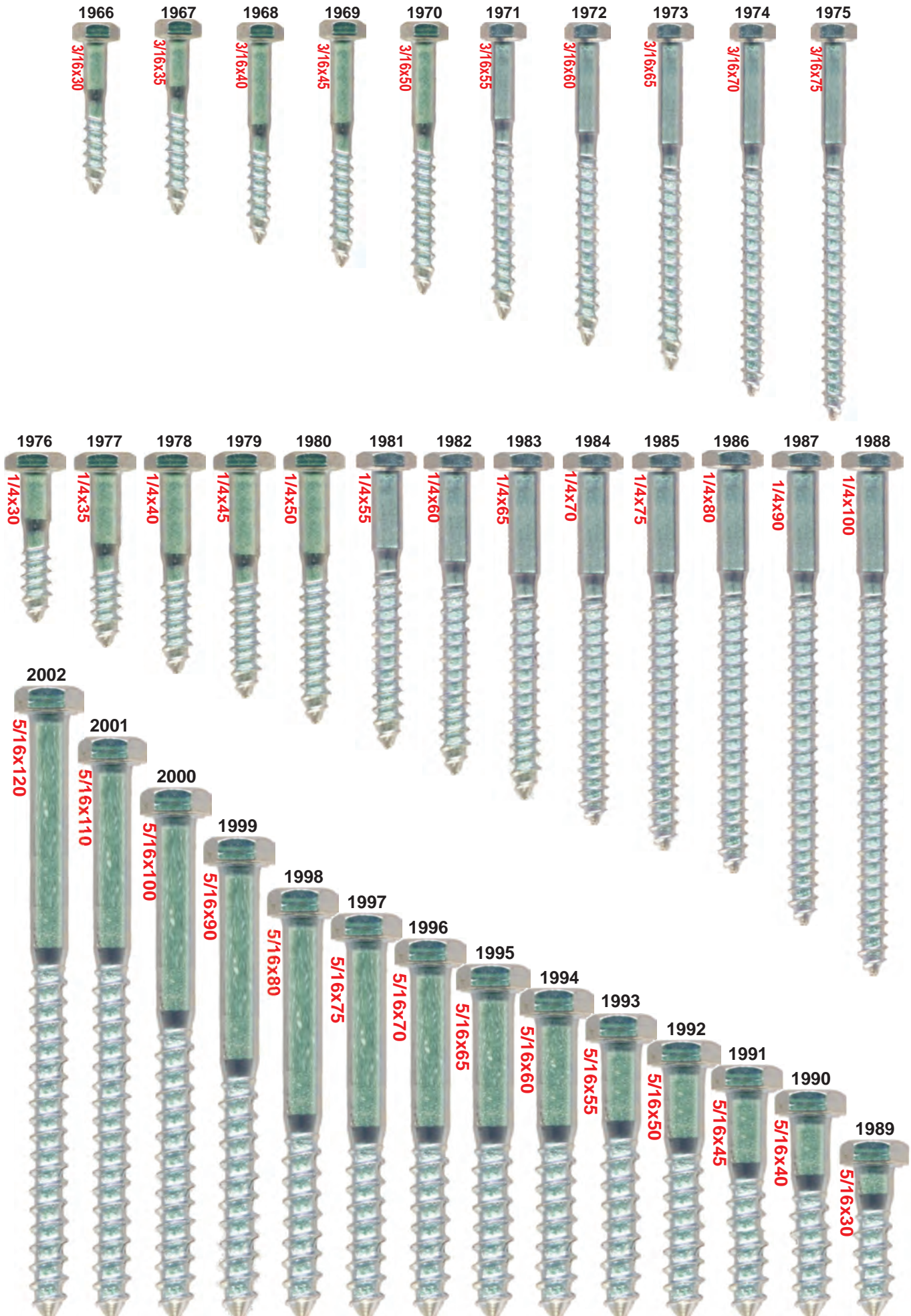

PARAFUSO ROSCA SOBERBA CABEÇA SEXTAVADA ZINCADO



PARAFUSO ROSCA SOBERBA CABEÇA SEXTAVADA ZINCADO

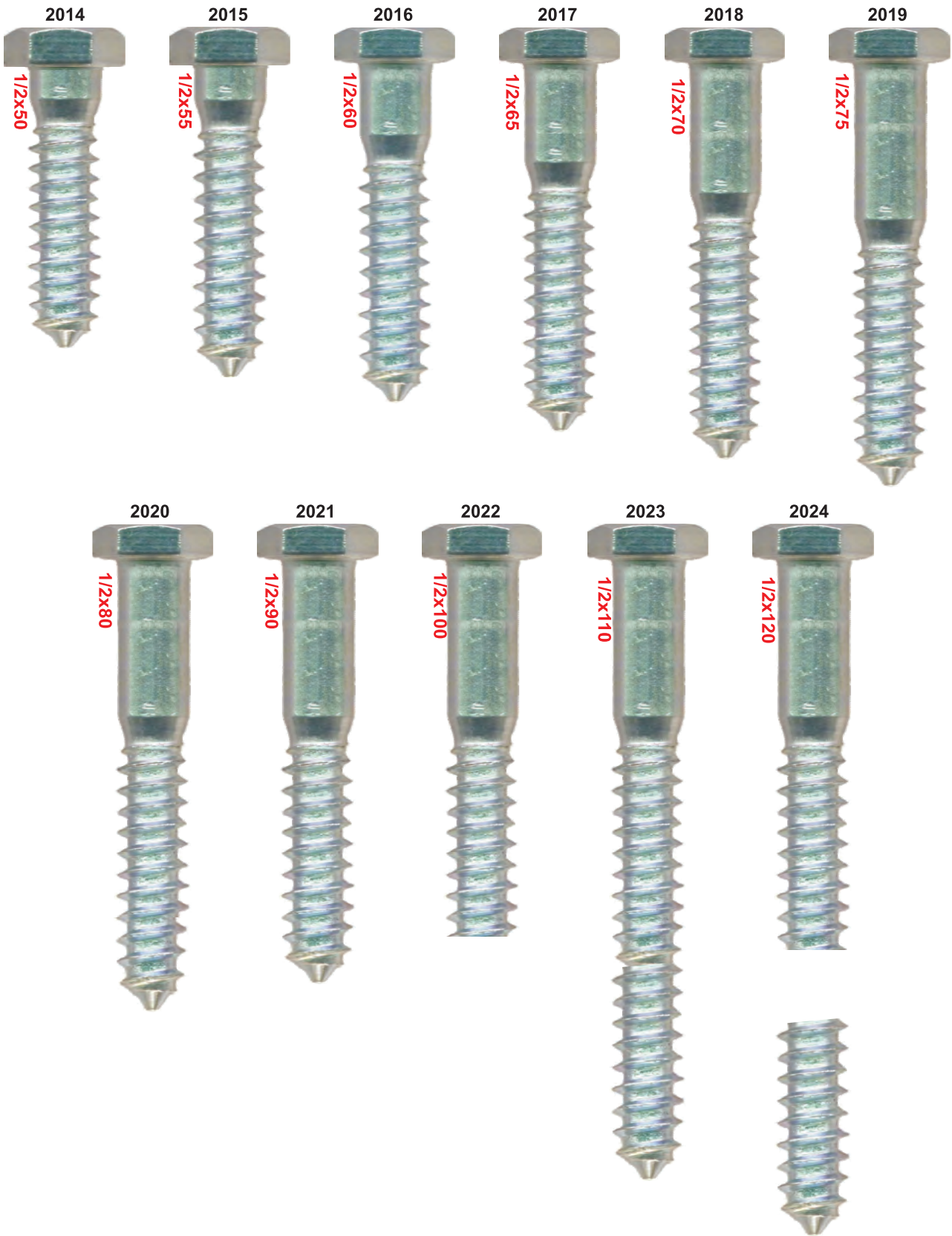

PARAFUSO ROSCA MAQUINA CABEÇA PANELA PHILLIPS BICROMATIZADO

ESPESSURA - 4 mm

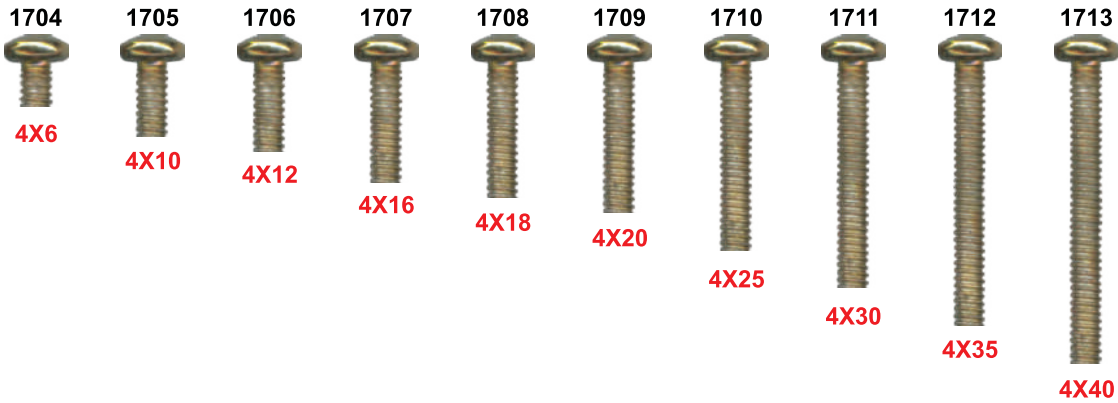

ESPESSURA - 5 mm

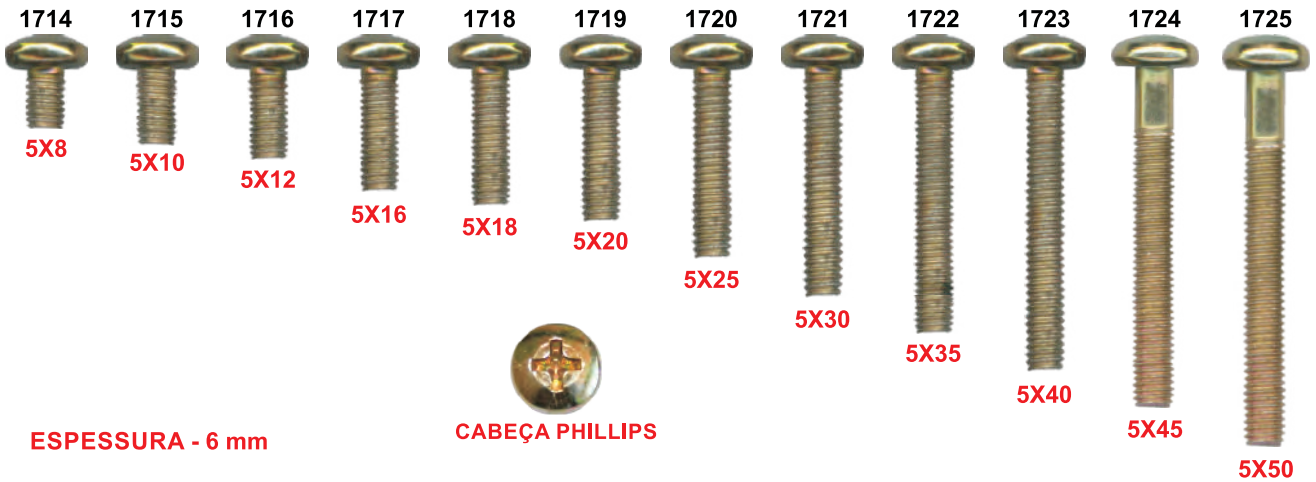

ESPESSURA - 6 mm

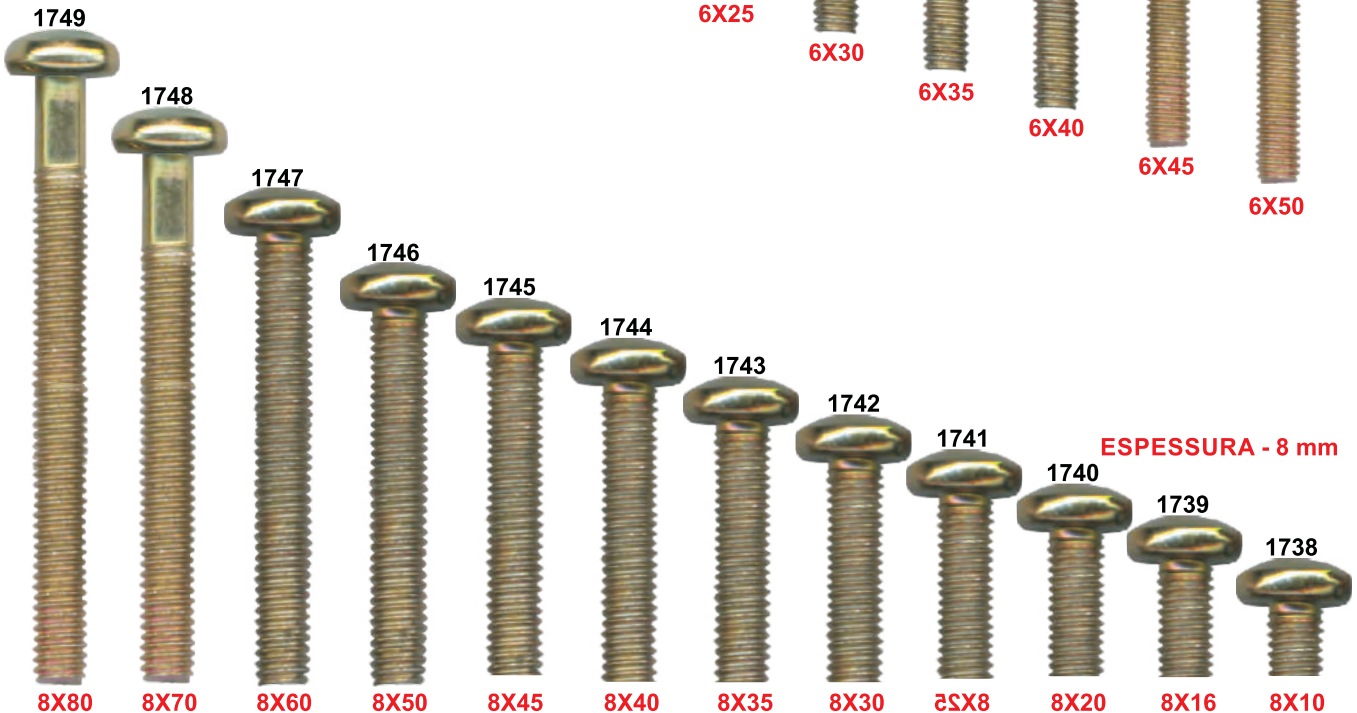
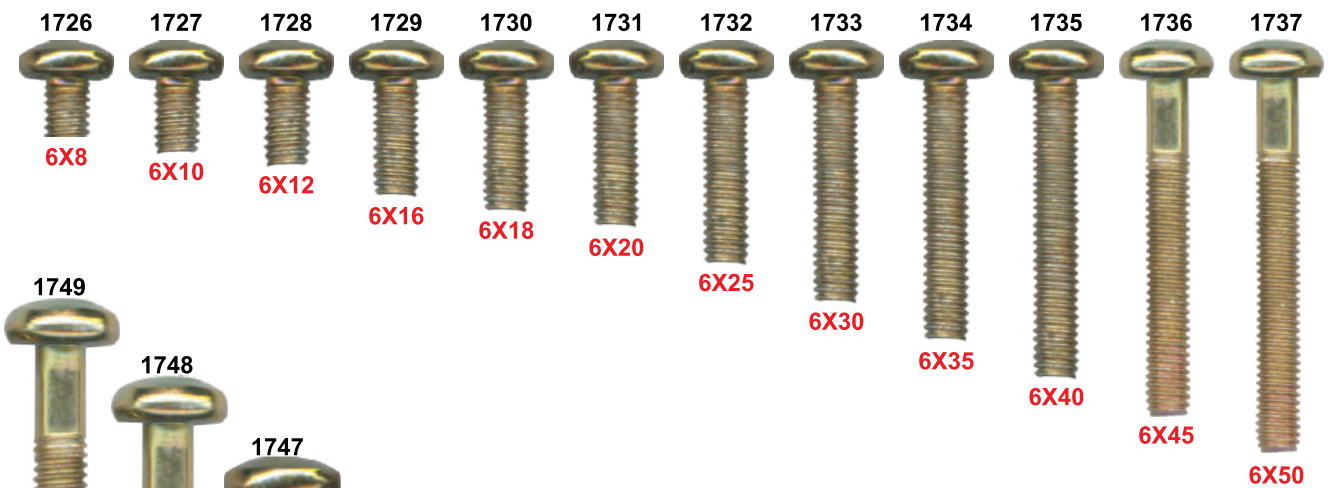

ESPESSURA - 8 mm



PARAFUSO ROSCA MAQUINA CABEÇA CHATA PHILLIPS BICROMATIZADO

ESPESSURA - 4 mm



CABEÇA PHILLIPS

ESPESSURA - 5 mm

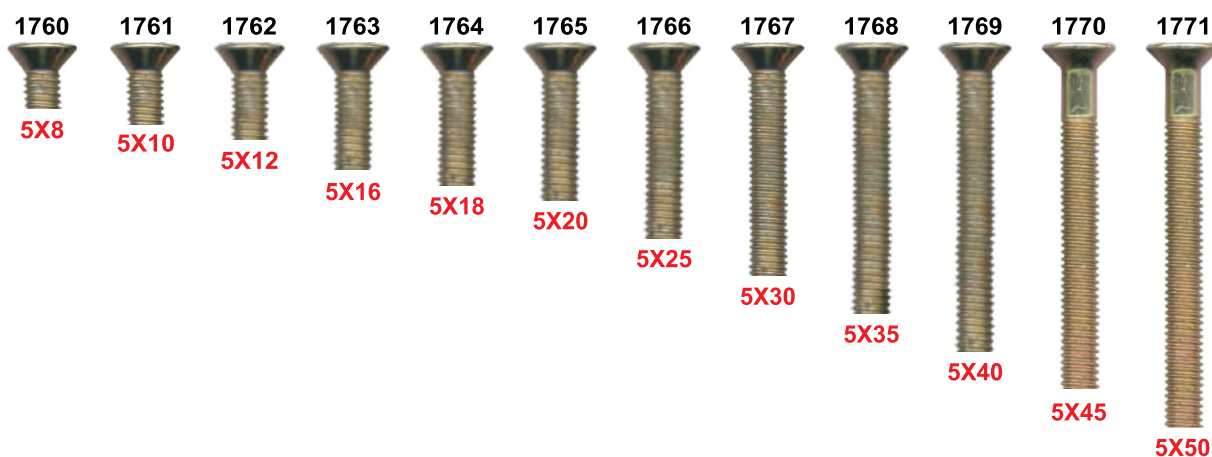

ESPESSURA - 6 mm

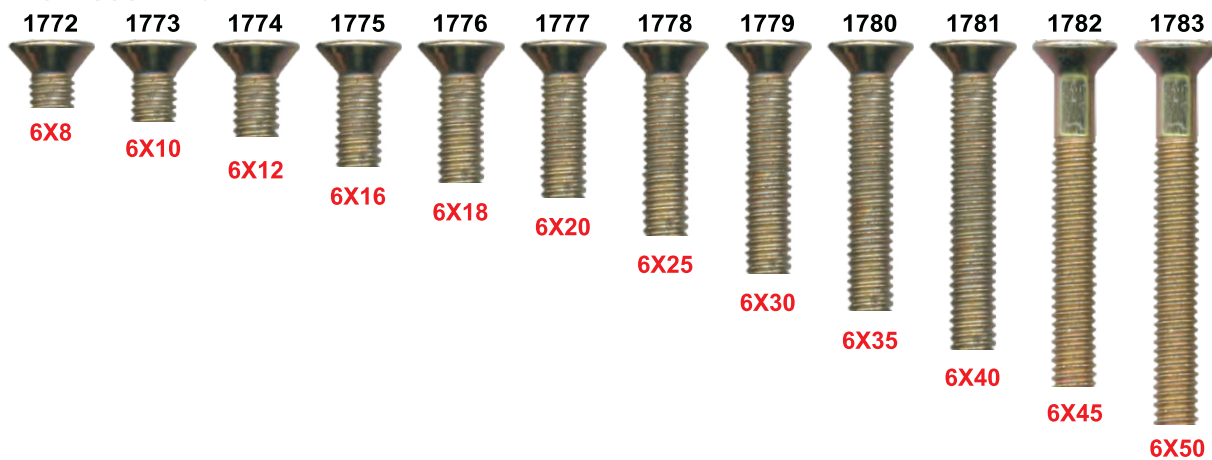

PARAFUSO SEXTAVADO COM FLANGE CHAVE 8 ZINCADO

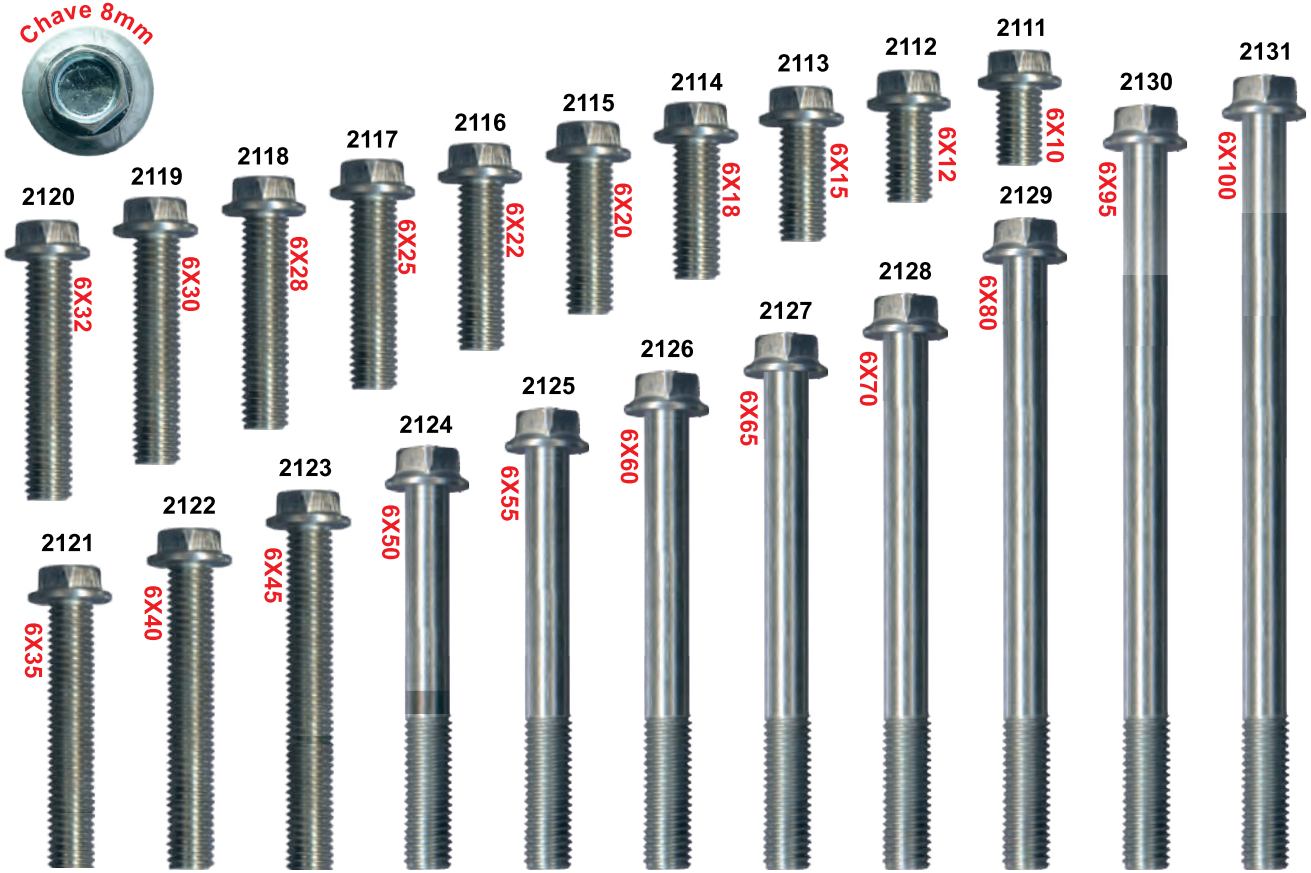

PARAFUSO SEXTAVADO COM FLANGE CHAVE 8 CROMADO

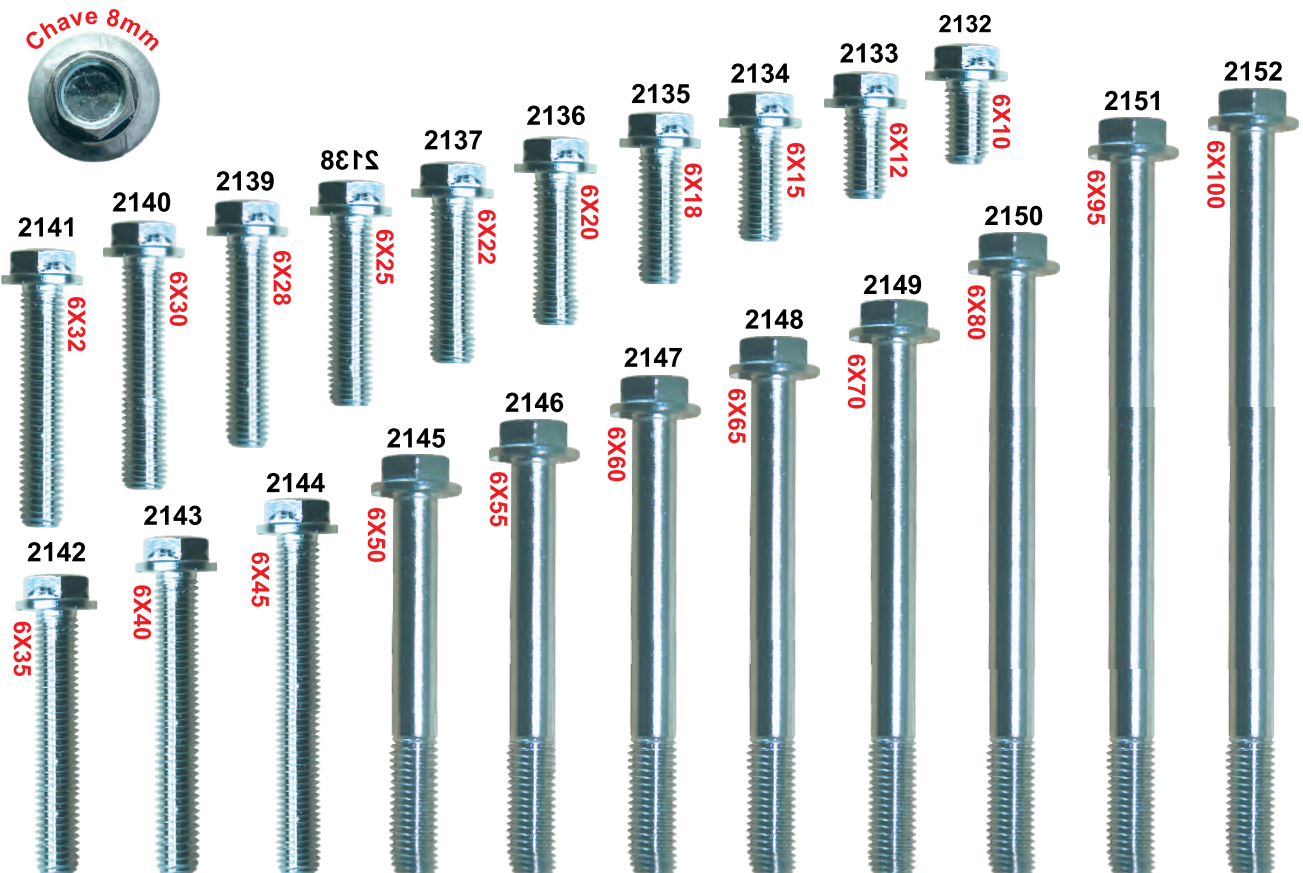

PARAFUSO SEXTAVADO COM FLANGE CHAVE 10 ZINCADO



PARAFUSO SEXTAVADO COM FLANGE CHAVE 13 ZINCADO

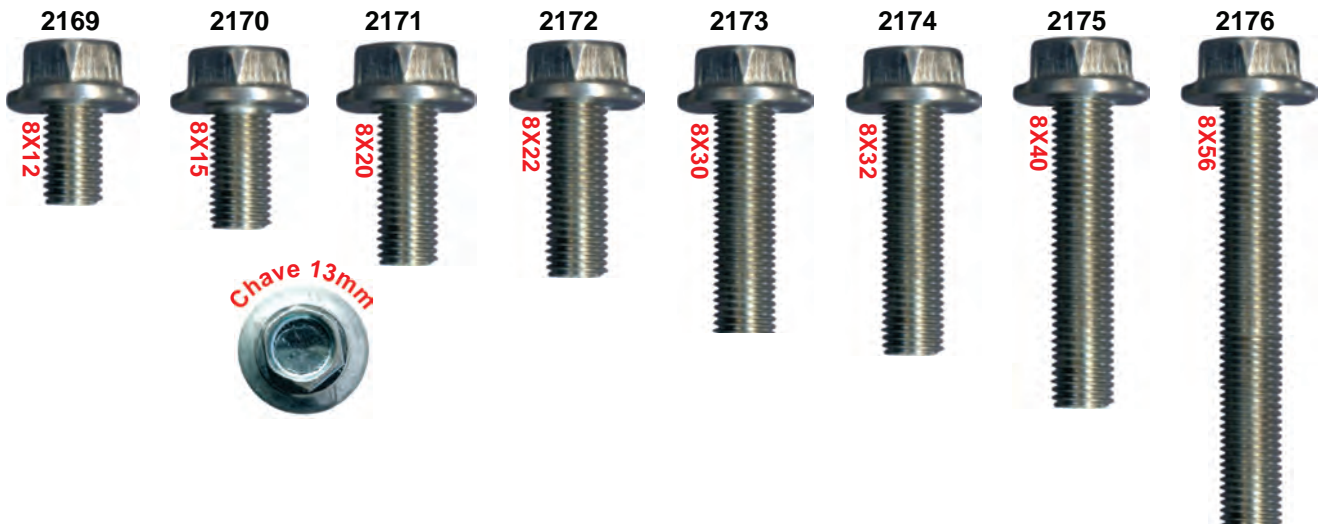

PARAFUSO SEXTAVADO FLANGEADO AÇO 10.9 ROSCA GROSSA (MA)



MEDIDA	FIO DE ROSCA	CHAVE
8MM	1,25	13MM
10MM	1,50	15MM
12MM	1,50	16MM



PARAFUSO SEXTAVADO FLANGEADO AÇO 10.9 ROSCA FINA (MB)



CODIGO	MEDIDA	ROSCA	CHAVE
2200	M-14X30	1,50	18MM
2201	M-14X35	1,50	18MM
2202	M-14X40	1,50	18MM
2203	M-14X45	1,50	18MM
2204	M-14X50	1,50	18MM
2205	M-14X60	1,50	18MM
2206	M-14X70	1,50	18MM
2207	M-14X80	1,50	18MM
2208	M-16X50	1,50	21MM
2209	M-16X55	1,50	21MM
2210	M-16X65	1,50	21MM

PARAFUSO ALLEN SEM CABEÇA ROSCA GROSSA (MA)



CODIGO	MEDIDA	ROSCA	CHAVE
10723	M-4X6	0,70	ALLEN 2MM
10724	M-4X8	0,70	ALLEN 2MM
10725	M-4X10	0,70	ALLEN 2MM
10726	M-4X12	0,70	ALLEN 2MM
10727	M-4X16	0,70	ALLEN 2MM
10728	M-4X20	0,70	ALLEN 2MM
10729	M-5X10	0,80	ALLEN 2,50MM
10730	M-5X12	0,80	ALLEN 2,50MM
10731	M-5X16	0,80	ALLEN 2,50MM
10732	M-5X20	0,80	ALLEN 2,50MM
10733	M-5X25	0,80	ALLEN 2,50MM
10734	M-6X6	1,00	ALLEN 3MM
10735	M-6X8	1,00	ALLEN 3MM
10736	M-6X10	1,00	ALLEN 3MM
10737	M-6X12	1,00	ALLEN 3MM
10738	M-6X16	1,00	ALLEN 3MM
10739	M-6X20	1,00	ALLEN 3MM
10740	M-6X25	1,00	ALLEN 3MM
10741	M-6X30	1,00	ALLEN 3MM

10742	M-8X8	1,25	ALLEN 4MM
10743	M-8X10	1,25	ALLEN 4MM
10744	M-8X12	1,25	ALLEN 4MM
10745	M-8X16	1,25	ALLEN 4MM
10746	M-8X20	1,25	ALLEN 4MM
10747	M-8X25	1,25	ALLEN 4MM
10748	M-8X30	1,25	ALLEN 4MM
10749	M-8X35	1,25	ALLEN 4MM
10750	M-8X40	1,25	ALLEN 4MM
10751	M-8X60	1,25	ALLEN 4MM
10752	M-10X10	1,50	ALLEN 5MM
10753	M-10X12	1,50	ALLEN 5MM
10754	M-10X16	1,50	ALLEN 5MM
10755	M-10X20	1,50	ALLEN 5MM
10756	M-10X25	1,50	ALLEN 5MM
10757	M-10X30	1,50	ALLEN 5MM
10758	M-10X35	1,50	ALLEN 5MM
10759	M-10X45	1,50	ALLEN 5MM
10760	M-10X50	1,50	ALLEN 5MM
10761	M-10X70	1,50	ALLEN 5MM
10762	M-12X12	1,75	ALLEN 6MM
10763	M-12X16	1,75	ALLEN 6MM
10764	M-12X20	1,75	ALLEN 6MM
10765	M-12X25	1,75	ALLEN 6MM
10766	M-12X30	1,75	ALLEN 6MM
10767	M-12X40	1,75	ALLEN 6MM
10768	M-12X50	1,75	ALLEN 6MM
10769	M-12X60	1,75	ALLEN 6MM

PARAFUSO SEXTAVADO AÇO 8.8 ROSCA GROSSA (MA) M-6

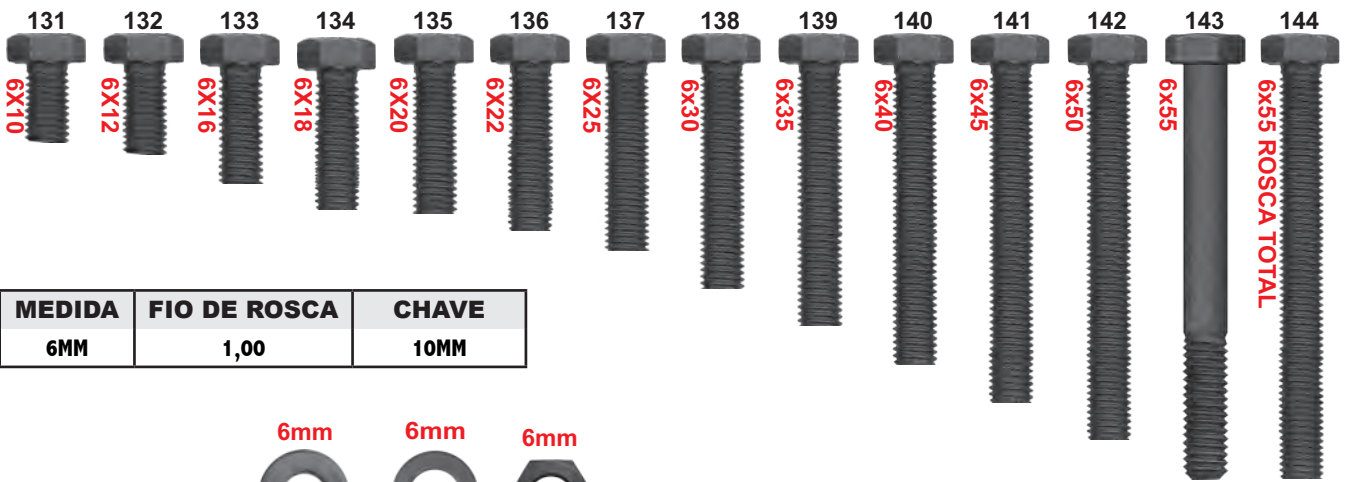

MEDIDA	FIO DE ROSCA	CHAVE
6MM	1,00	10MM

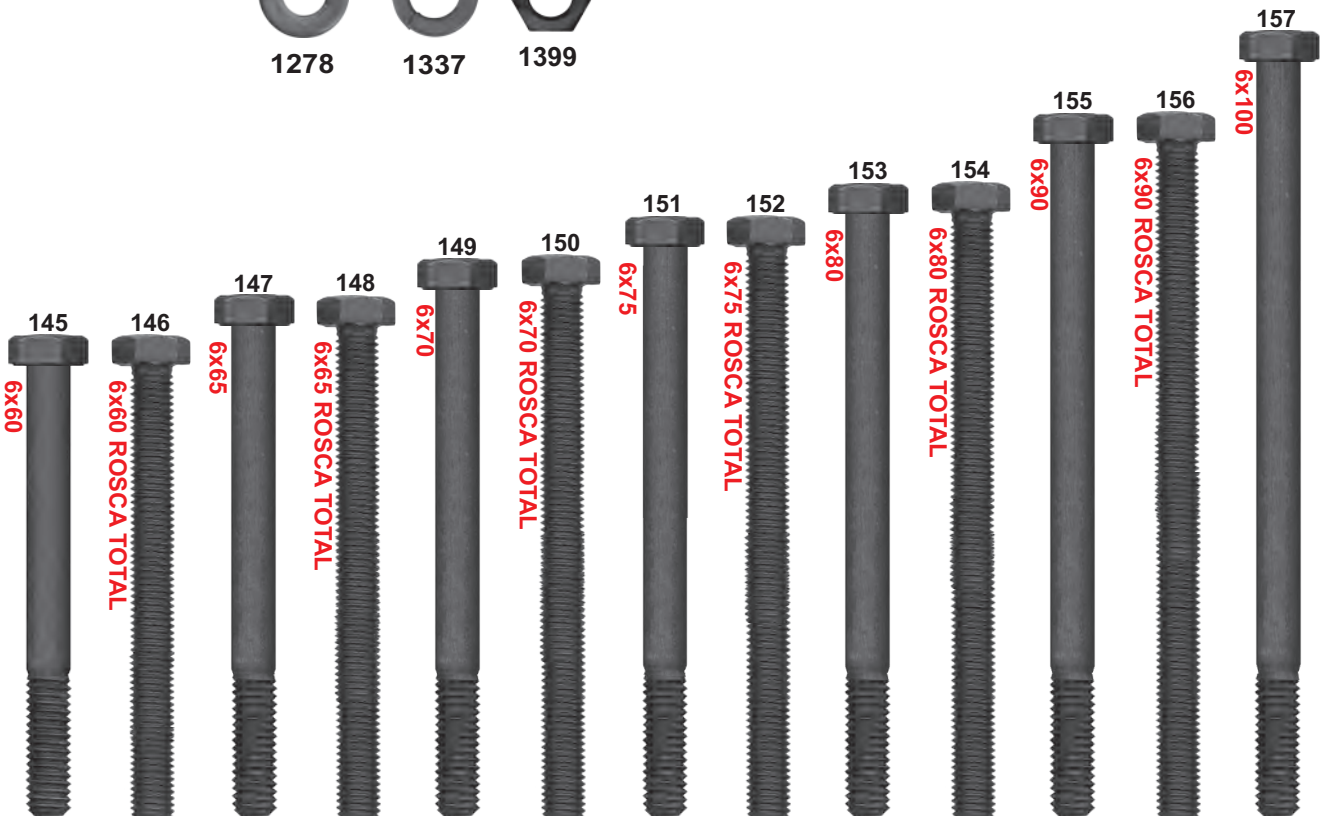
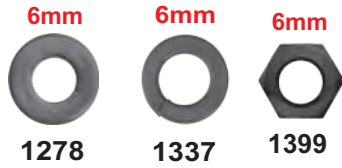

PARAFUSO SEXTAVADO AÇO 8.8 ROSCA GROSSA (MA) M-7

MEDIDA	FIO DE ROSCA	CHAVE
7MM	1,00	11MM

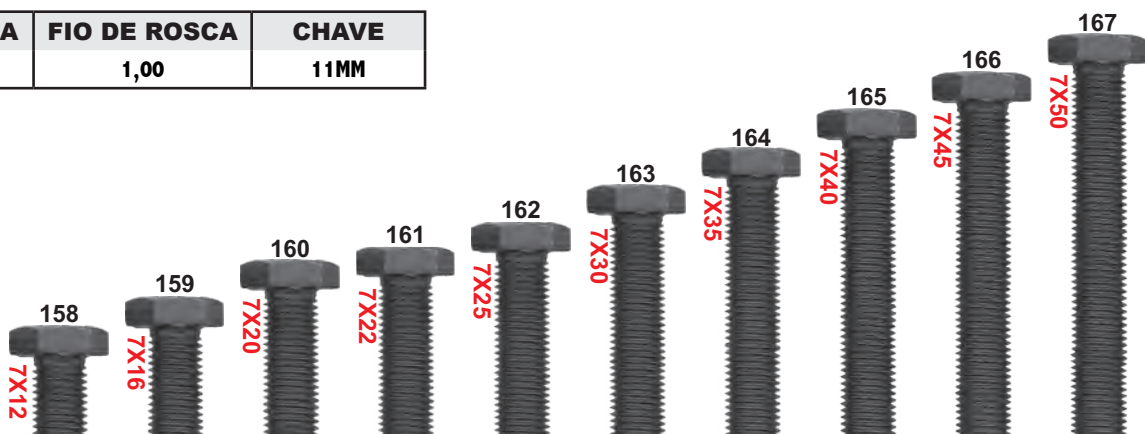

PARAFUSO SEXTAVADO AÇO 8.8 ROSCA GROSSA (MA) M-8



MEDIDA	FIO DE ROSCA	CHAVE
8MM	1,25	13MM

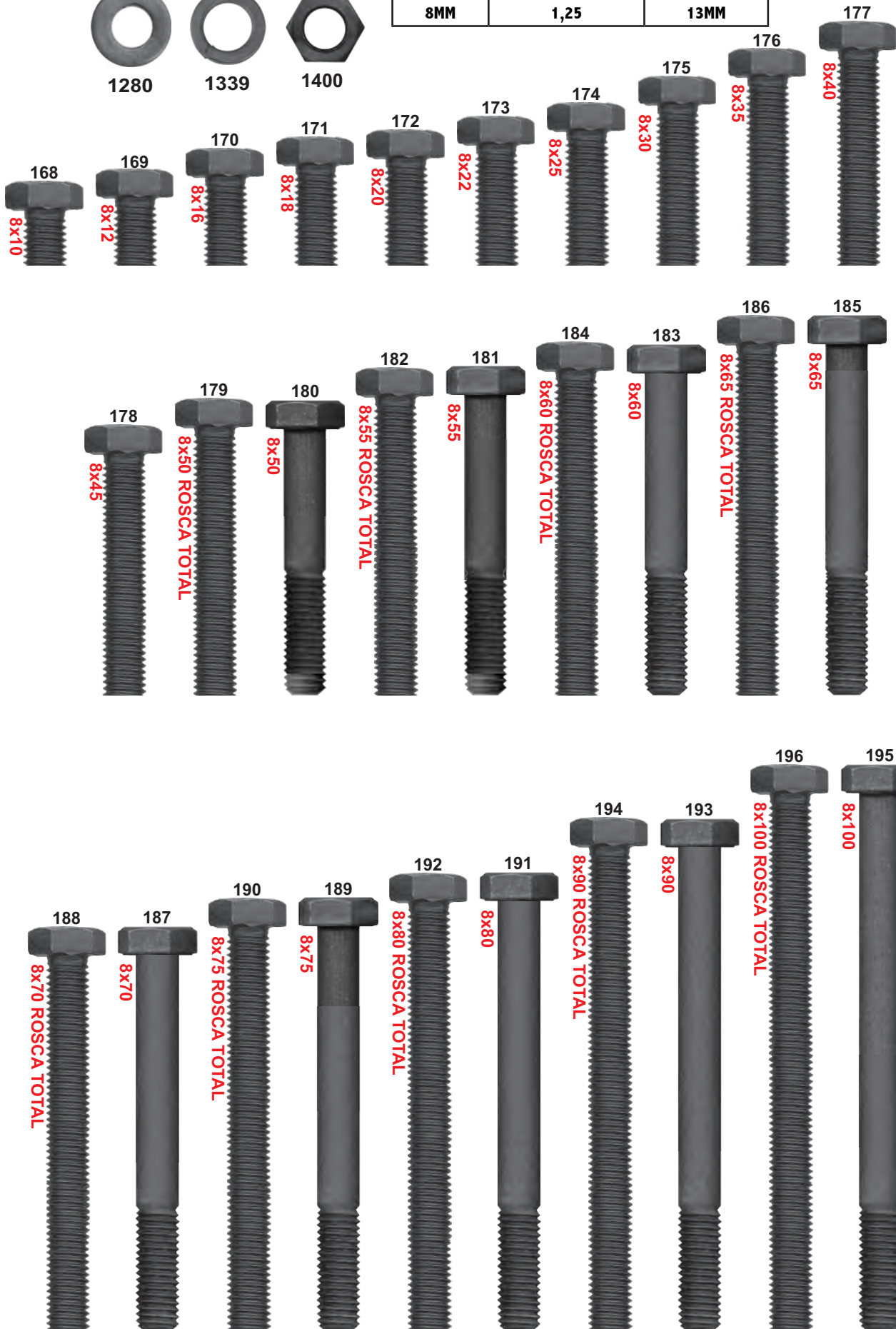

PARAFUSO SEXTAVADO AÇO 8.8 ROSCA GROSSA (MA) M-8

MEDIDA	FIO DE ROSCA	CHAVE
8MM	1,25	13MM

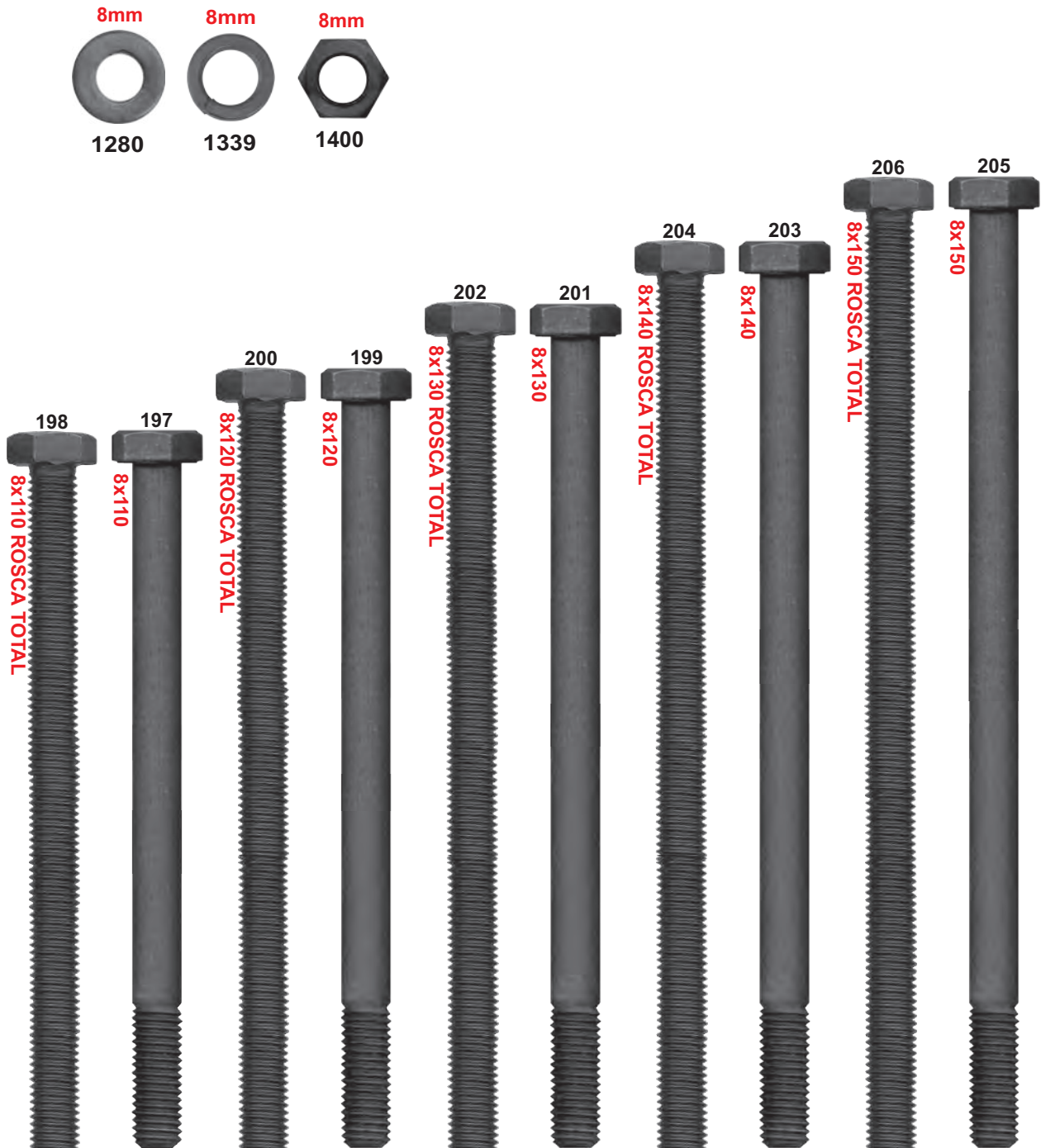

PARAFUSO SEXTAVADO AÇO 8.8 ROSCA GROSSA (MA) M-10

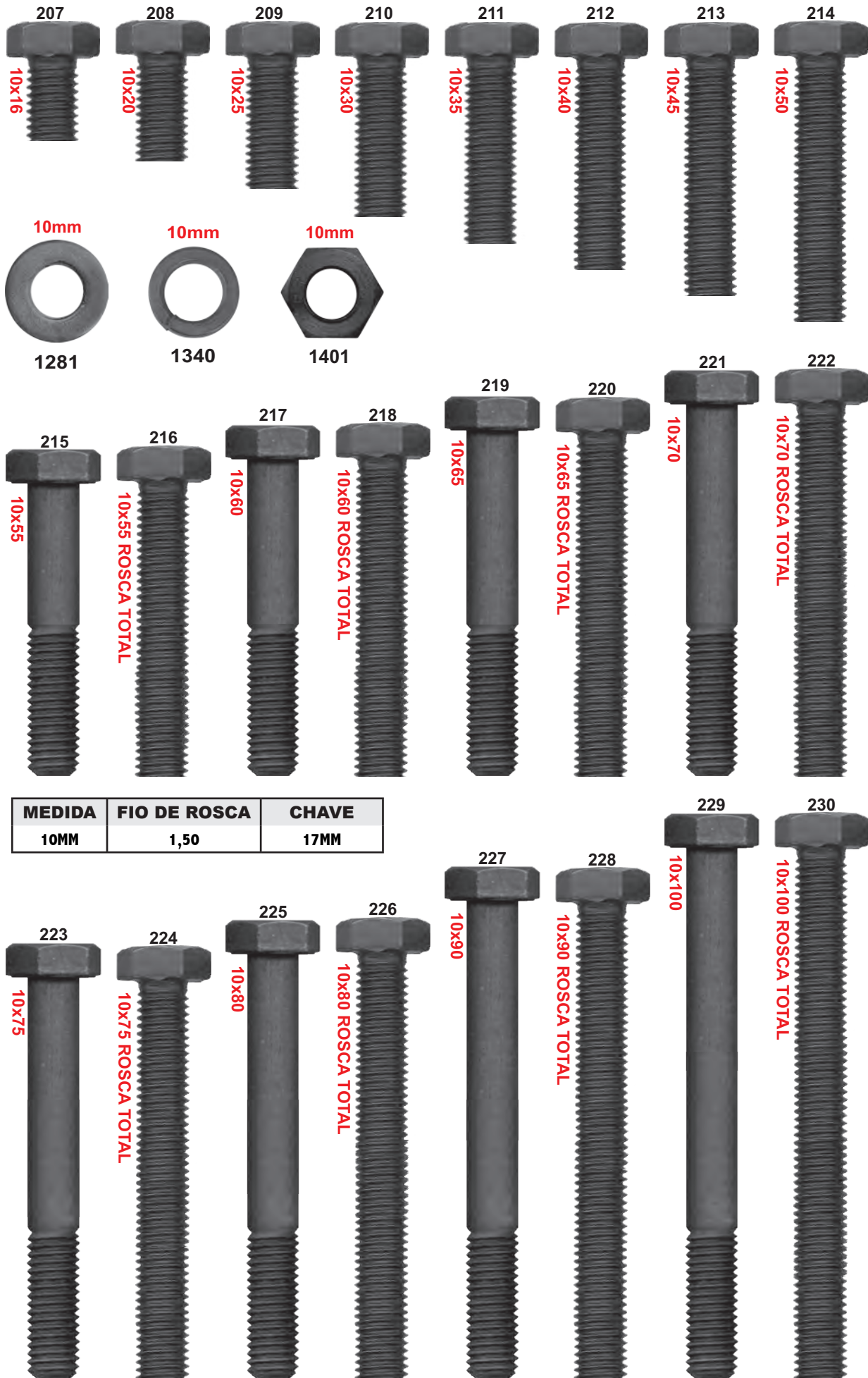

MEDIDA	FIO DE ROSCA	CHAVE
10MM	1,50	17MM



PARAFUSO SEXTAVADO AÇO 8.8 ROSCA GROSSA (MA) M-10

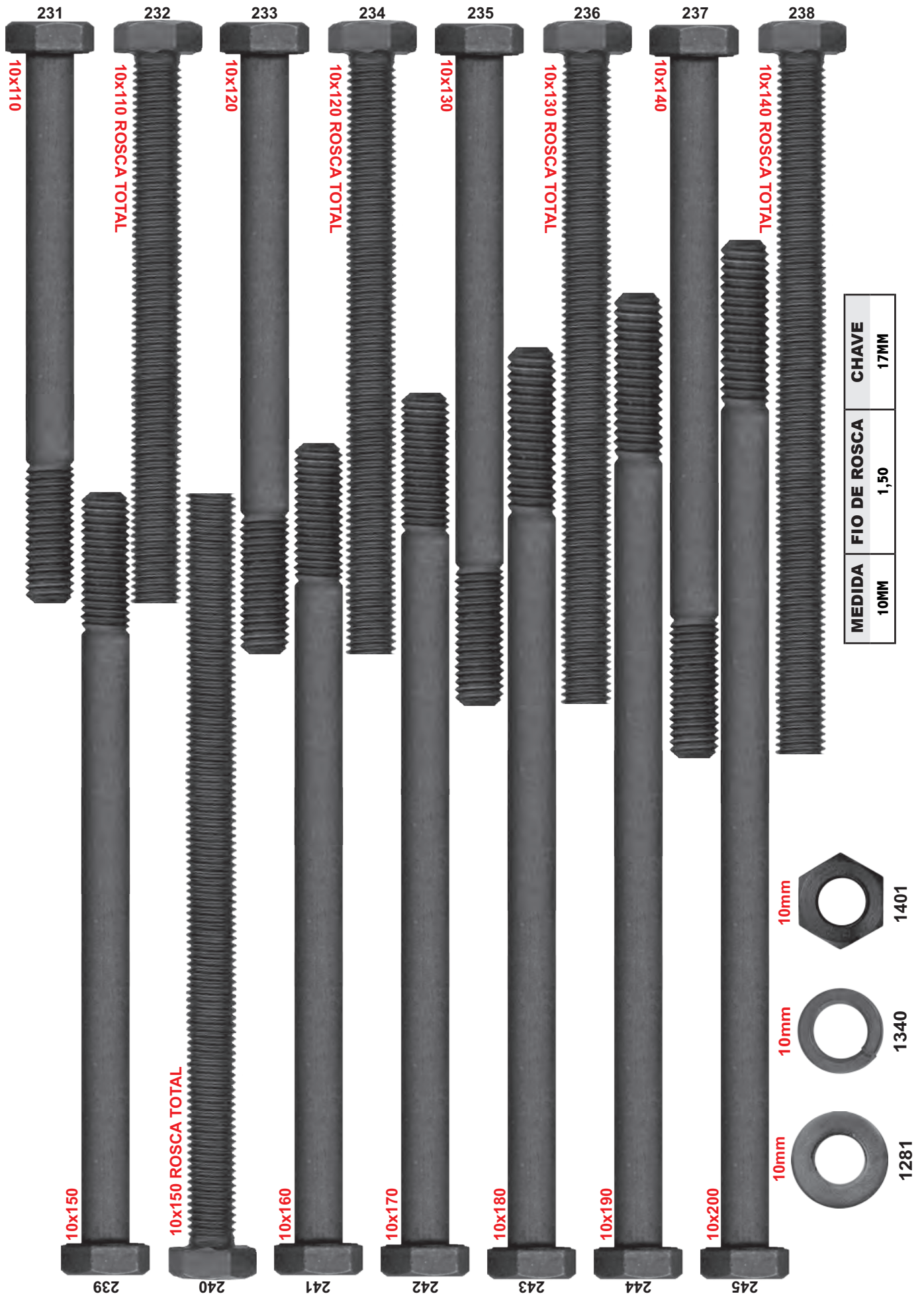

MEDIDA	FIO DE ROSCA	CHAVE
10MM	1,50	17MM

PARAFUSO SEXTAVADO AÇO 8.8 ROSCA GROSSA (MA) M-12

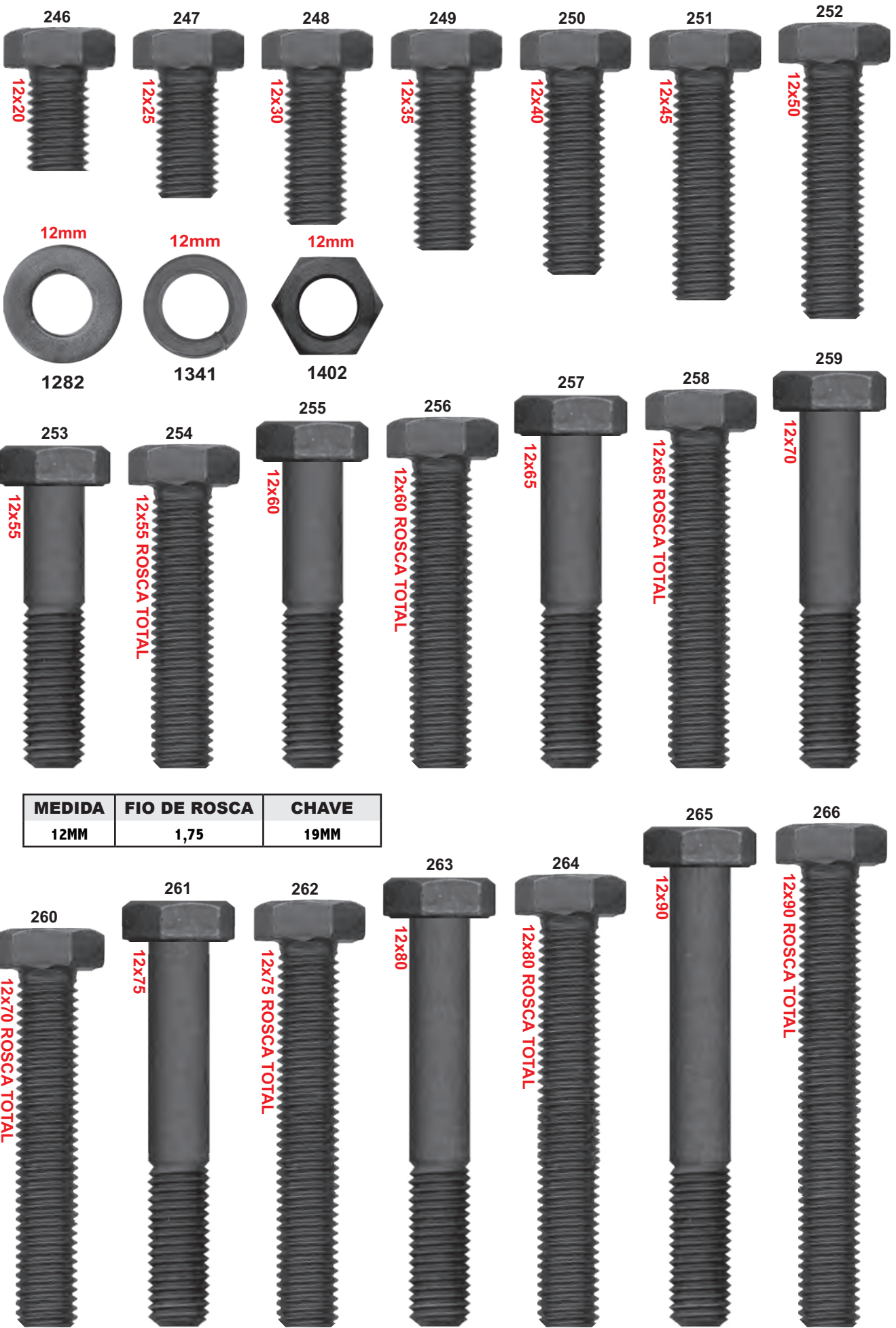

MEDIDA	FIO DE ROSCA	CHAVE
12MM	1,75	19MM

PARAFUSO SEXTAVADO AÇO 8.8 ROSCA GROSSA (MA) M-12



MEDIDA	FIO DE ROSCA	CHAVE
12MM	1,75	19MM



PARAFUSO SEXTAVADO AÇO 8.8 ROSCA GROSSA (MA) M-12



MEDIDA	FIO DE ROSCA	CHAVE
12MM	1,75	19MM

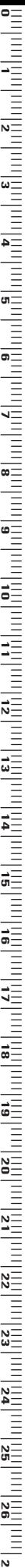
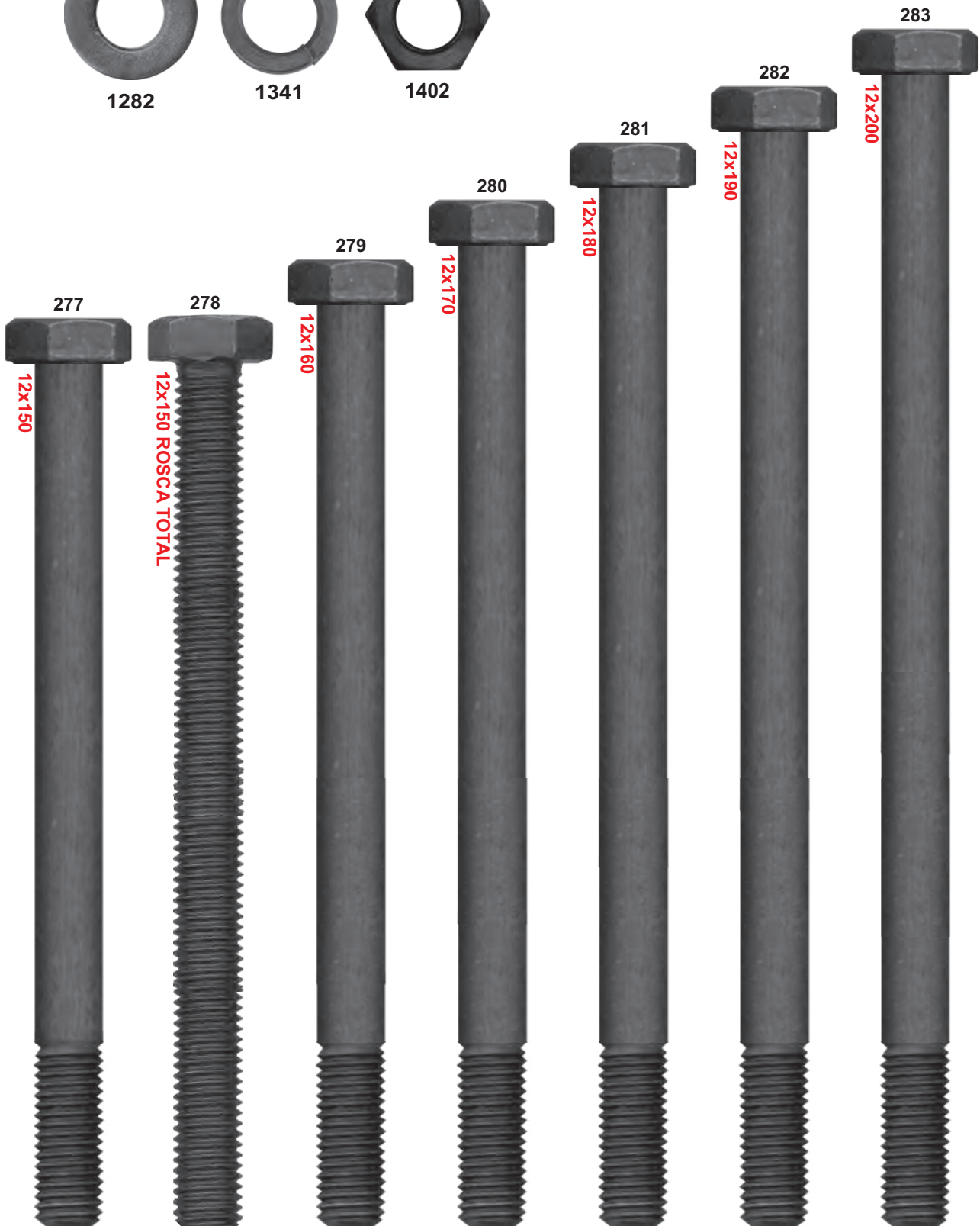

PARAFUSO SEXTAVADO AÇO 8.8 ROSCA GROSSA (MA) M-14



MEDIDA	FIO DE ROSCA	CHAVE
14MM	2,00	22MM

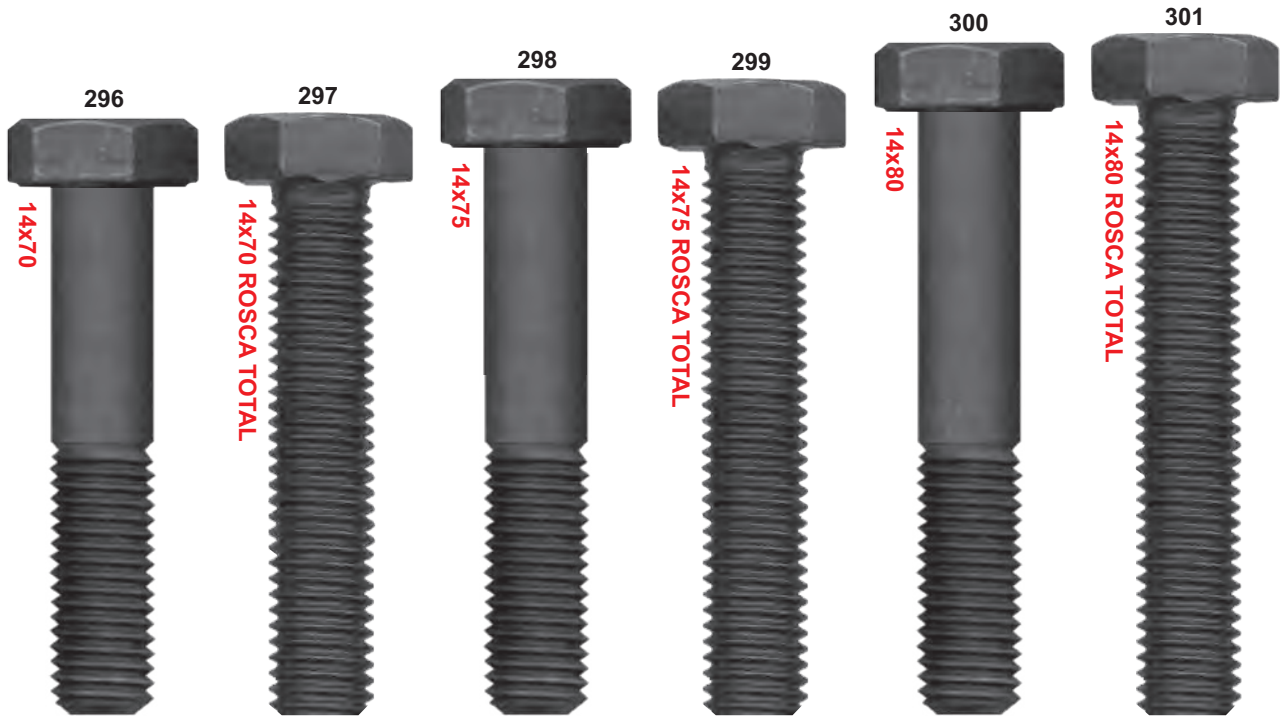

PARAFUSO SEXTAVADO AÇO 8.8 ROSCA GROSSA (MA) M-14

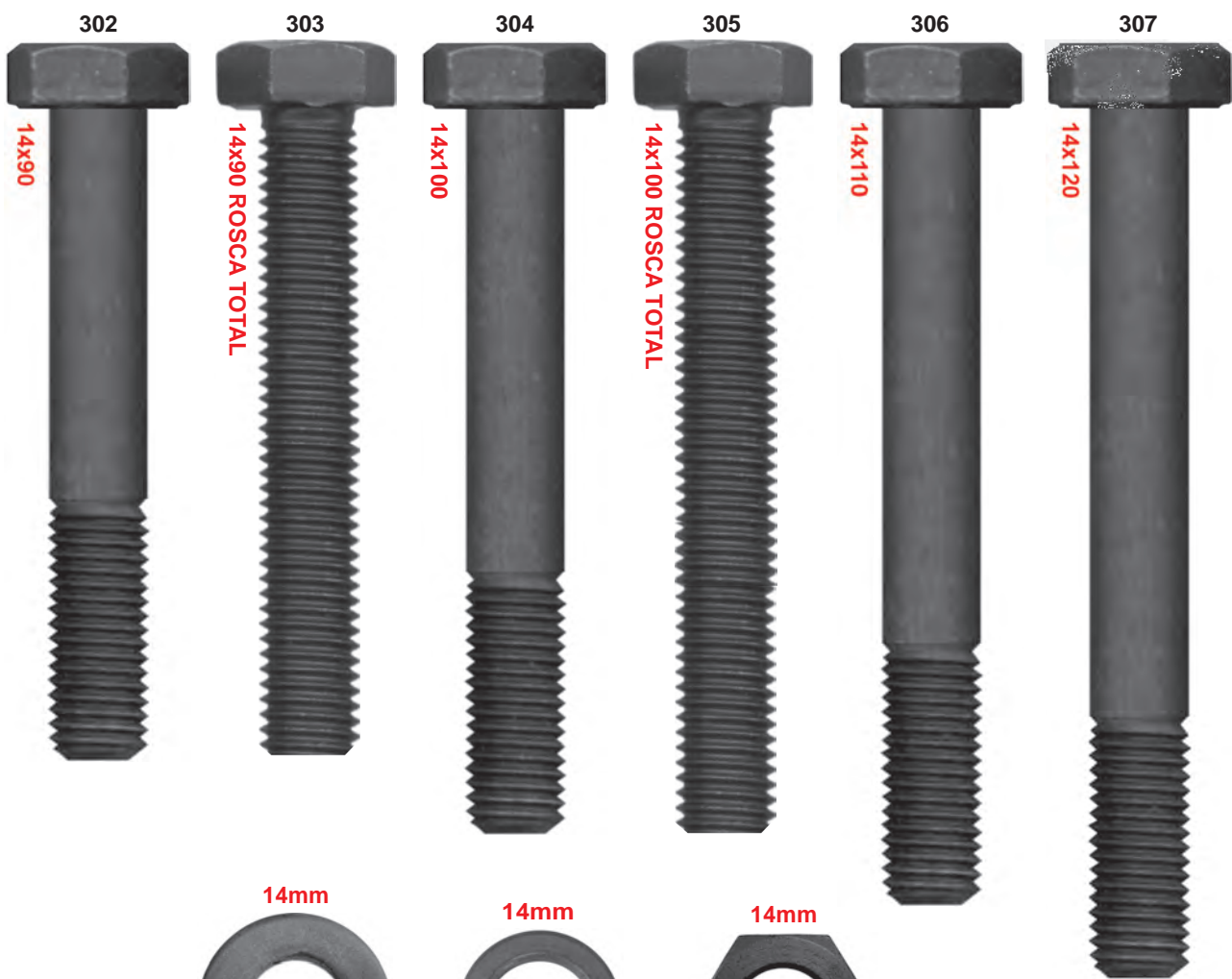

MEDIDA	FIO DE ROSCA	CHAVE
14MM	2,00	22MM



PARAFUSO SEXTAVADO AÇO 8.8 ROSCA GROSSA (MA) M-16



MEDIDA	FIO DE ROSCA	CHAVE
16MM	2,00	24MM

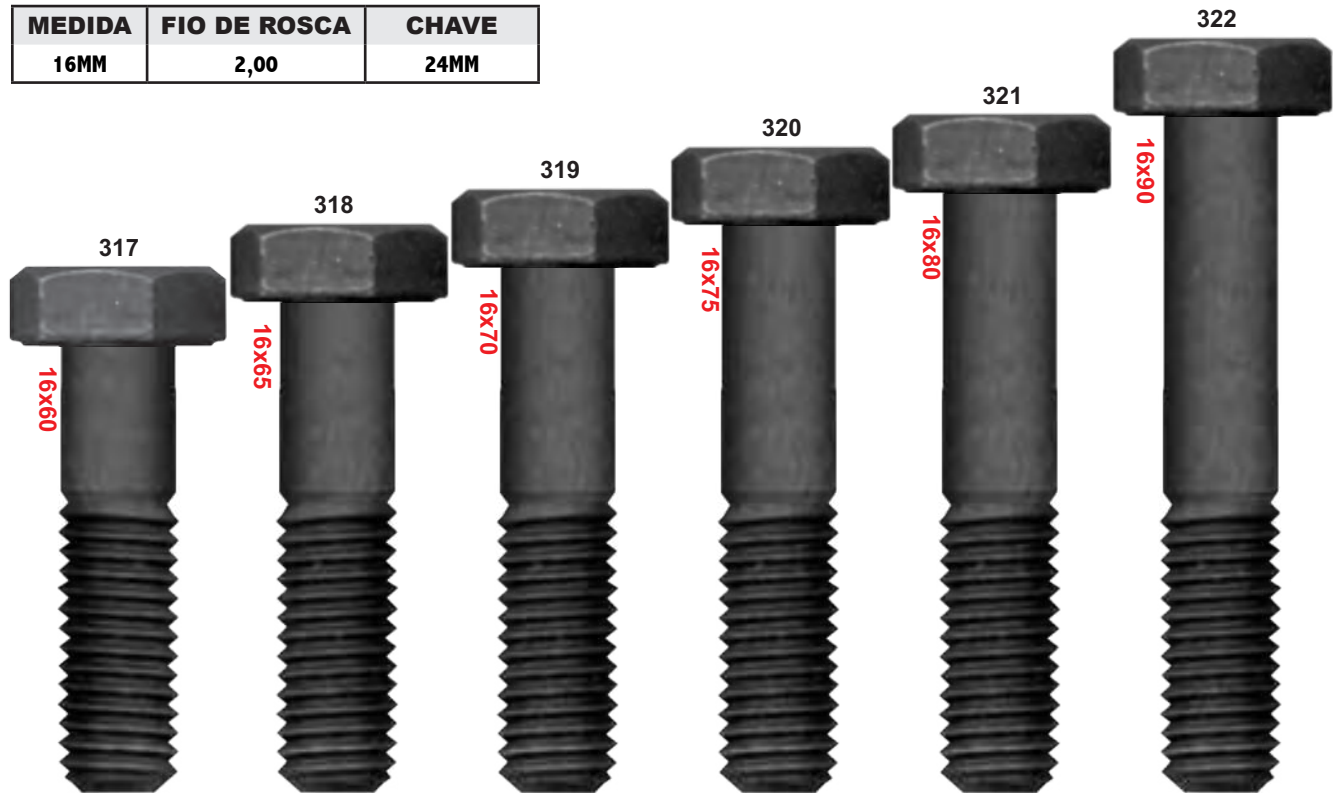

PARAFUSO SEXTAVADO AÇO 8.8 ROSCA GROSSA (MA) M-16

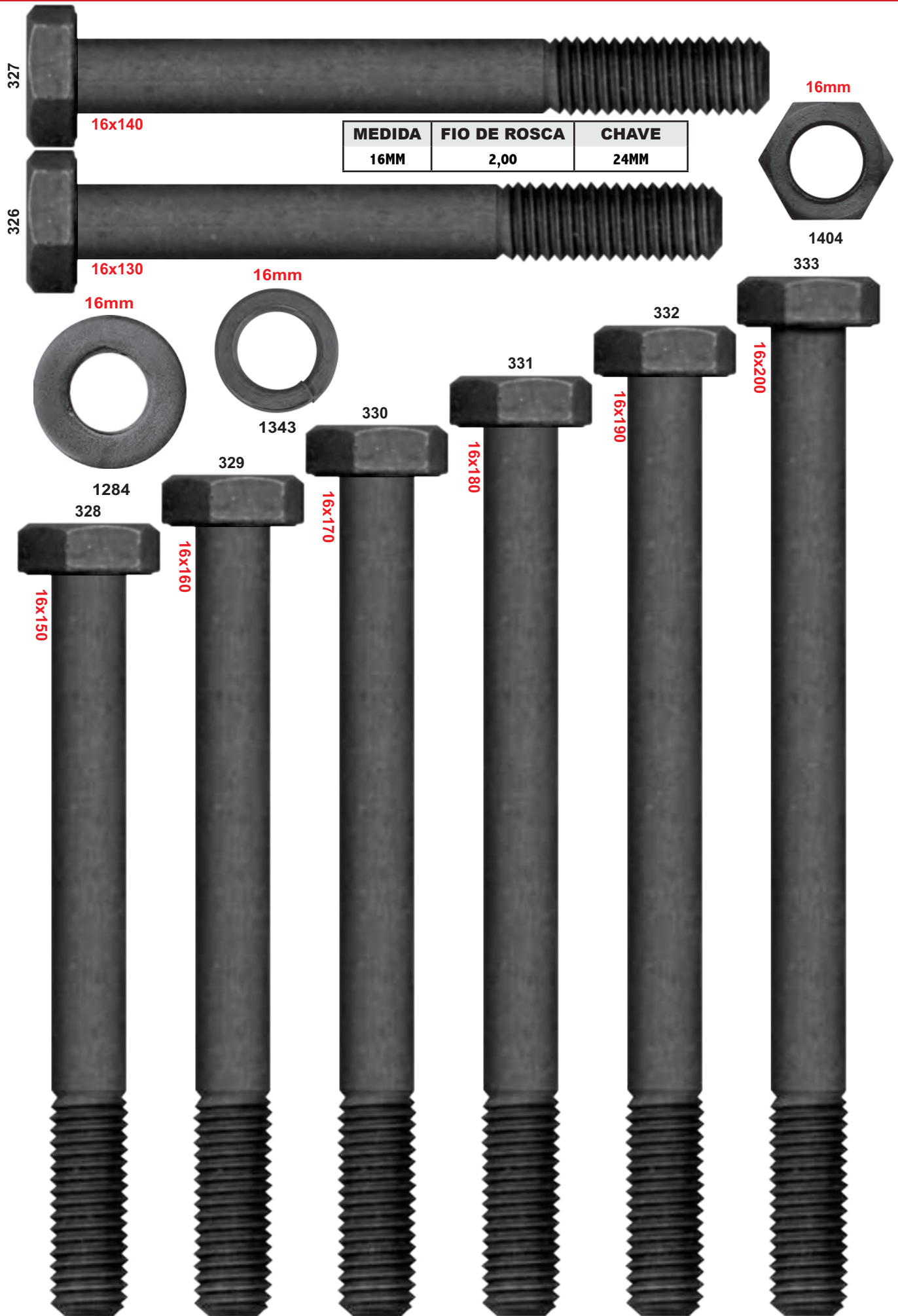

PARAFUSO SEXTAVADO AÇO 8.8 ROSCA GROSSA (MA) M-18

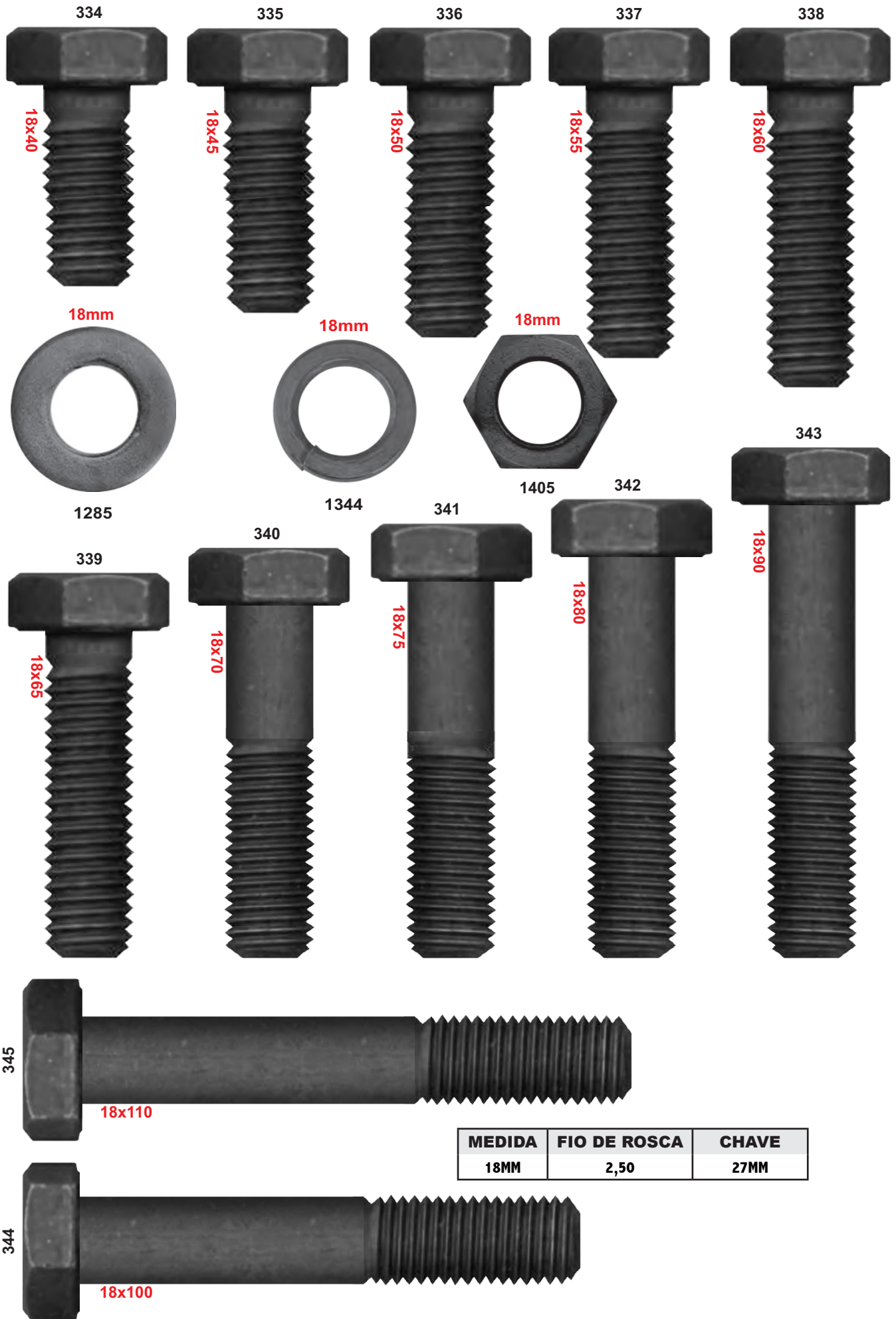

MEDIDA	FIO DE ROSCA	CHAVE
18MM	2,50	27MM



PARAFUSO SEXTAVADO AÇO 8.8 ROSCA GROSSA (MA) M-18



MEDIDA	FIO DE ROSCA	CHAVE
18MM	2,50	27MM

346

347

348

349

18x120

18x130

18x140

18x150

5821
18mm

18mm
1405

18mm
1344

18x160

18x170

18x180

18x190

18x200

350

351

352

353

354

PARAFUSO SEXTAVADO AÇO 8.8 ROSCA GROSSA (MA) M-20

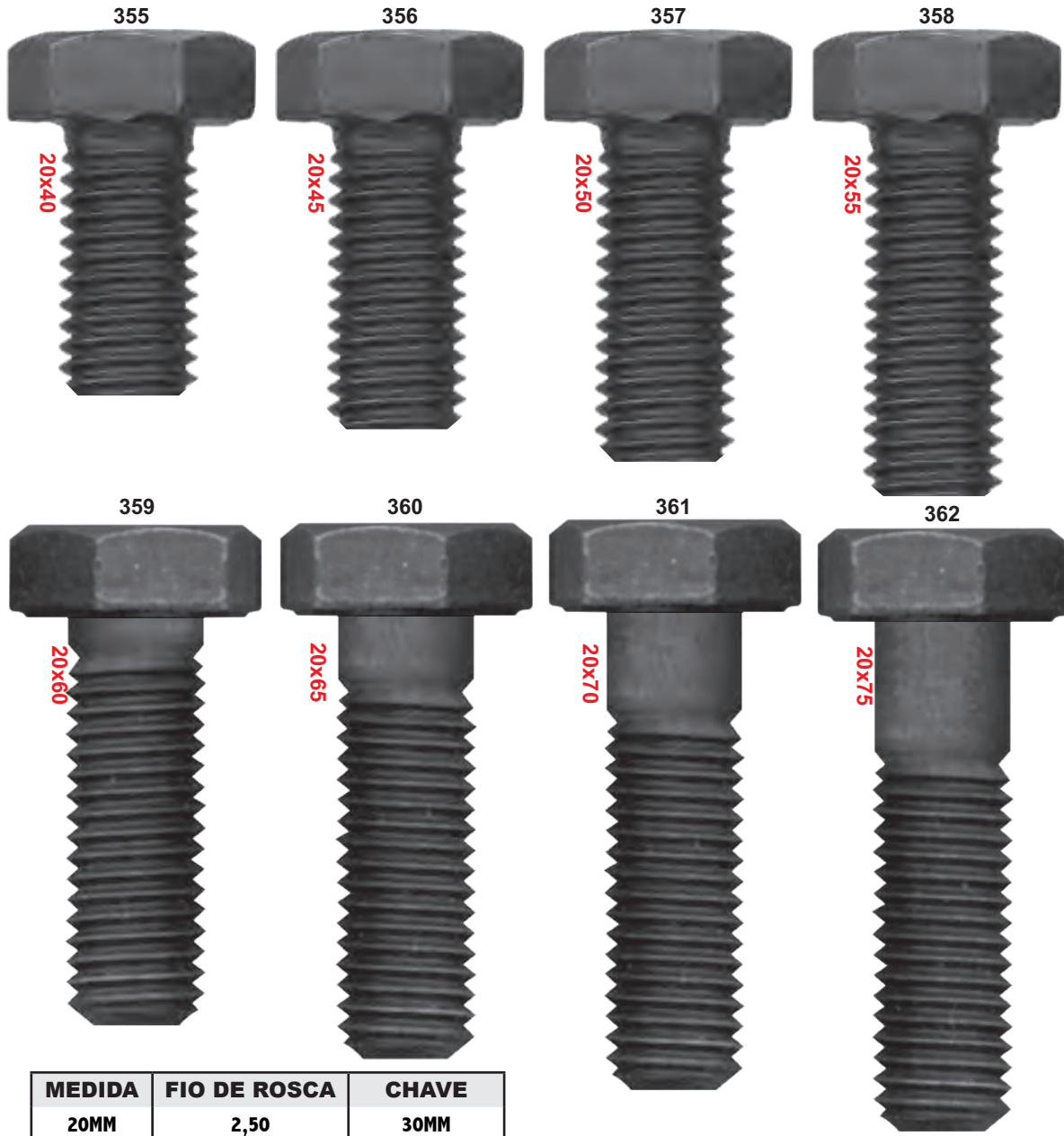

MEDIDA	FIO DE ROSCA	CHAVE
20MM	2,50	30MM

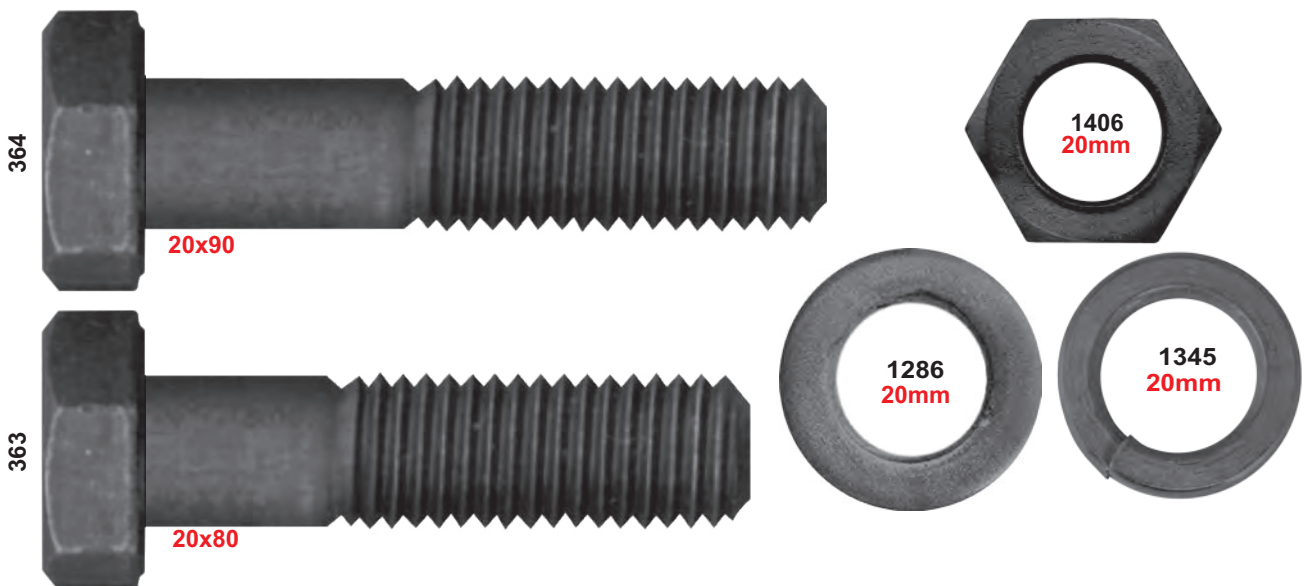

0
1
2
3
4
5
6
7
8
9
10
11
12
13
14
15
16
17
18
19
20
21
22
23
24
25
26
27

PARAFUSO SEXTAVADO AÇO 8.8 ROSCA GROSSA (MA) M-20



MEDIDA	FIO DE ROSCA	CHAVE
20MM	2,50	30MM

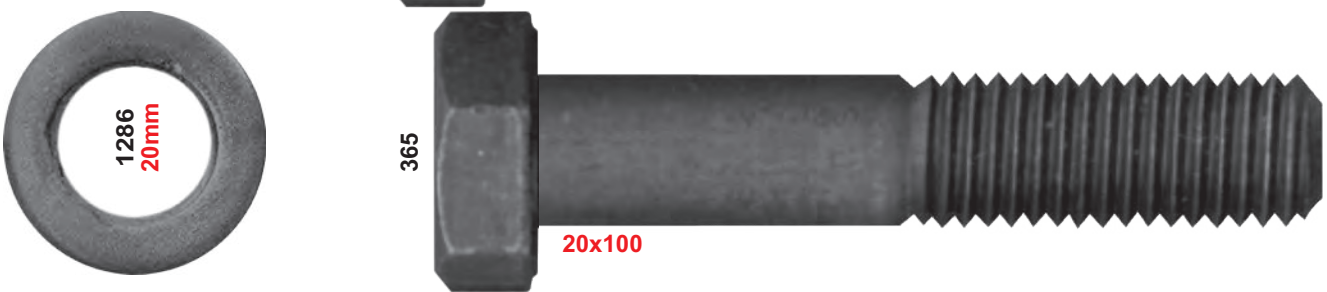
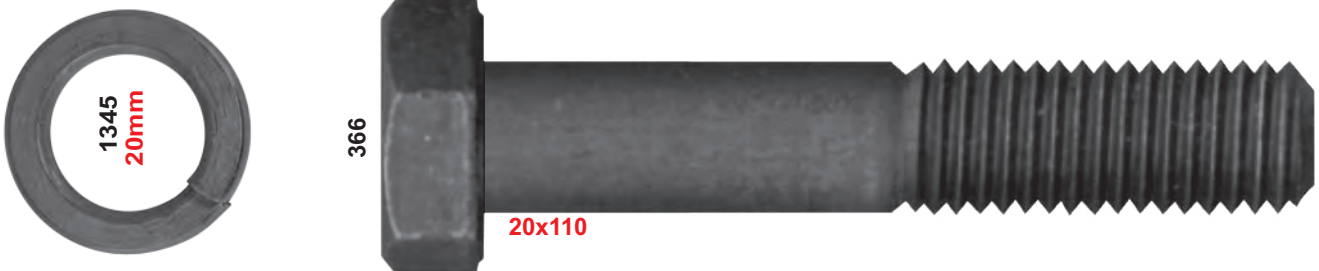
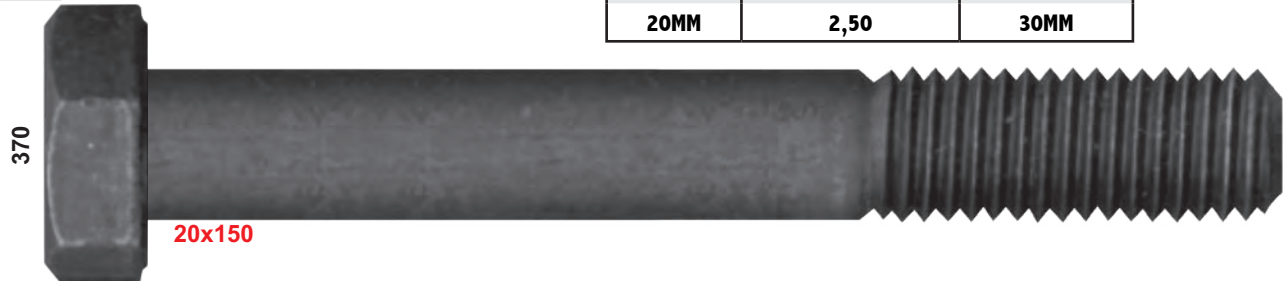

PARAFUSO SEXTAVADO AÇO 8.8 ROSCA GROSSA (MA) M-20



MEDIDA	FIO DE ROSCA	CHAVE
20MM	2,50	30MM



PARAFUSO SEXTAVADO AÇO 8.8 ROSCA GROSSA (MA) M-22

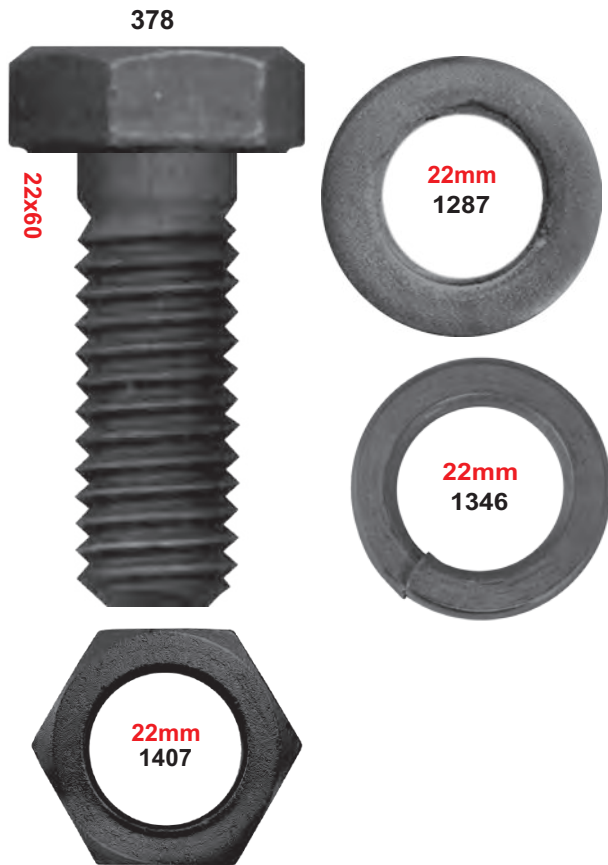

CODIGO	MEDIDA	ROSCA	CHAVE
376	M-22X50	2,50 TOTAL	32MM
377	M-22X55	2,50 TOTAL	32MM
378	M-22X60	2,50 TOTAL	32MM
379	M-22X65	2,50 TOTAL	32MM
380	M-22X70	2,50 TOTAL	32MM
381	M-22X75	2,50 TOTAL	32MM
382	M-22X80	2,50 TOTAL	32MM
383	M-22X90	2,50 PARCIAL	32MM
384	M-22X100	2,50 PARCIAL	32MM
385	M-22X110	2,50 PARCIAL	32MM
386	M-22X120	2,50 PARCIAL	32MM
387	M-22X130	2,50 PARCIAL	32MM
388	M-22X140	2,50 PARCIAL	32MM
389	M-22X150	2,50 PARCIAL	32MM
390	M-22X160	2,50 PARCIAL	32MM
391	M-22X170	2,50 PARCIAL	32MM
392	M-22X180	2,50 PARCIAL	32MM
393	M-22X190	2,50 PARCIAL	32MM
394	M-22X200	2,50 PARCIAL	32MM

PARAFUSO SEXTAVADO AÇO 8.8 ROSCA GROSSA (MA) M-24

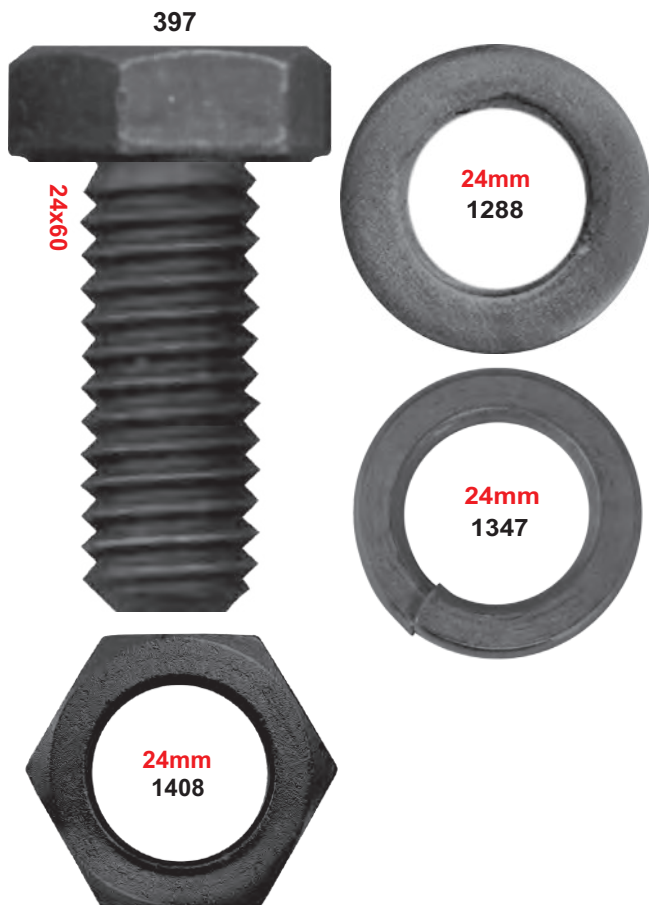

CODIGO	MEDIDA	ROSCA	CHAVE
395	M-24X50	3,00 TOTAL	36MM
396	M-24X55	3,00 TOTAL	36MM
397	M-24X60	3,00 TOTAL	36MM
398	M-24X65	3,00 TOTAL	36MM
399	M-24X70	3,00 TOTAL	36MM
400	M-24X75	3,00 TOTAL	36MM
401	M-24X80	3,00 TOTAL	36MM
402	M-24X90	3,00 PARCIAL	36MM
403	M-24X100	3,00 PARCIAL	36MM
404	M-24X110	3,00 PARCIAL	36MM
405	M-24X120	3,00 PARCIAL	36MM
406	M-24X130	3,00 PARCIAL	36MM
407	M-24X140	3,00 PARCIAL	36MM
408	M-24X150	3,00 PARCIAL	36MM
409	M-24X160	3,00 PARCIAL	36MM
410	M-24X170	3,00 PARCIAL	36MM
411	M-24X180	3,00 PARCIAL	36MM
412	M-24X190	3,00 PARCIAL	36MM
413	M-24X200	3,00 PARCIAL	36MM

PARAFUSO SEXTAVADO AÇO 8.8 ROSCA GROSSA (MA) M-27

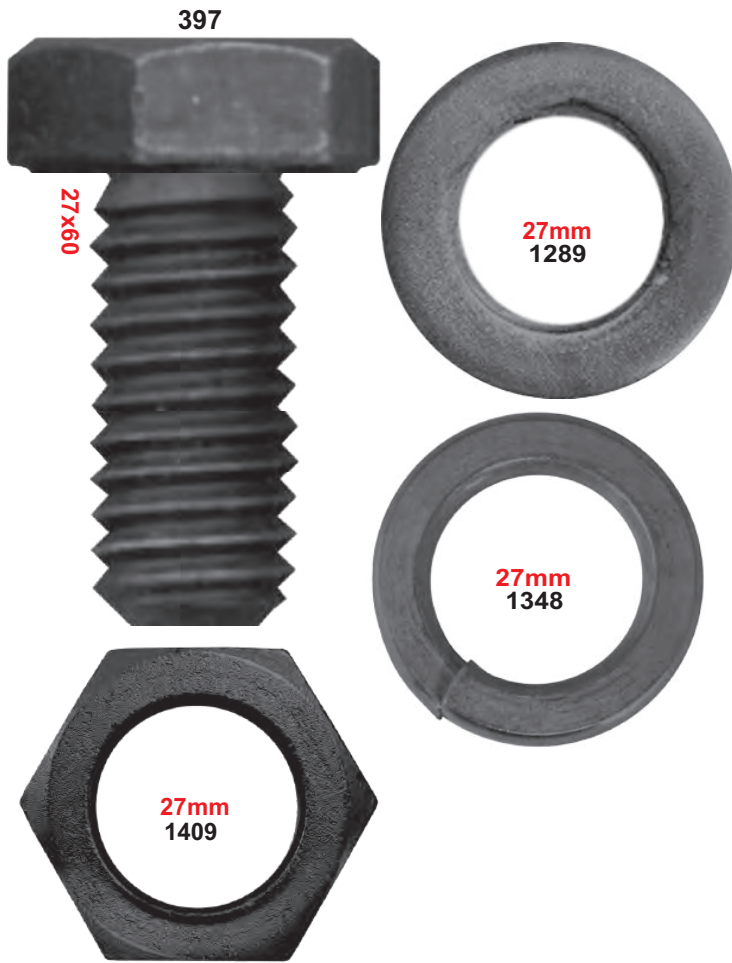

CODIGO	MEDIDA	ROSCA	CHAVE
414	M-27X50	3,00 TOTAL	41MM
415	M-27X55	3,00 TOTAL	41MM
416	M-27X60	3,00 TOTAL	41MM
417	M-27X65	3,00 TOTAL	41MM
418	M-27X70	3,00 TOTAL	41MM
419	M-27X75	3,00 TOTAL	41MM
420	M-27X80	3,00 TOTAL	41MM
421	M-27X90	3,00 PARCIAL	41MM
422	M-27X100	3,00 PARCIAL	41MM
423	M-27X110	3,00 PARCIAL	41MM
424	M-27X120	3,00 PARCIAL	41MM
425	M-27X130	3,00 PARCIAL	41MM
426	M-27X140	3,00 PARCIAL	41MM
427	M-27X150	3,00 PARCIAL	41MM
428	M-27X160	3,00 PARCIAL	41MM
429	M-27X170	3,00 PARCIAL	41MM
430	M-27X180	3,00 PARCIAL	41MM
431	M-27X190	3,00 PARCIAL	41MM
432	M-27X200	3,00 PARCIAL	41MM
433	M-27X210	3,00 PARCIAL	41MM
434	M-27X220	3,00 PARCIAL	41MM
435	M-27X230	3,00 PARCIAL	41MM
436	M-27X240	3,00 PARCIAL	41MM
437	M-27X250	3,00 PARCIAL	41MM

PARAFUSO SEXTAVADO AÇO 8.8 ROSCA GROSSA (MA) M-30

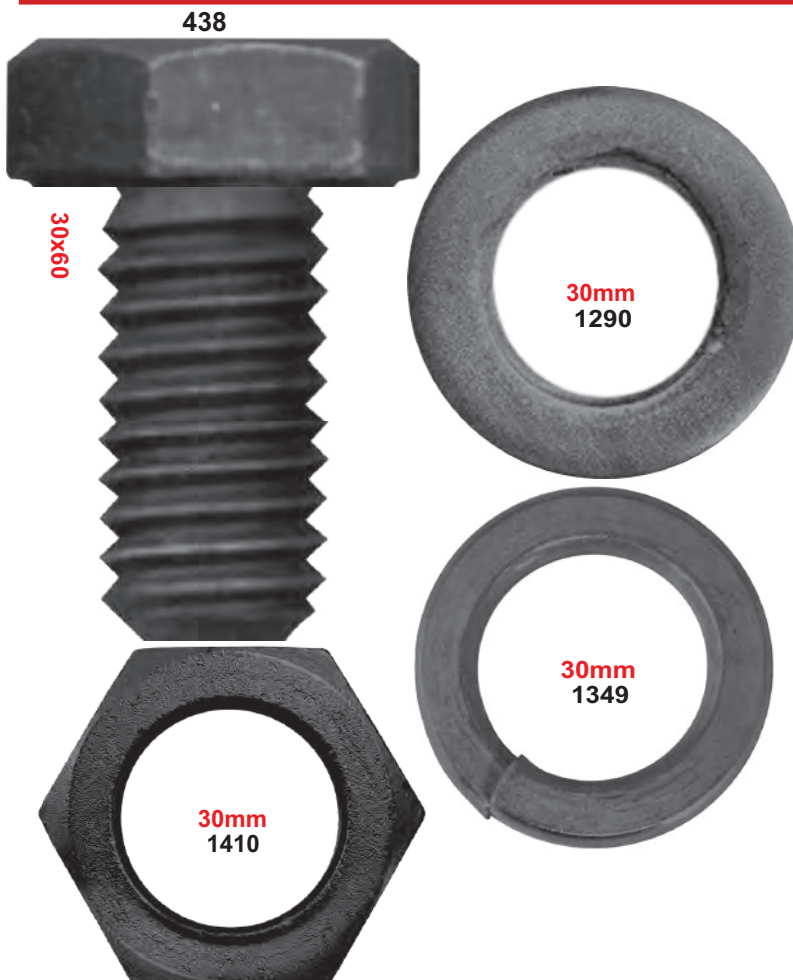

CODIGO	MEDIDA	ROSCA	CHAVE
438	M-30X60	3,50 TOTAL	46MM
439	M-30X65	3,50 TOTAL	46MM
440	M-30X70	3,50 TOTAL	46MM
441	M-30X75	3,50 TOTAL	46MM
442	M-30X80	3,50 TOTAL	46MM
443	M-30X90	3,50 PARCIAL	46MM
444	M-30X100	3,50 PARCIAL	46MM
445	M-30X110	3,50 PARCIAL	46MM
446	M-30X120	3,50 PARCIAL	46MM
447	M-30X130	3,50 PARCIAL	46MM
448	M-30X140	3,50 PARCIAL	46MM
449	M-30X150	3,50 PARCIAL	46MM
450	M-30X160	3,50 PARCIAL	46MM
451	M-30X170	3,50 PARCIAL	46MM
452	M-30X180	3,50 PARCIAL	46MM
453	M-30X190	3,50 PARCIAL	46MM
454	M-30X200	3,50 PARCIAL	46MM
455	M-30X210	3,50 PARCIAL	46MM
456	M-30X220	3,50 PARCIAL	46MM
457	M-30X230	3,50 PARCIAL	46MM
458	M-30X240	3,50 PARCIAL	46MM
459	M-30X250	3,00 PARCIAL	46MM
436	M-27X240	3,50 PARCIAL	46MM
437	M-27X250	3,50 PARCIAL	46MM

PARAFUSO SEXTAVADO AÇO 8.8 ROSCA FINA (MB) M-8

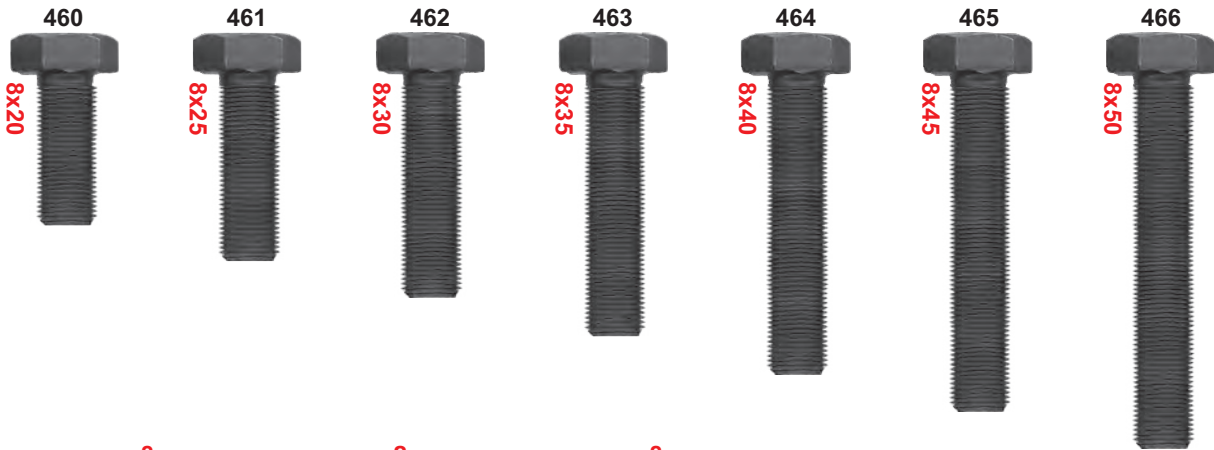

MEDIDA	FIO DE ROSCA	CHAVE
8MM	1,00	13MM



PARAFUSO SEXTAVADO AÇO 8.8 ROSCA FINA (MB) M-8

MEDIDA	FIO DE ROSCA	CHAVE
10MM	1,00	17MM

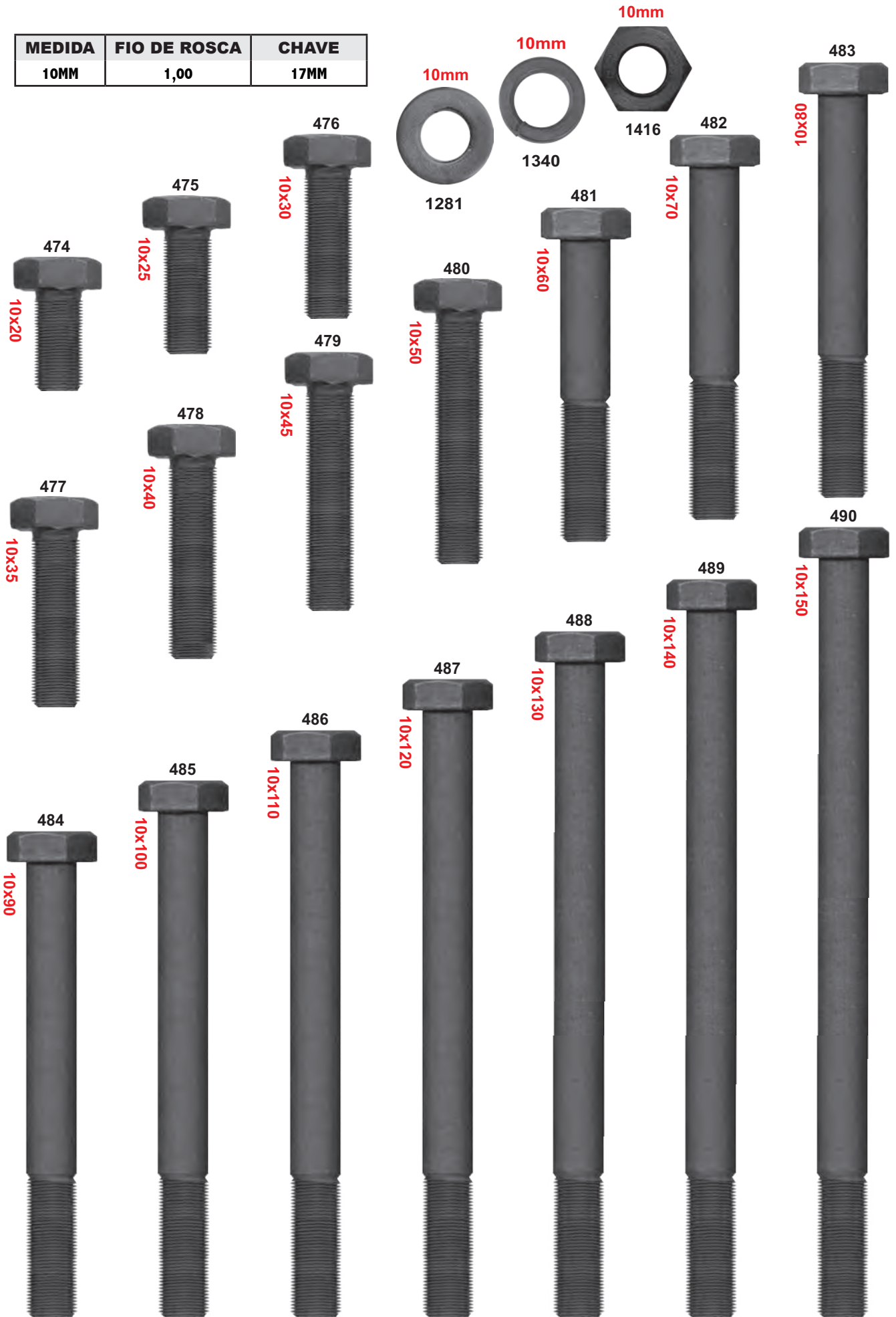

PARAFUSO SEXTAVADO AÇO 8.8 ROSCA FINA (MB) M-12



MEDIDA	FIO DE ROSCA	CHAVE
12MM	1,50	19MM

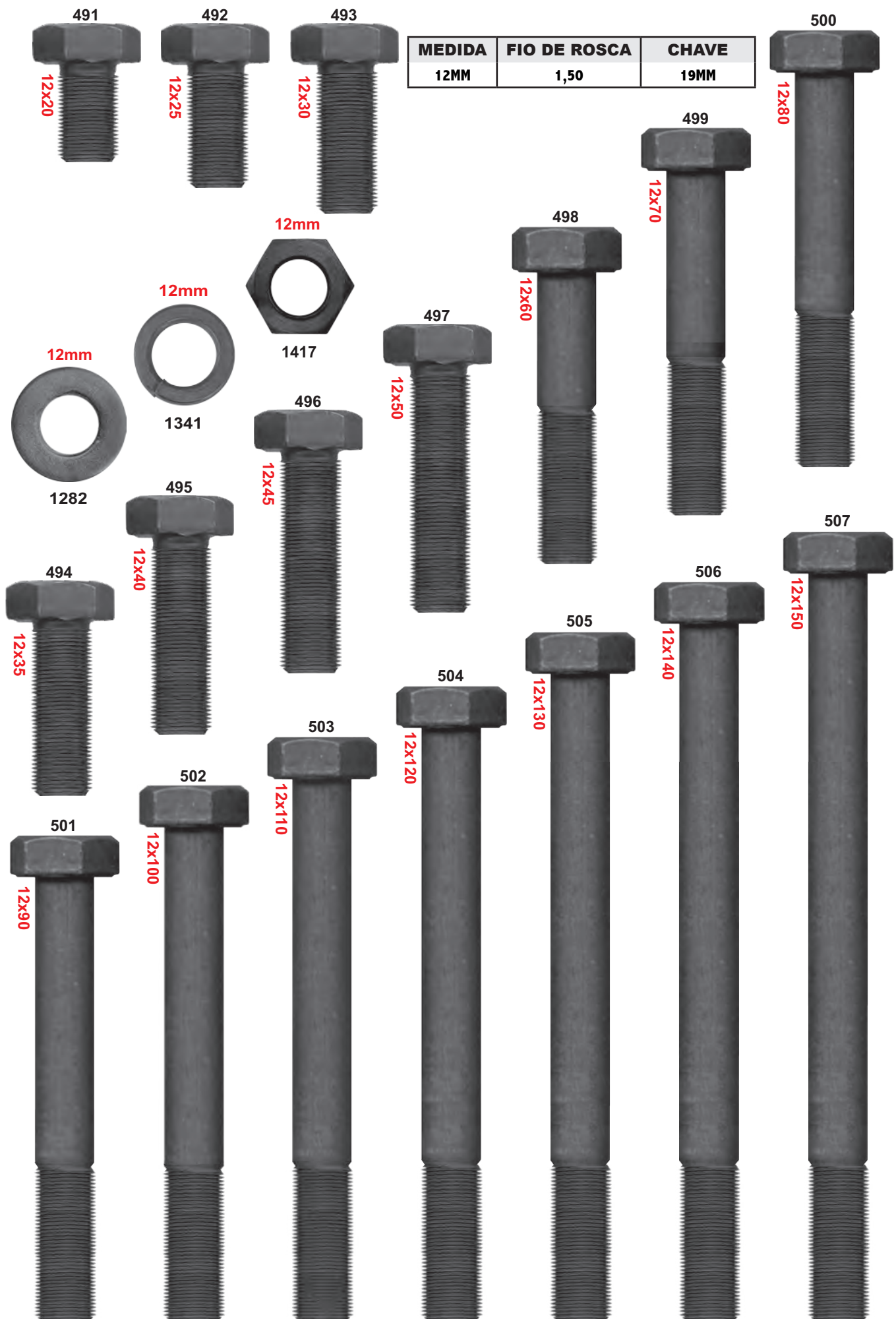

PARAFUSO SEXTAVADO AÇO 8.8 ROSCA FINA (MB) M-14

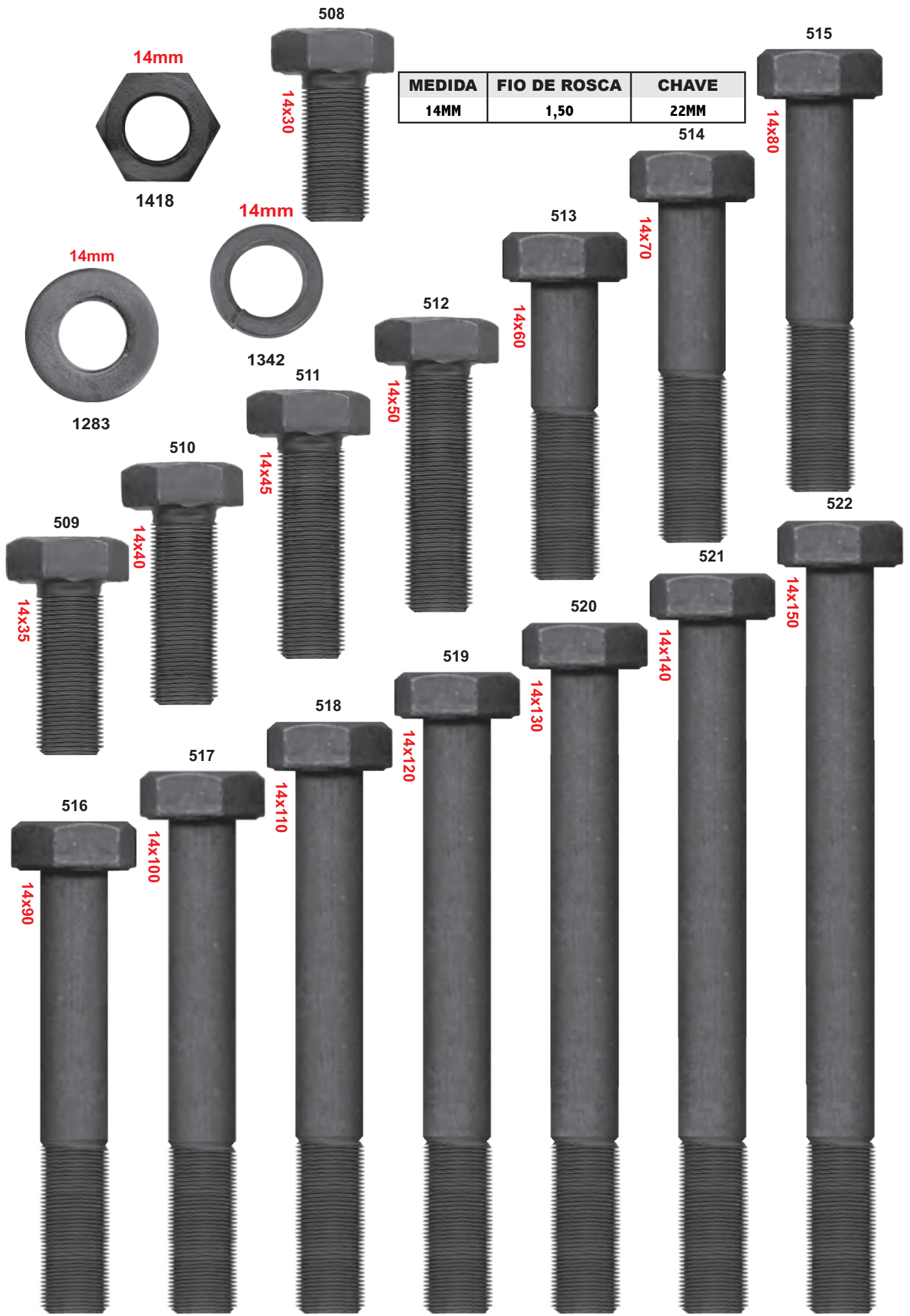

PARAFUSO SEXTAVADO AÇO 8.8 ROSCA FINA (MB) M-16

MEDIDA	FIO DE ROSCA	CHAVE
16MM	1,50	24MM

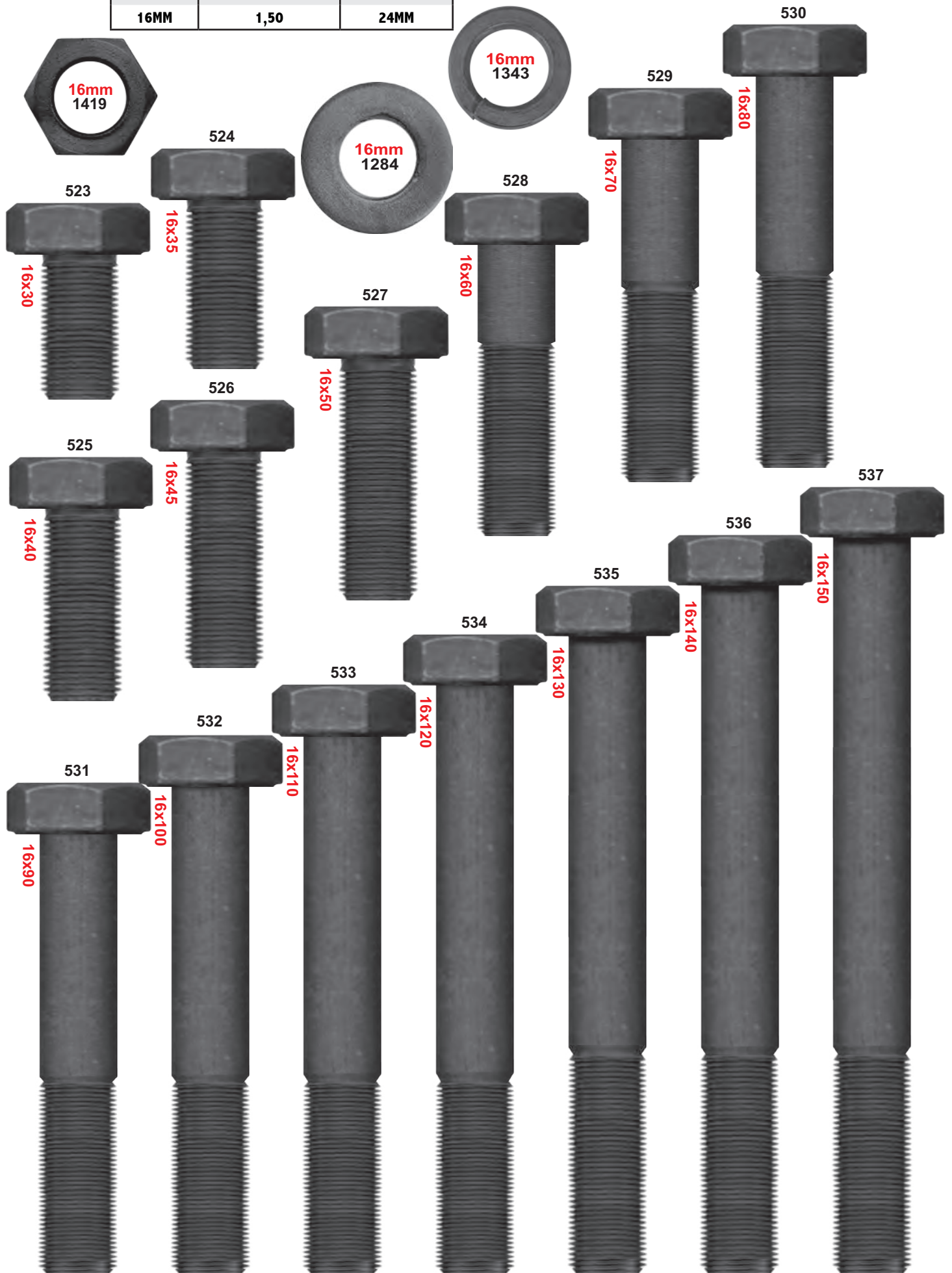

PARAFUSO SEXTAVADO AÇO 8.8 ROSCA FIAT (MB) M-10

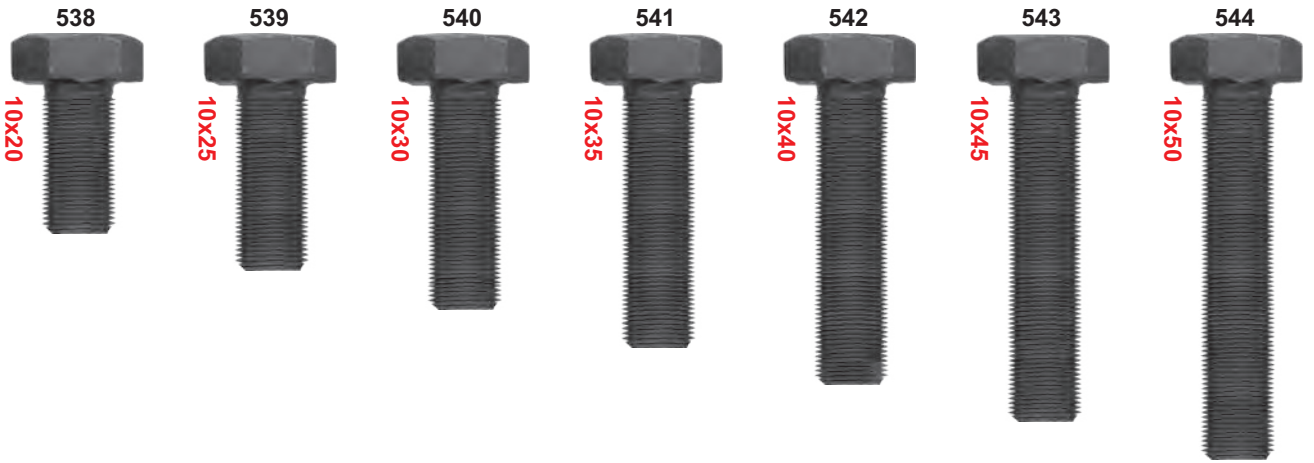

MEDIDA	FIO DE ROSCA	CHAVE
10MM	1,25	17MM

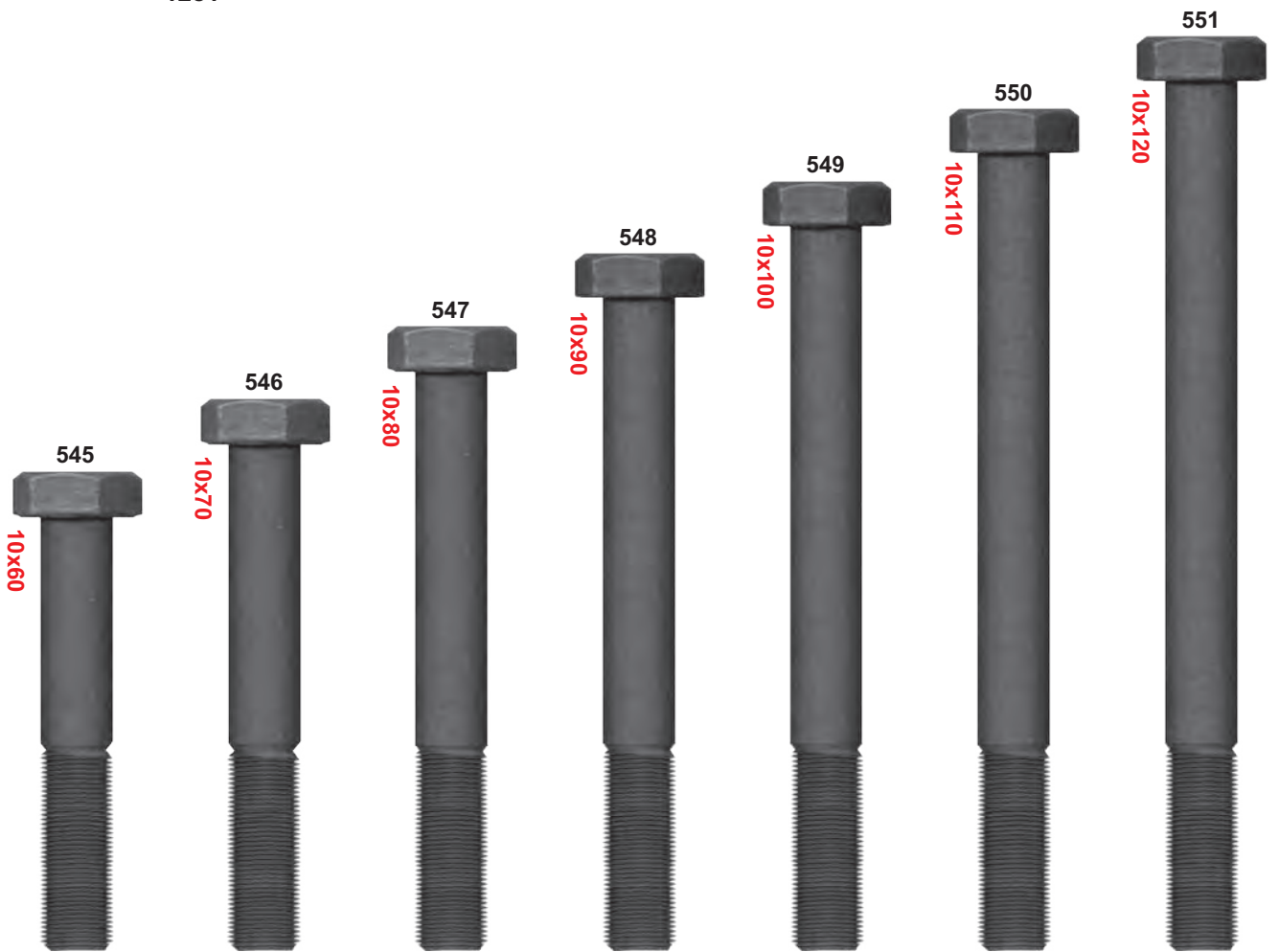

PARAFUSO SEXTAVADO AÇO 8.8 ROSCA FIAT (MB) M-12

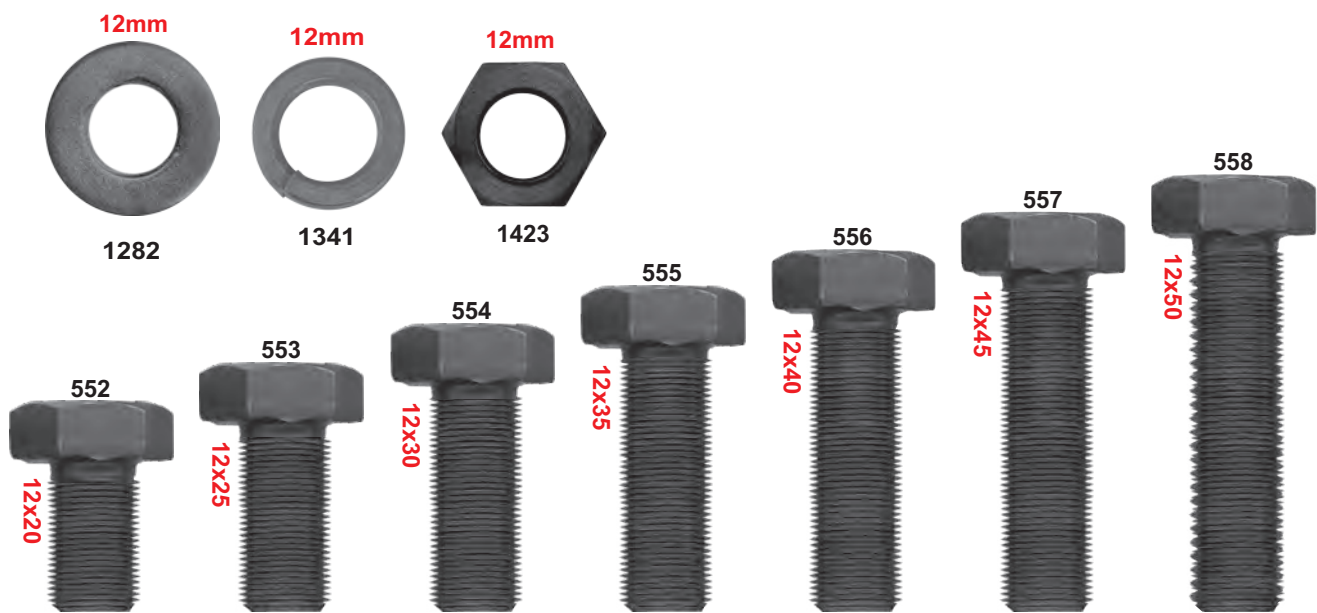

MEDIDA	FIO DE ROSCA	CHAVE
12MM	1,25	19MM

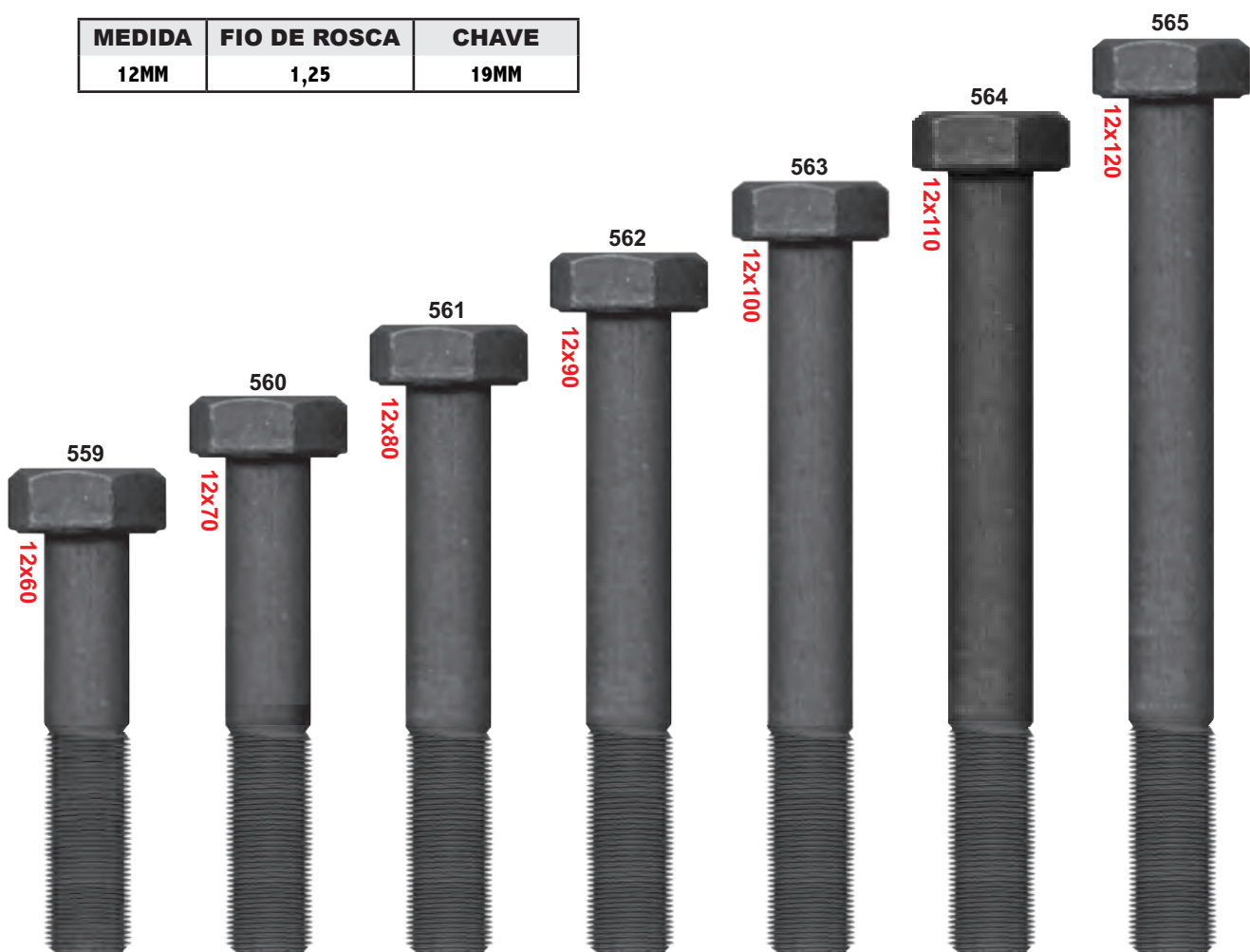

PARAFUSO SEXTAVADO AÇO 10.9 ROSCA GROSSA (MA) M-8

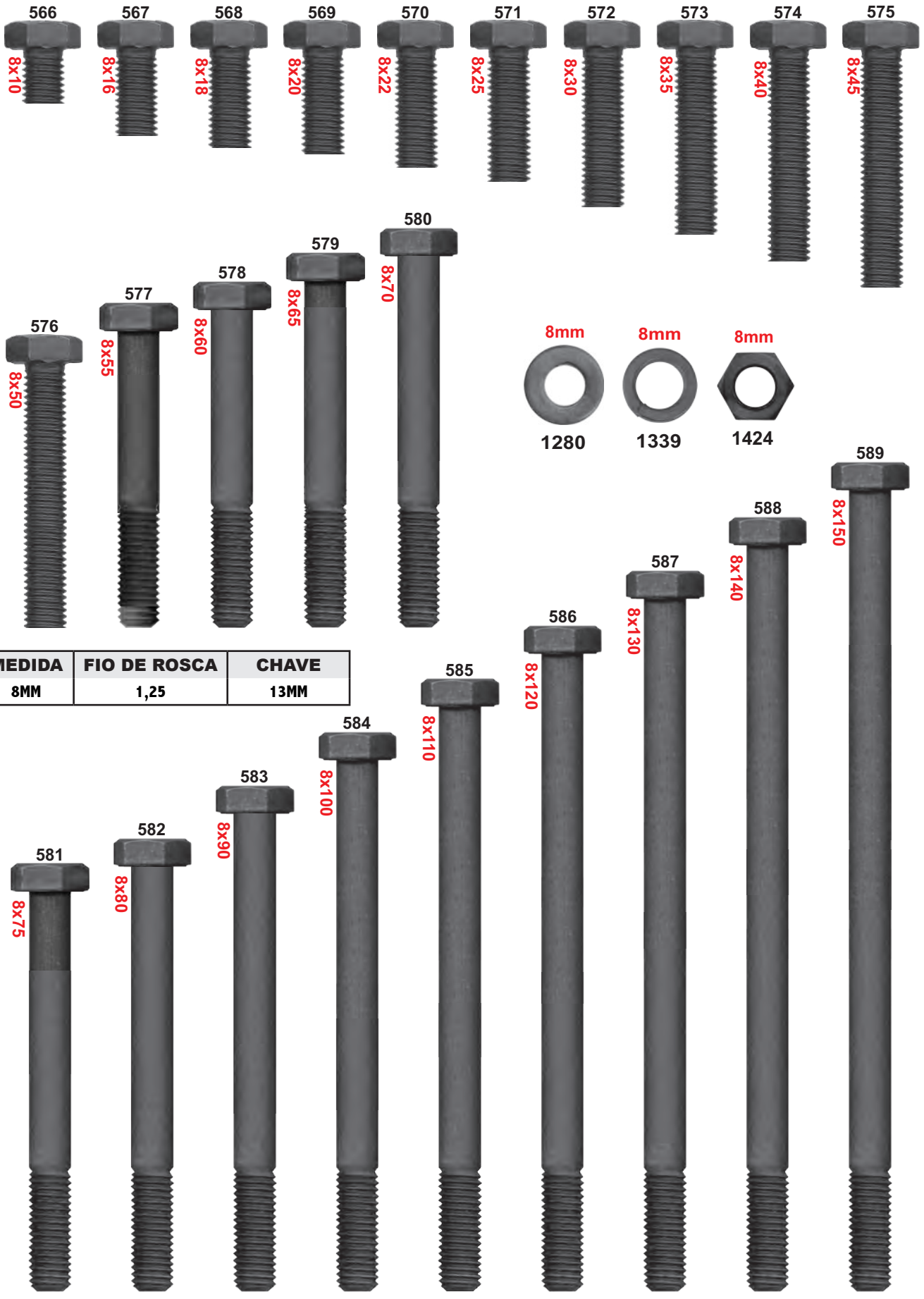

MEDIDA	FIO DE ROSCA	CHAVE
8MM	1,25	13MM



PARAFUSO SEXTAVADO AÇO 10.9 ROSCA GROSSA (MA) M-10

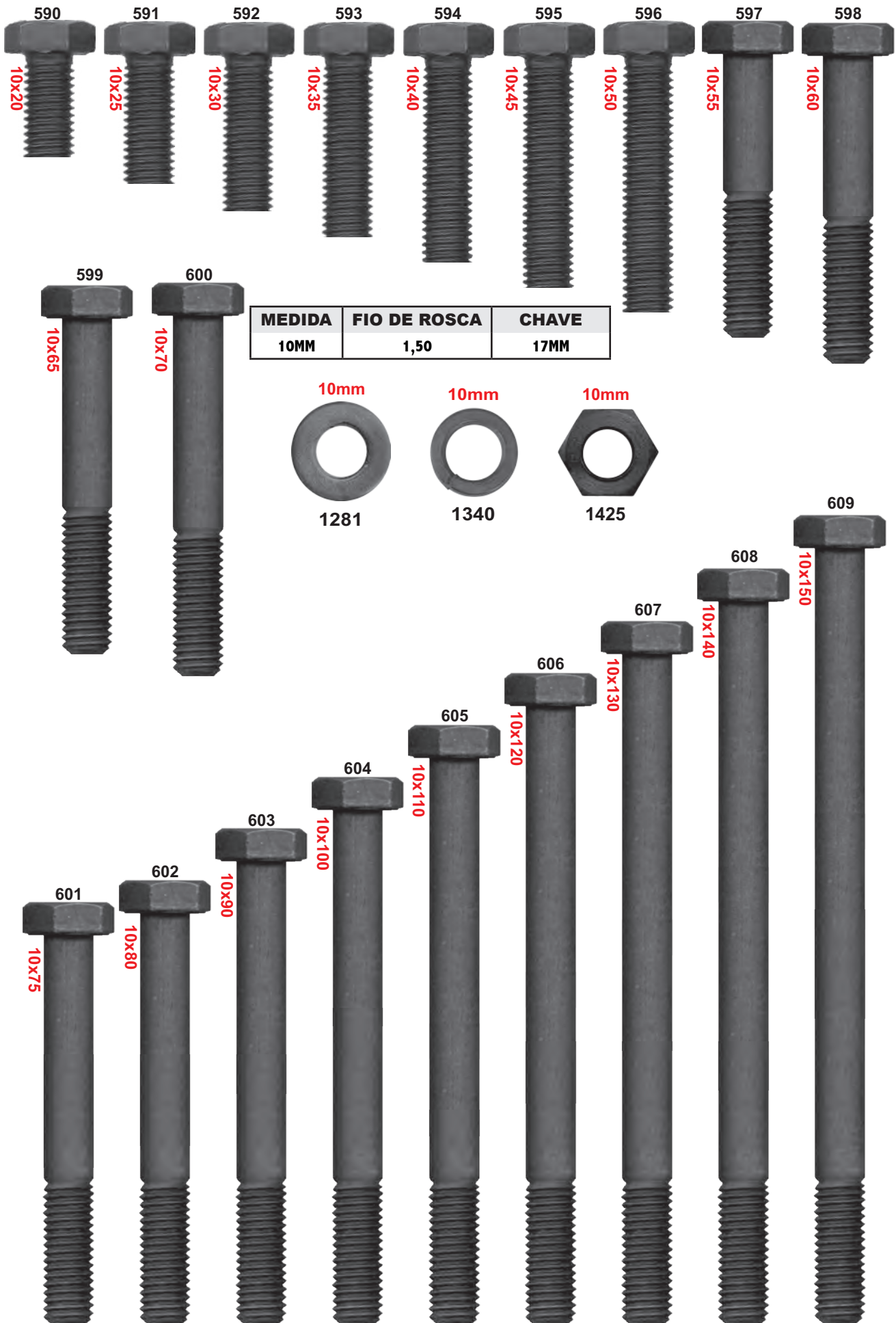

PARAFUSO SEXTAVADO AÇO 10.9 ROSCA FINA (MB) M-12

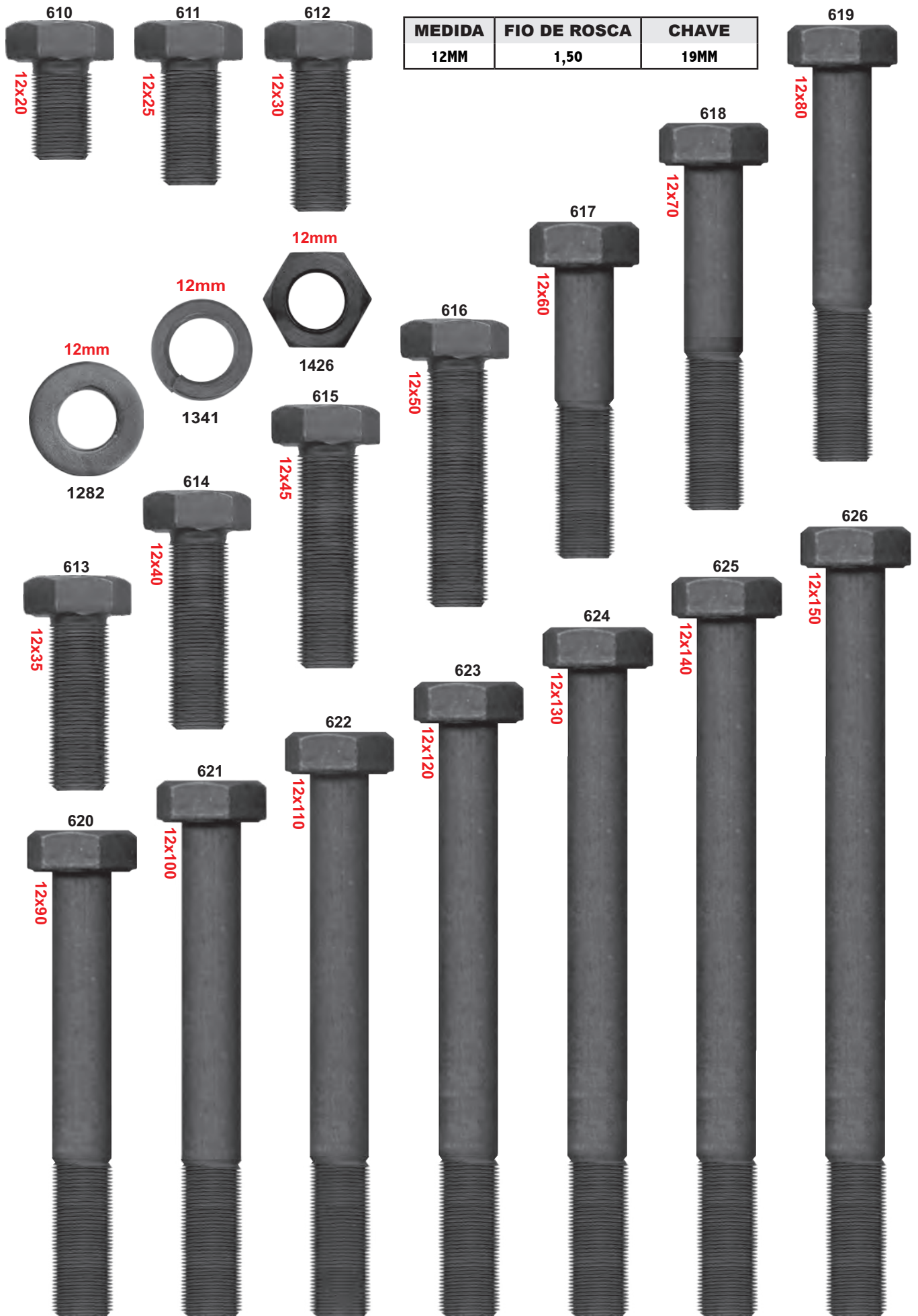

PARAFUSO SEXTAVADO AÇO 10.9 ROSCA FINA (MB) M-14

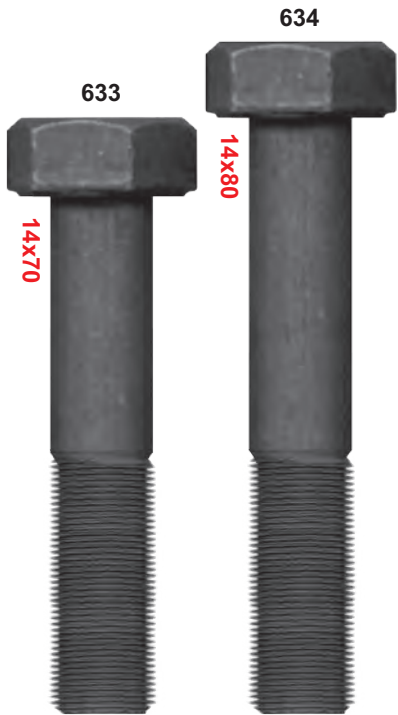
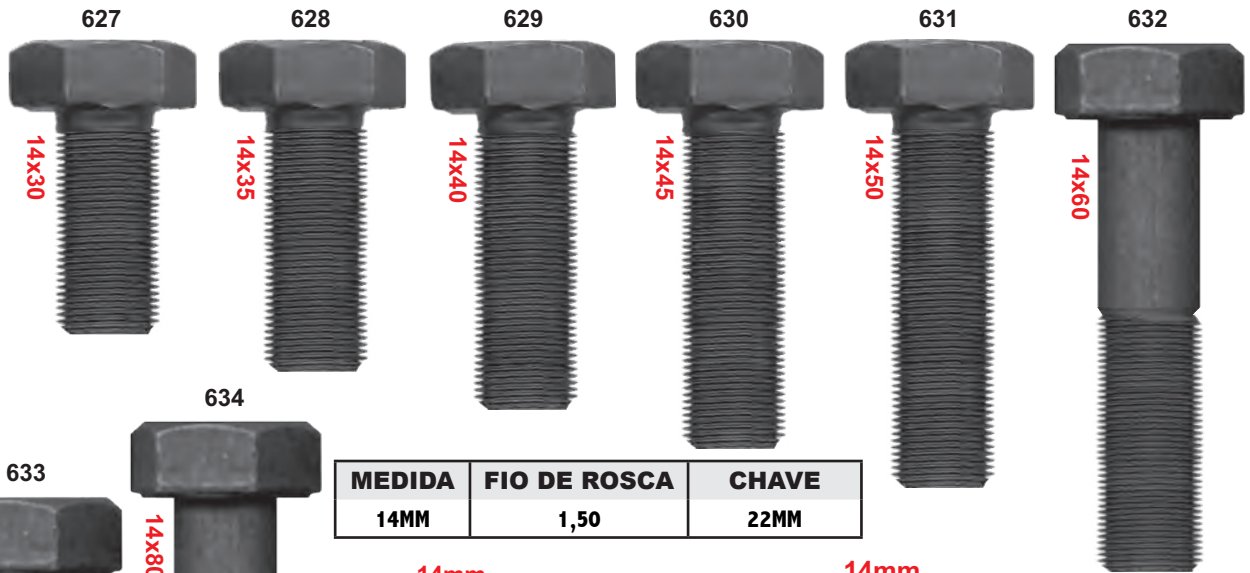

MEDIDA	FIO DE ROSCA	CHAVE
14MM	1,50	22MM

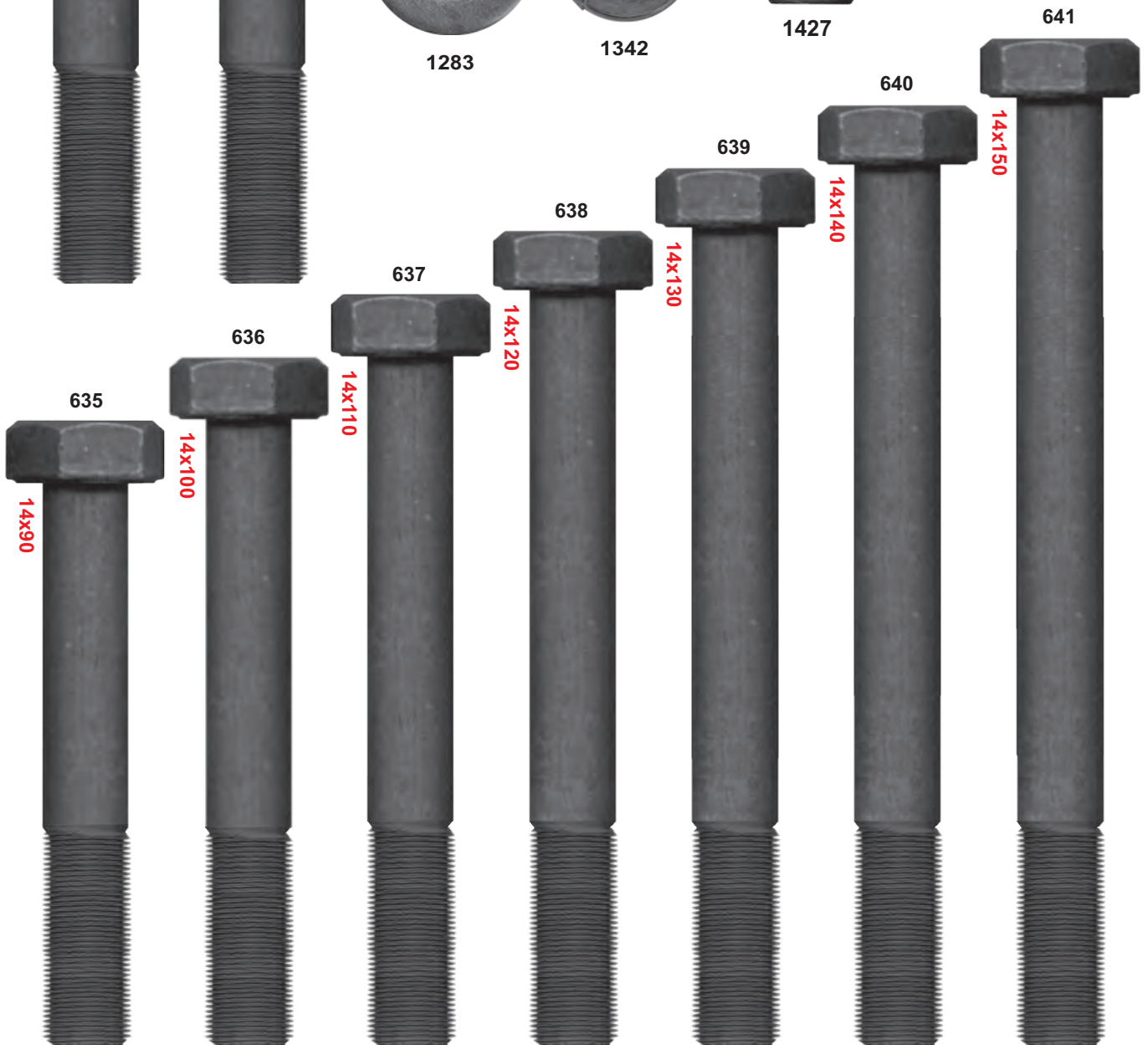

PARAFUSO SEXTAVADO AÇO 10.9 ROSCA FINA (MB) M-16

MEDIDA	FIO DE ROSCA	CHAVE
16MM	1,50	24MM

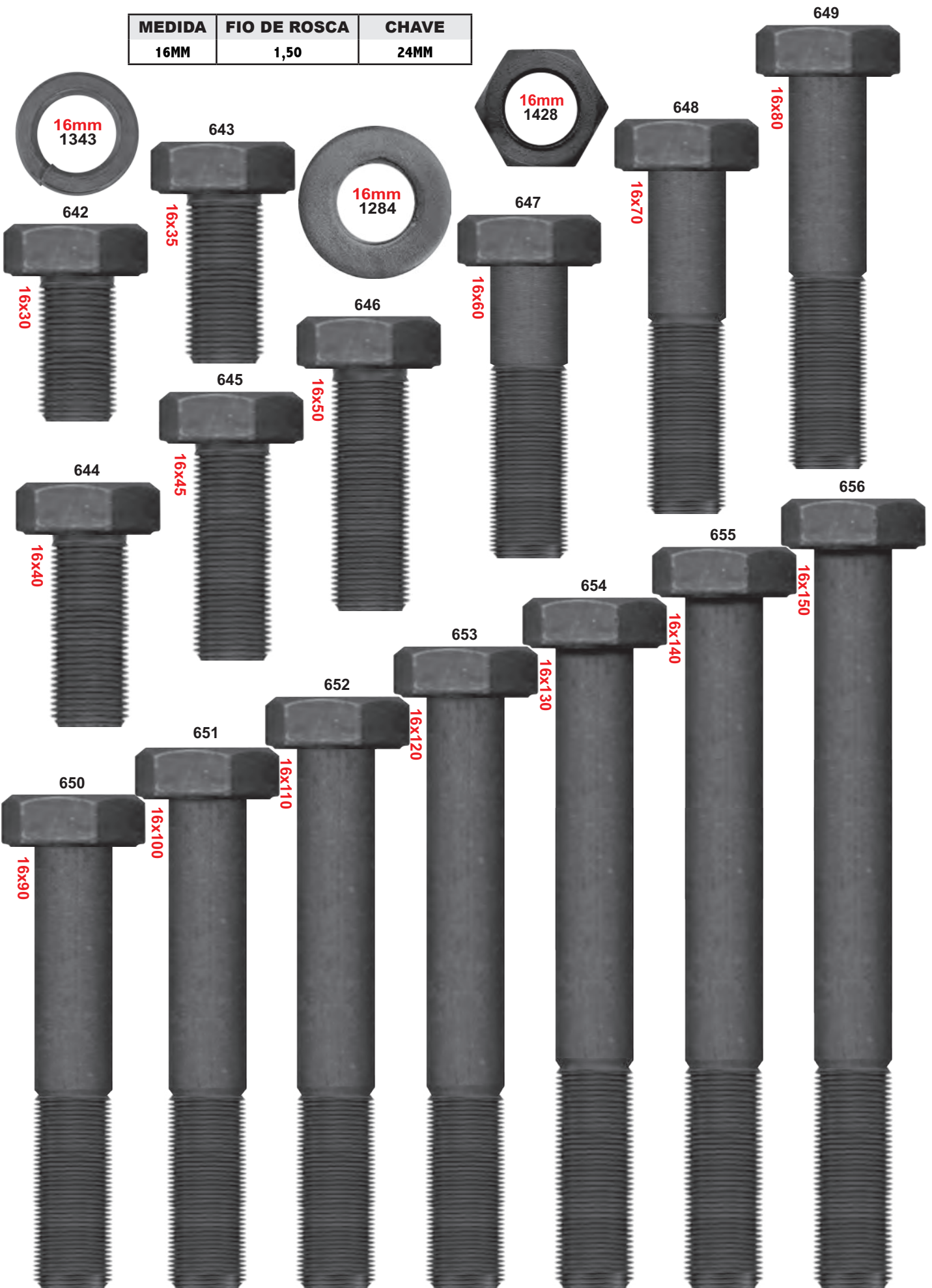

PARAFUSO SEXTAVADO AÇO 10.9 ROSCA FINA (MB) M-18

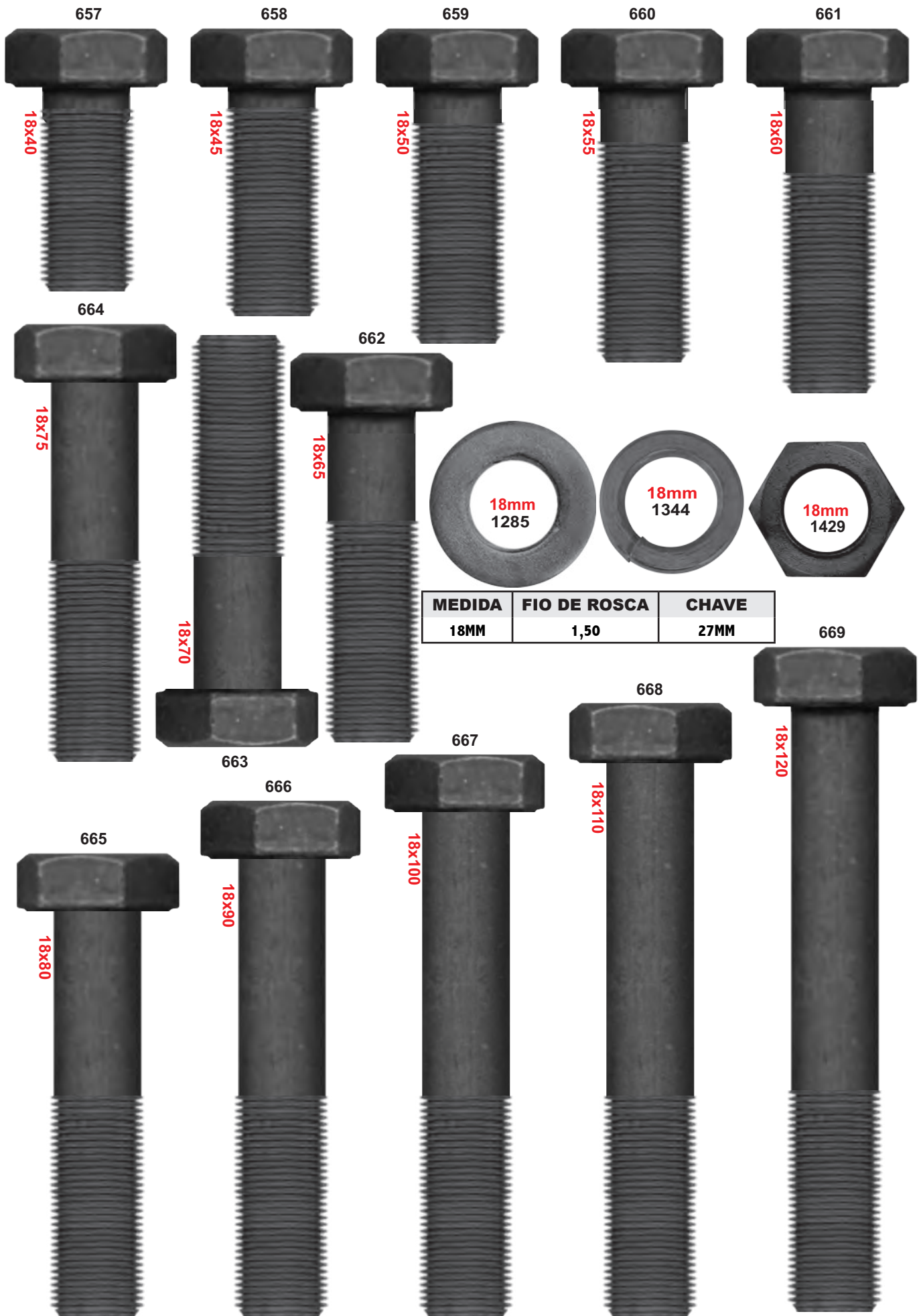

MEDIDA	FIO DE ROSCA	CHAVE
18MM	1,50	27MM

PARAFUSO SEXTAVADO AÇO 10.9 ROSCA FINA (MB) M-18



CHAVE	27MM
FIO DE ROSCA	1,50
MEDIDA	18MM

PARAFUSO SEXTAVADO AÇO 10.9 ROSCA FINA (MB) M-20

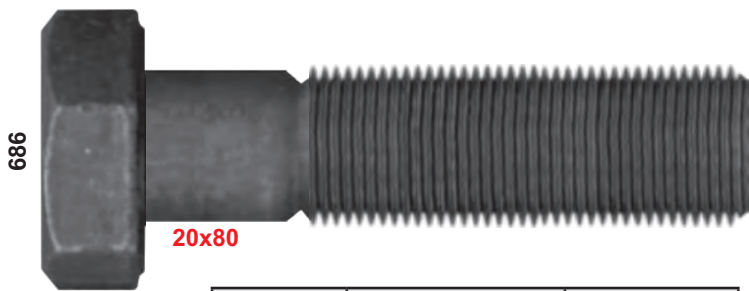

MEDIDA	FIO DE ROSCA	CHAVE
20MM	1,50	30MM

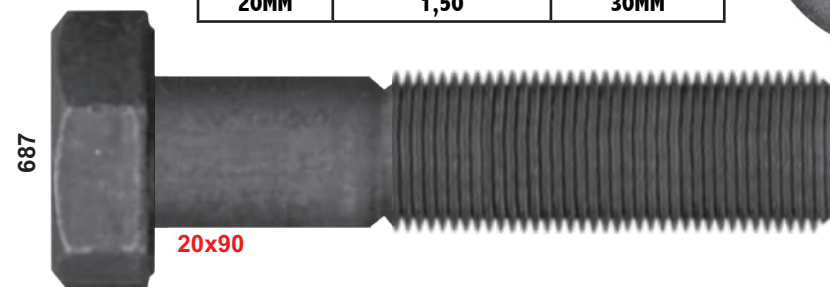

PARAFUSO SEXTAVADO AÇO 10.9 ROSCA FINA (MB) M-20

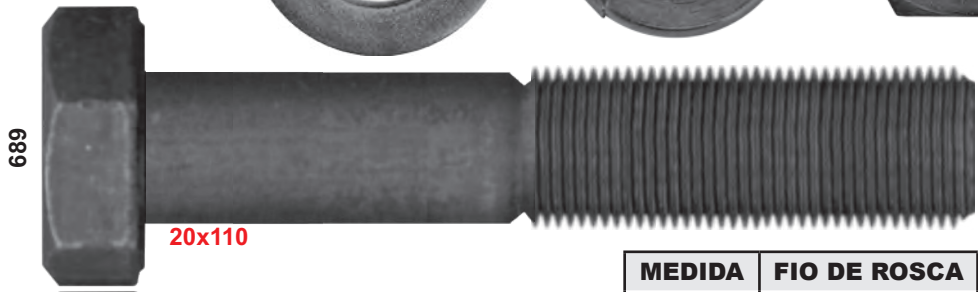

MEDIDA	FIO DE ROSCA	CHAVE
20MM	1,50	30MM

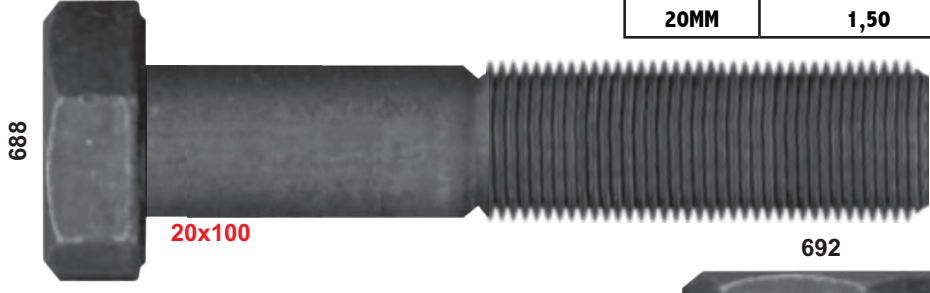

PARAFUSO SEXTAVADO AÇO 10.9 ROSCA FINA (MB) M-20



MEDIDA	FIO DE ROSCA	CHAVE
20MM	1,50	30MM

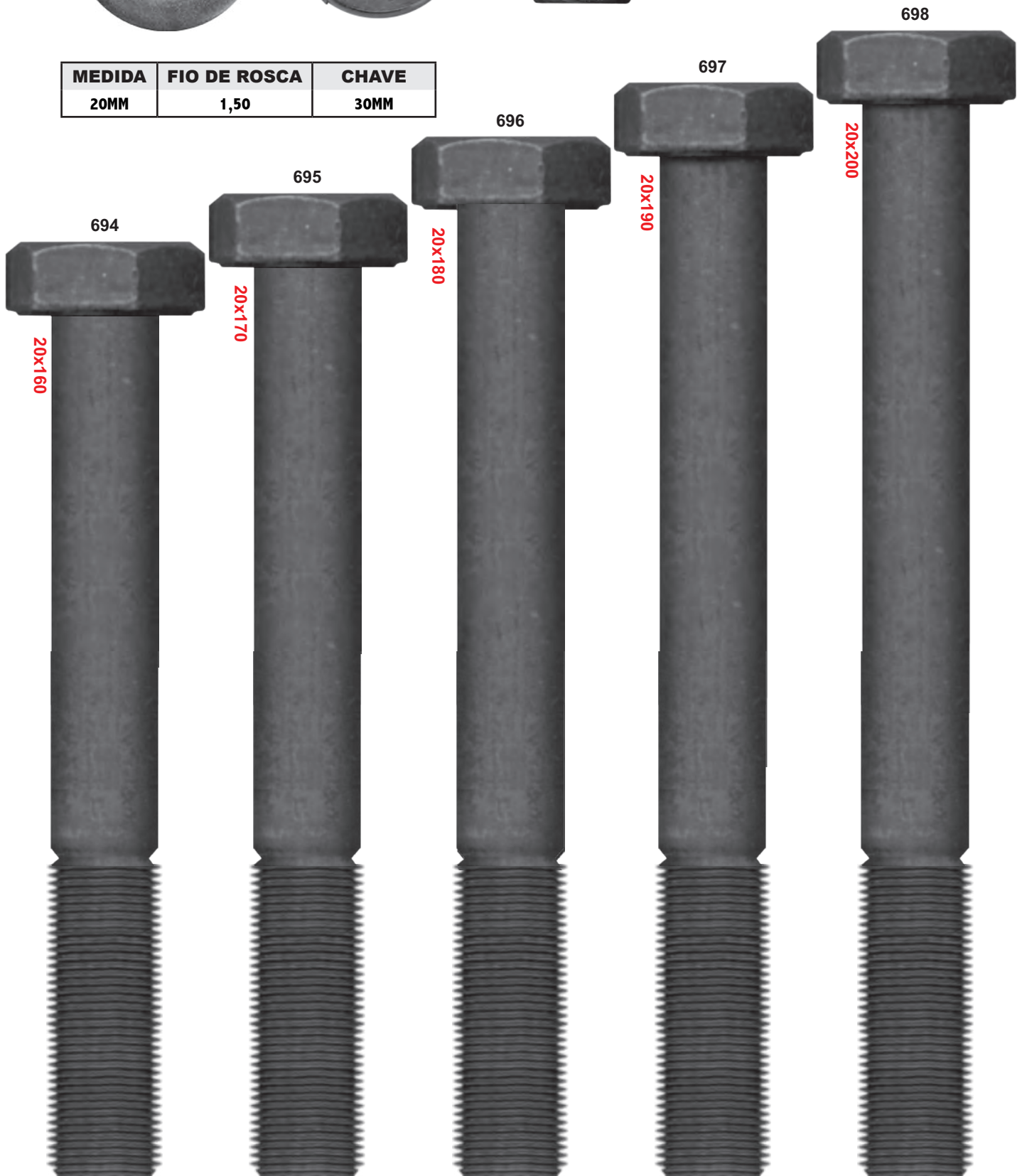

PARAFUSO SEXTAVADO AÇO GRAU 5 ROSCA GROSSA (UNC) 1/4" E 5/16"

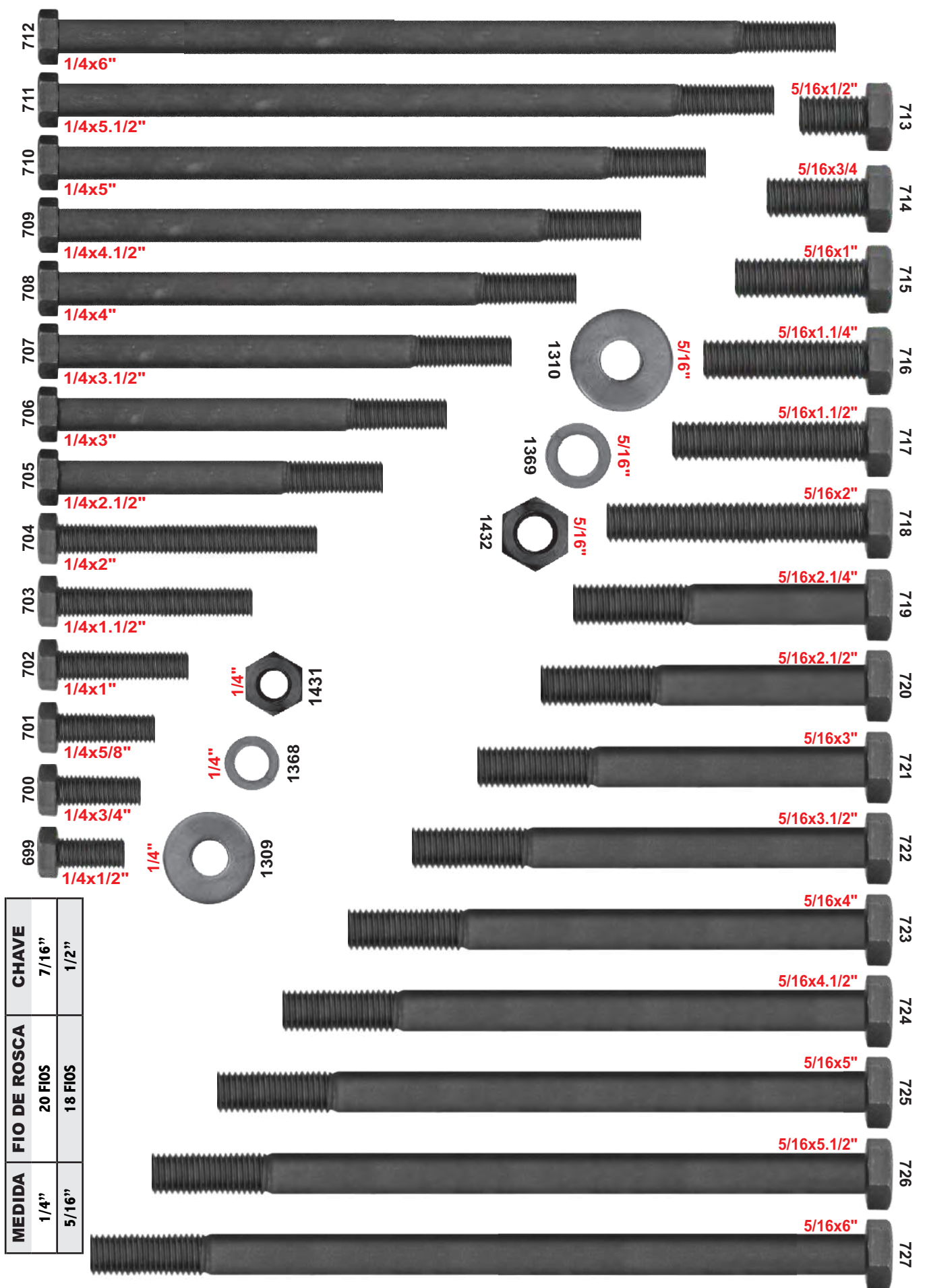

MEDIDA	FIO DE ROSCA	CHAVE
5/16"	18 FIOS	7/16"
1/4"	20 FIOS	7/16"

PARAFUSO SEXTAVADO AÇO GRAU 5 ROSCA GROSSA (UNC) 3/8"

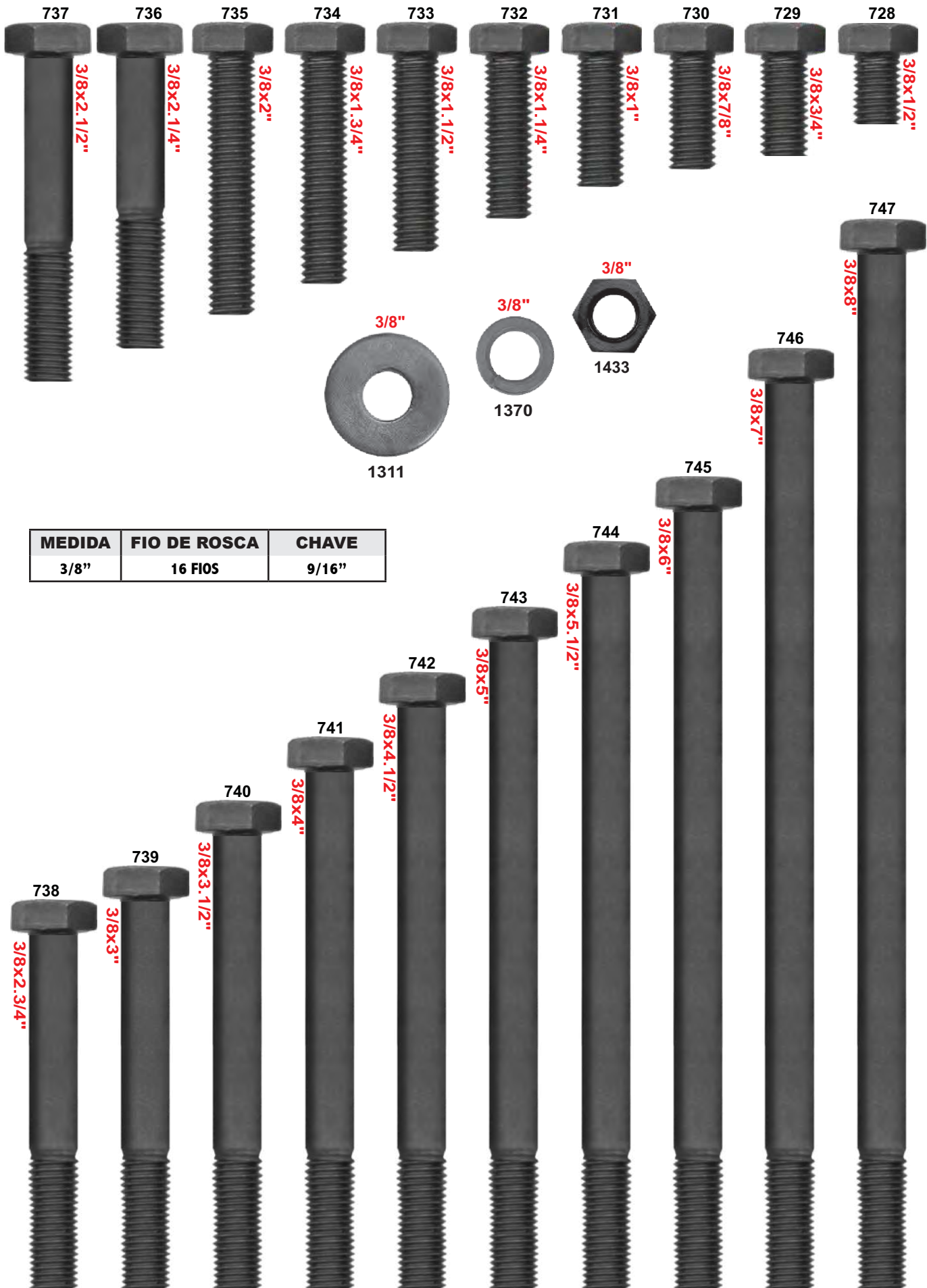

MEDIDA	FIO DE ROSCA	CHAVE
3/8"	16 FIOS	9/16"

1
2
3
4
5
6
7
8
9
10

PARAFUSO SEXTAVADO AÇO GRAU 5 ROSCA GROSSA (UNC) 7/16"

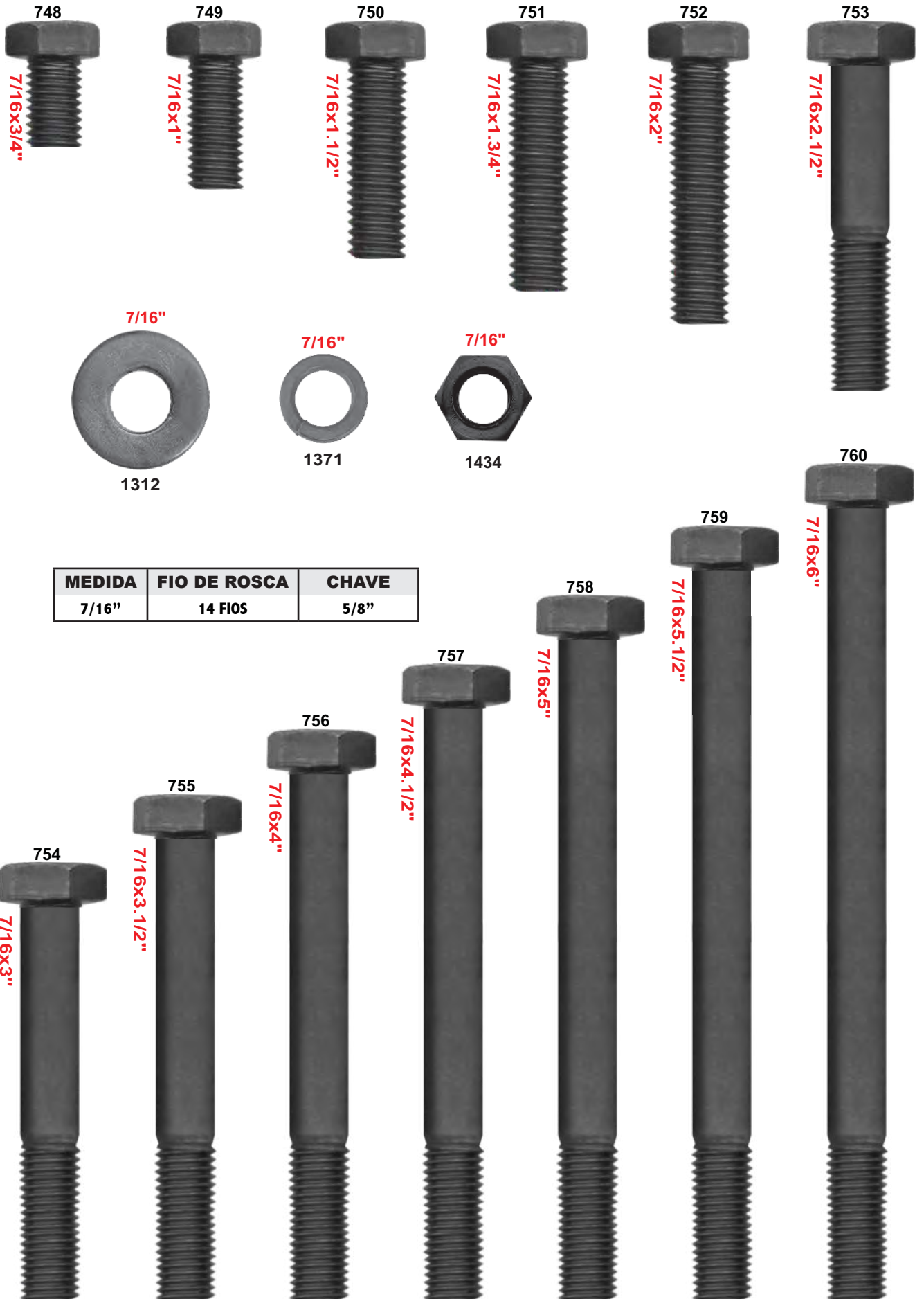

MEDIDA	FIO DE ROSCA	CHAVE
7/16"	14 FIOS	5/8"

1
2
3
4
5
6
7
8
9
10

PARAFUSO SEXTAVADO AÇO GRAU 5 ROSCA GROSSA (UNC) 1/2"

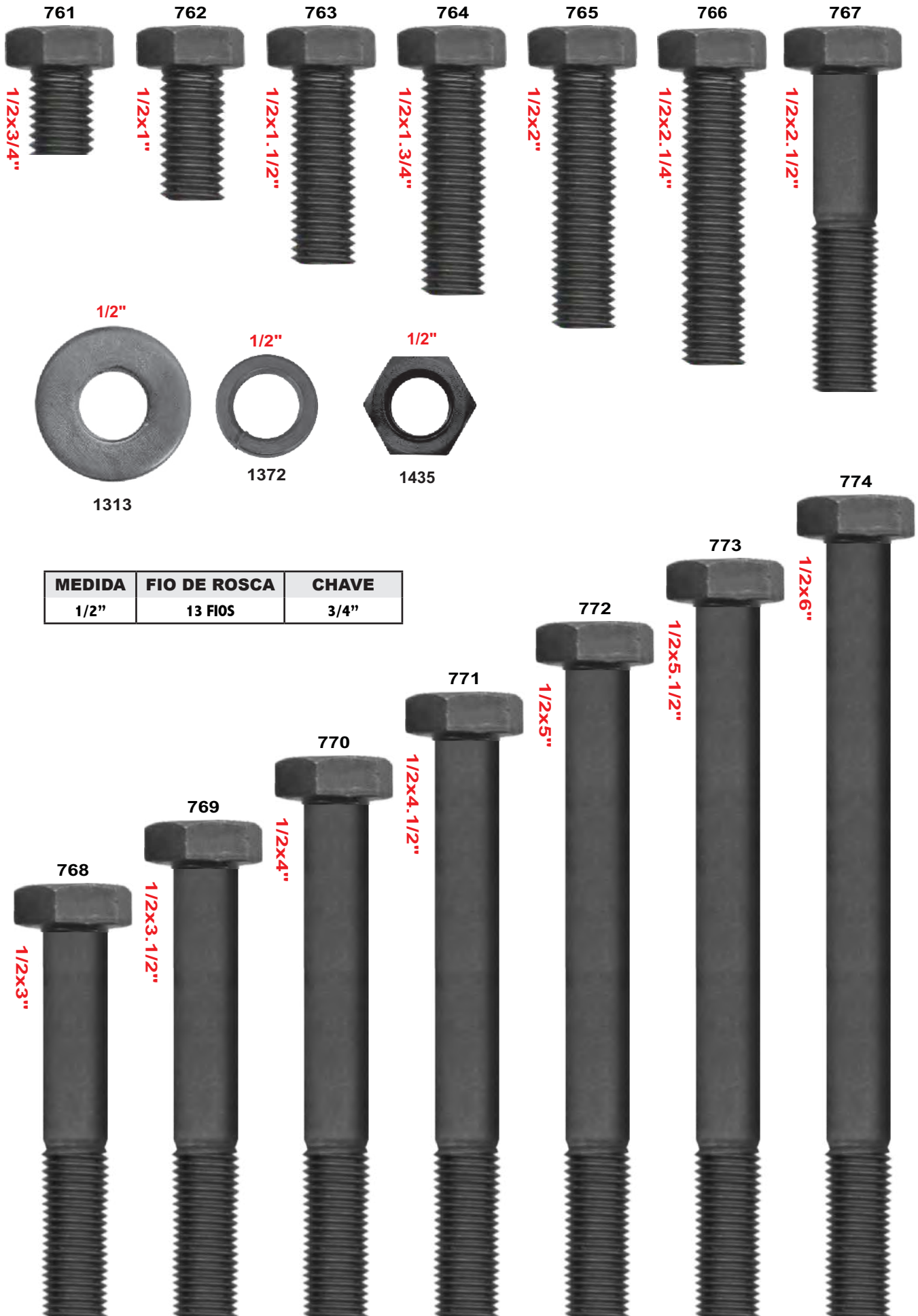

MEDIDA	FIO DE ROSCA	CHAVE
1/2"	13 FIOS	3/4"

PARAFUSO SEXTAVADO AÇO GRAU 5 ROSCA GROSSA (UNC) 1/2"

MEDIDA	FIO DE ROSCA	CHAVE
1/2"	13 FIOS	3/4"



PARAFUSO SEXTAVADO AÇO GRAU 5 ROSCA GROSSA (UNC) 9/16"

MEDIDA	FIO DE ROSCA	CHAVE
9/16"	12 FIOS	13/16"

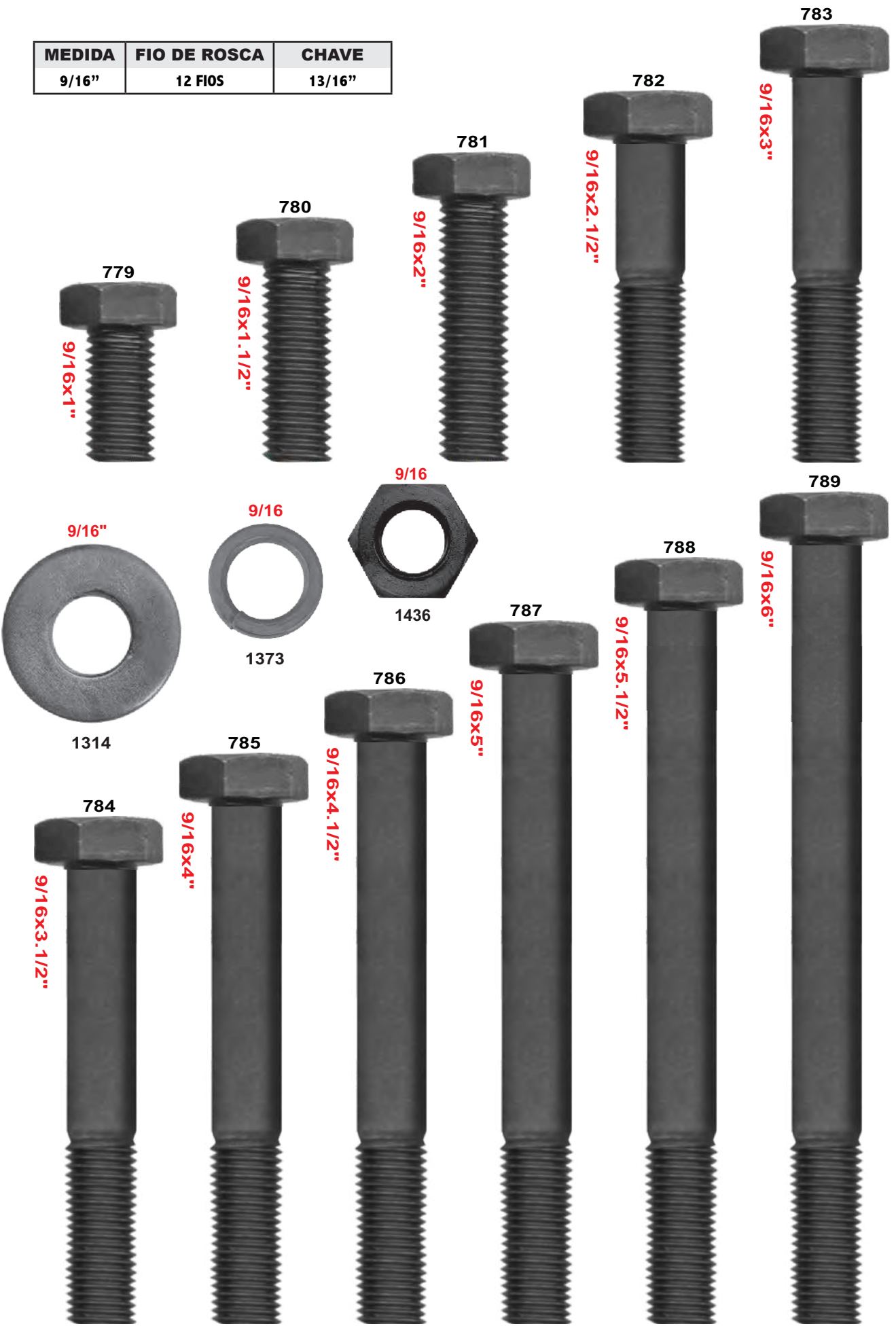

PARAFUSO SEXTAVADO AÇO GRAU 5 ROSCA GROSSA (UNC) 5/8"

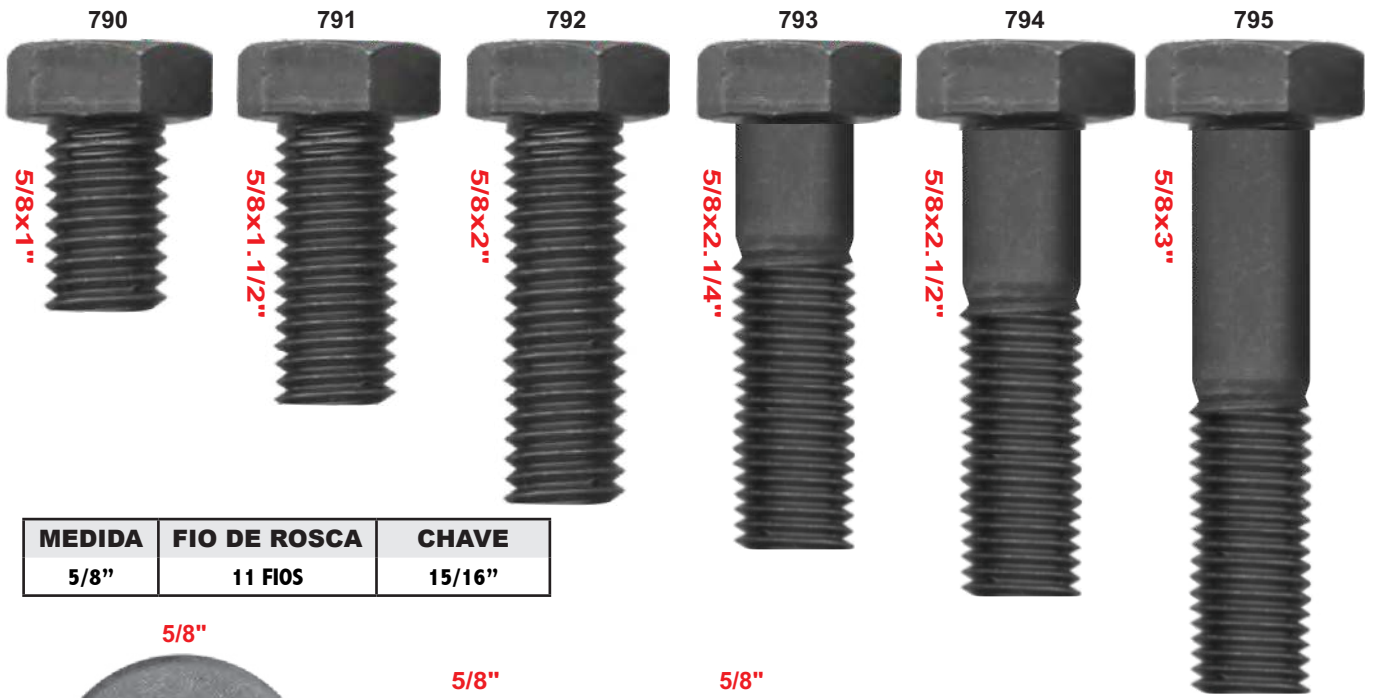

MEDIDA	FIO DE ROSCA	CHAVE
5/8"	11 FIOS	15/16"



PARAFUSO SEXTAVADO AÇO GRAU 5 ROSCA GROSSA (UNC) 5/8"

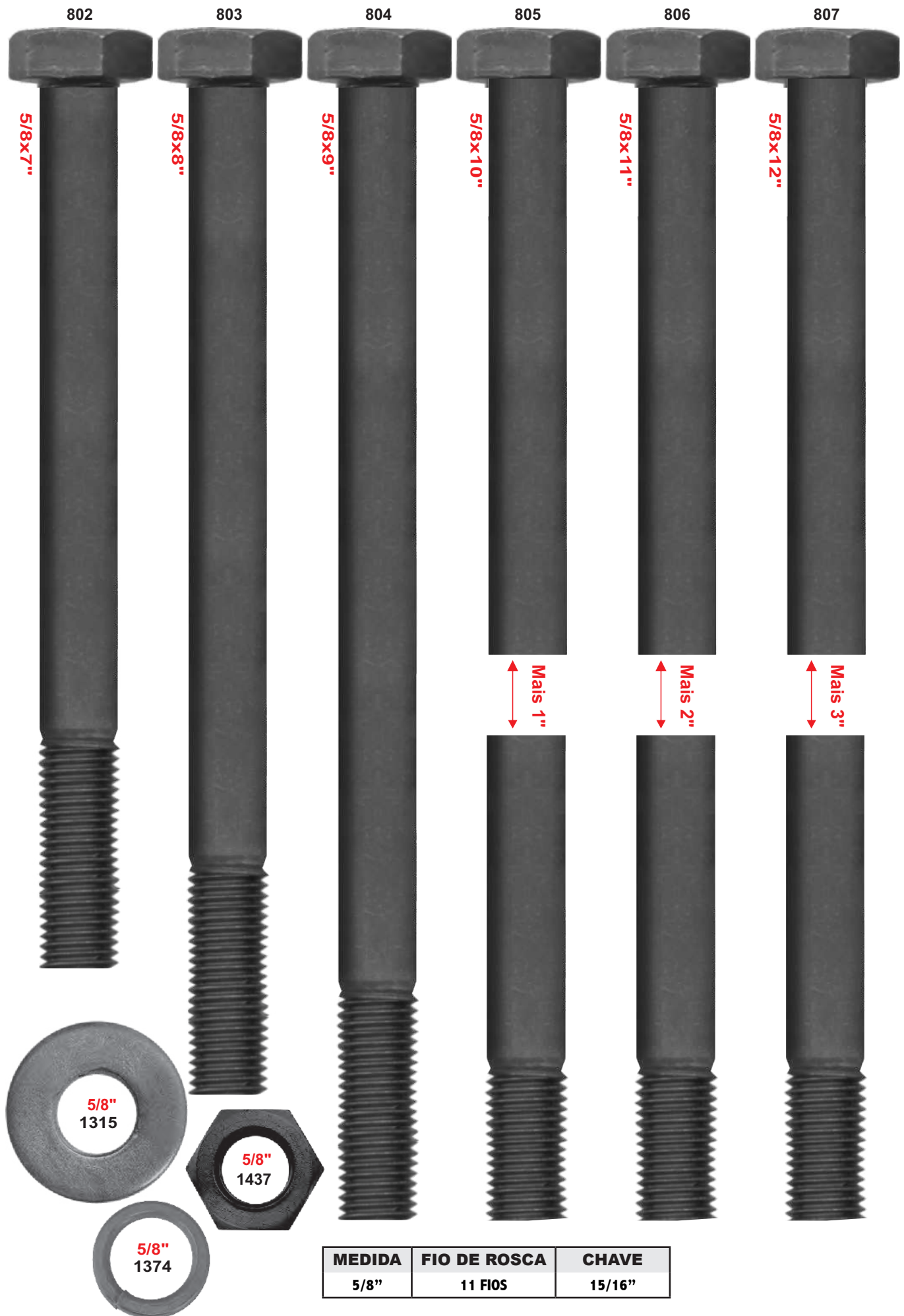

MEDIDA	FIO DE ROSCA	CHAVE
5/8"	11 FIOS	15/16"

PARAFUSO SEXTAVADO AÇO GRAU 5 ROSCA GROSSA (UNC) 3/4"



MEDIDA	FIO DE ROSCA	CHAVE
3/4"	10 FIOS	1.1/8"

1
2
3
4
5
6
7
8
9
10

PARAFUSO SEXTAVADO AÇO GRAU 5 ROSCA GROSSA (UNC) 3/4"



PARAFUSO SEXTAVADO AÇO GRAU 5 ROSCA GROSSA (UNC) 3/4"

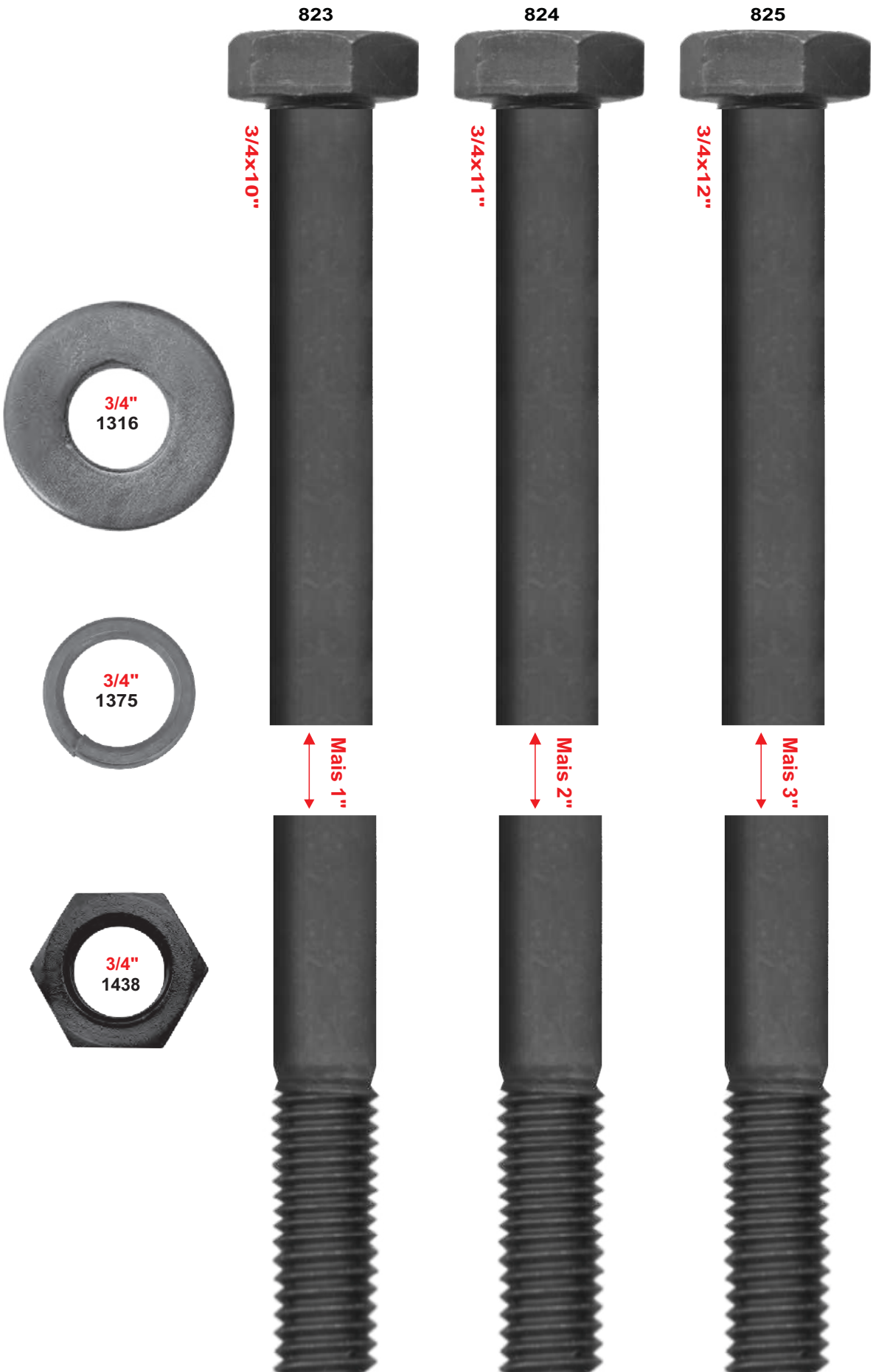

CHAVE	1.1/8"
FIO DE ROSCA	10 FIOS
MEDIDA	3/4"

PARAFUSO SEXTAVADO AÇO GRAU 5 ROSCA GROSSA (UNC) 7/8"



MEDIDA	FIO DE ROSCA	CHAVE
7/8"	9 FIOS	1.5/16"



PARAFUSO SEXTAVADO AÇO GRAU 5 ROSCA GROSSA (UNC) 7/8"



PARAFUSO SEXTAVADO AÇO GRAU 5 ROSCA GROSSA (UNC) 1"

839



840



841



842



846



845



844



843



MEDIDA	FIO DE ROSCA	CHAVE
1"	8 FIOS	1.1/2"

PARAFUSO SEXTAVADO AÇO GRAU 5 ROSCA GROSSA (UNC) 1"

MEDIDA	FIO DE ROSCA	CHAVE
1"	8 FIOS	1.1/2"



PARAFUSO SEXTAVADO AÇO GRAU 5 ROSCA GROSSA (UNC) 1"

0
1
2
3
4
5
6
7
8
9
10
11
12
13
14
15
16
17
18
19
20
21
22
23
24
25
26
27
28
29
30
31
32
33
34
35
36
37
38
39
40
41
42
43
44
45
46
47
48
49
50
51
52
53
54
55
56
57
58
59
60
61
62
63
64
65
66
67
68
69
70
71
72
73
74
75
76
77
78
79
80
81
82
83
84
85
86
87
88
89
90
91
92
93
94
95
96
97
98
99



MEDIDA	FIO DE ROSCA	CHAVE
1"	8 FIOS	1.1/2"

PARAFUSO SEXTAVADO AÇO GRAU 5 ROSCA FINA (UNF) 1/4"

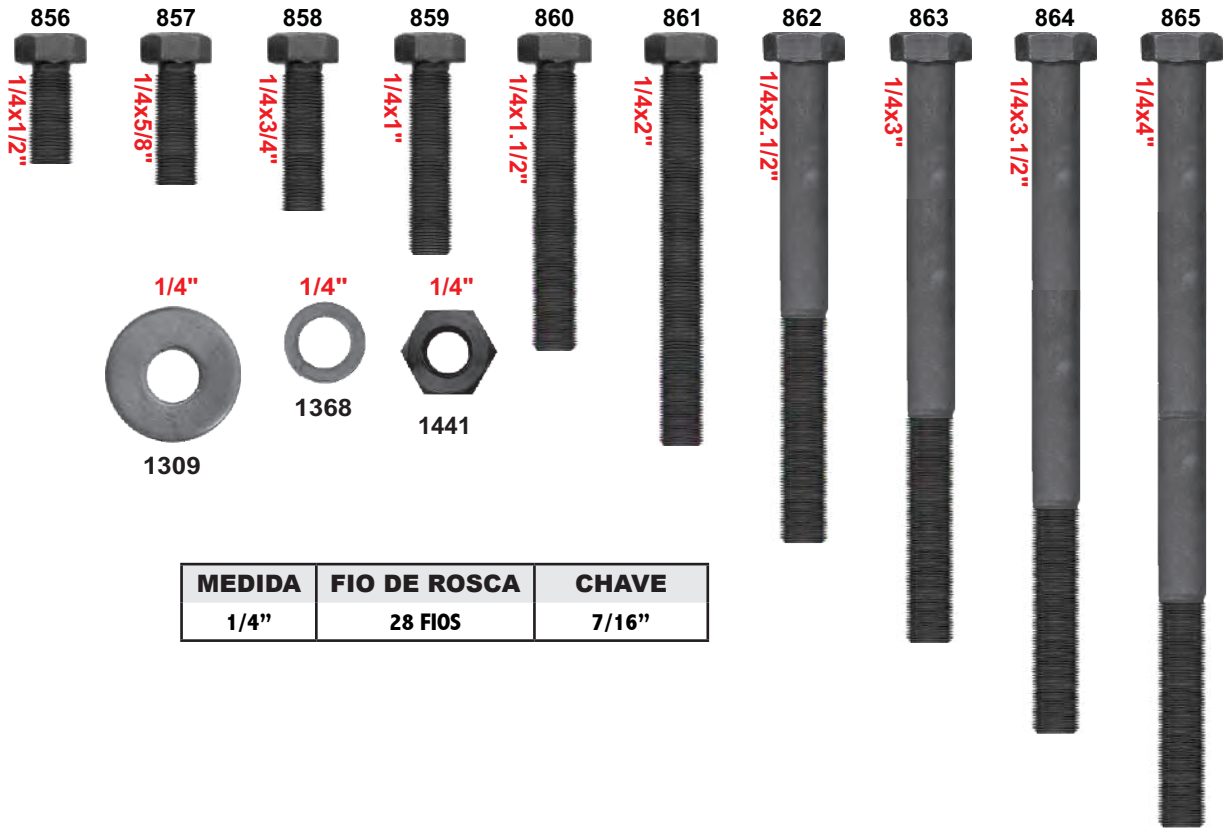

MEDIDA	FIO DE ROSCA	CHAVE
1/4"	28 FIOS	7/16"

PARAFUSO SEXTAVADO AÇO GRAU 5 ROSCA FINA (UNF) 5/16"

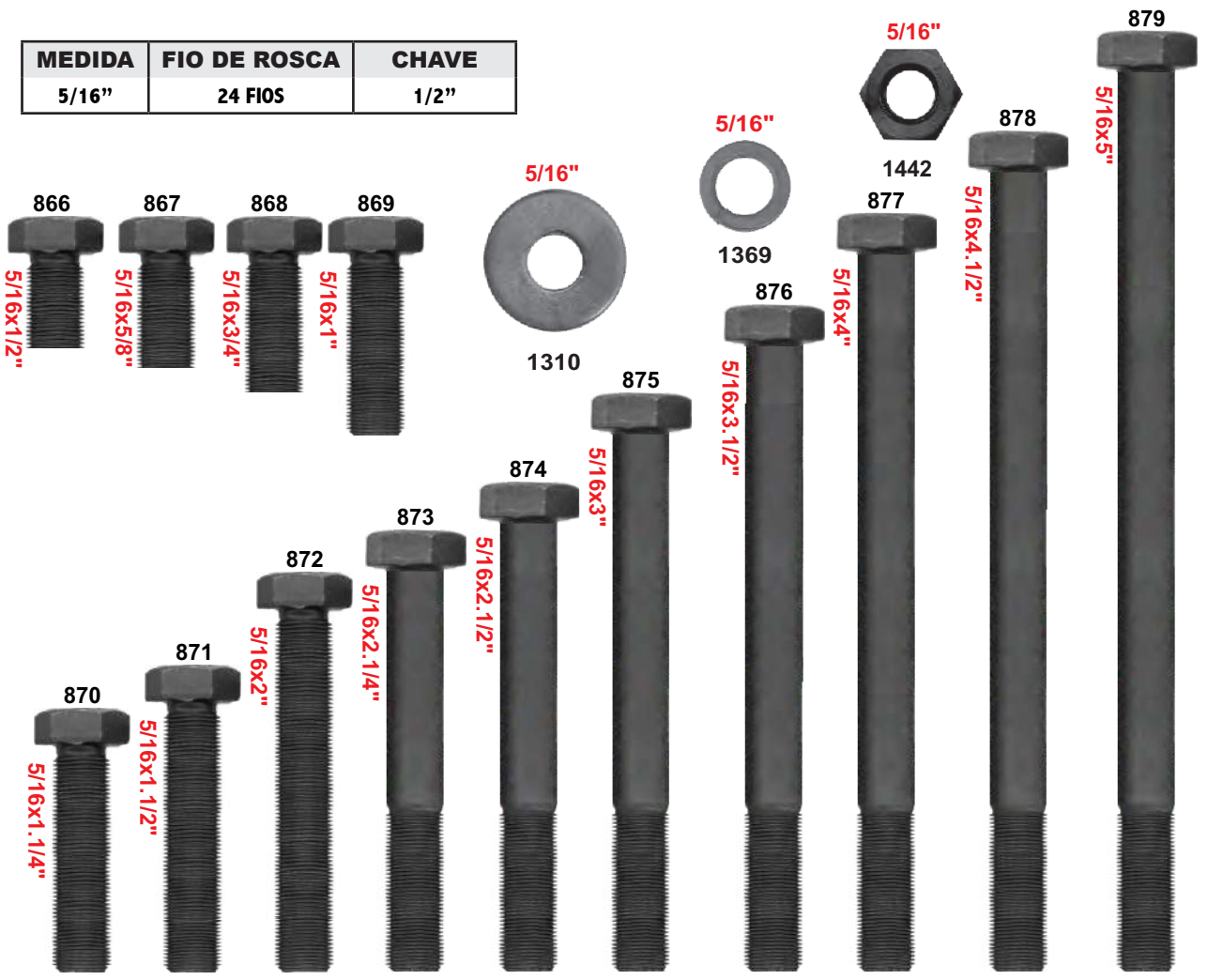

MEDIDA	FIO DE ROSCA	CHAVE
5/16"	24 FIOS	1/2"

PARAFUSO SEXTAVADO AÇO GRAU 5 ROSCA FINA (UNF) 3/8"

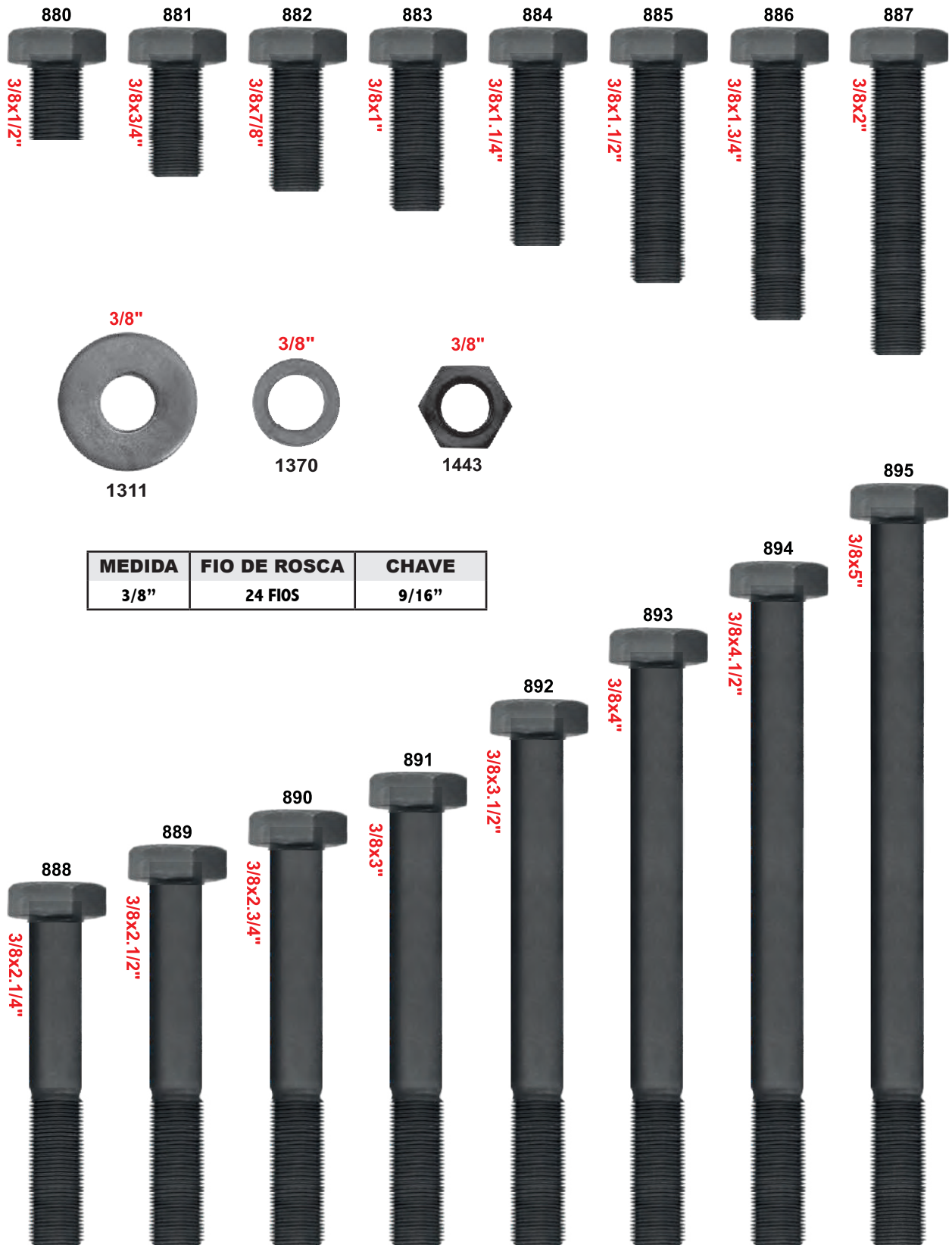

MEDIDA	FIO DE ROSCA	CHAVE
3/8"	24 FIOS	9/16"

PARAFUSO SEXTAVADO AÇO GRAU 5 ROSCA FINA (UNF) 7/16"

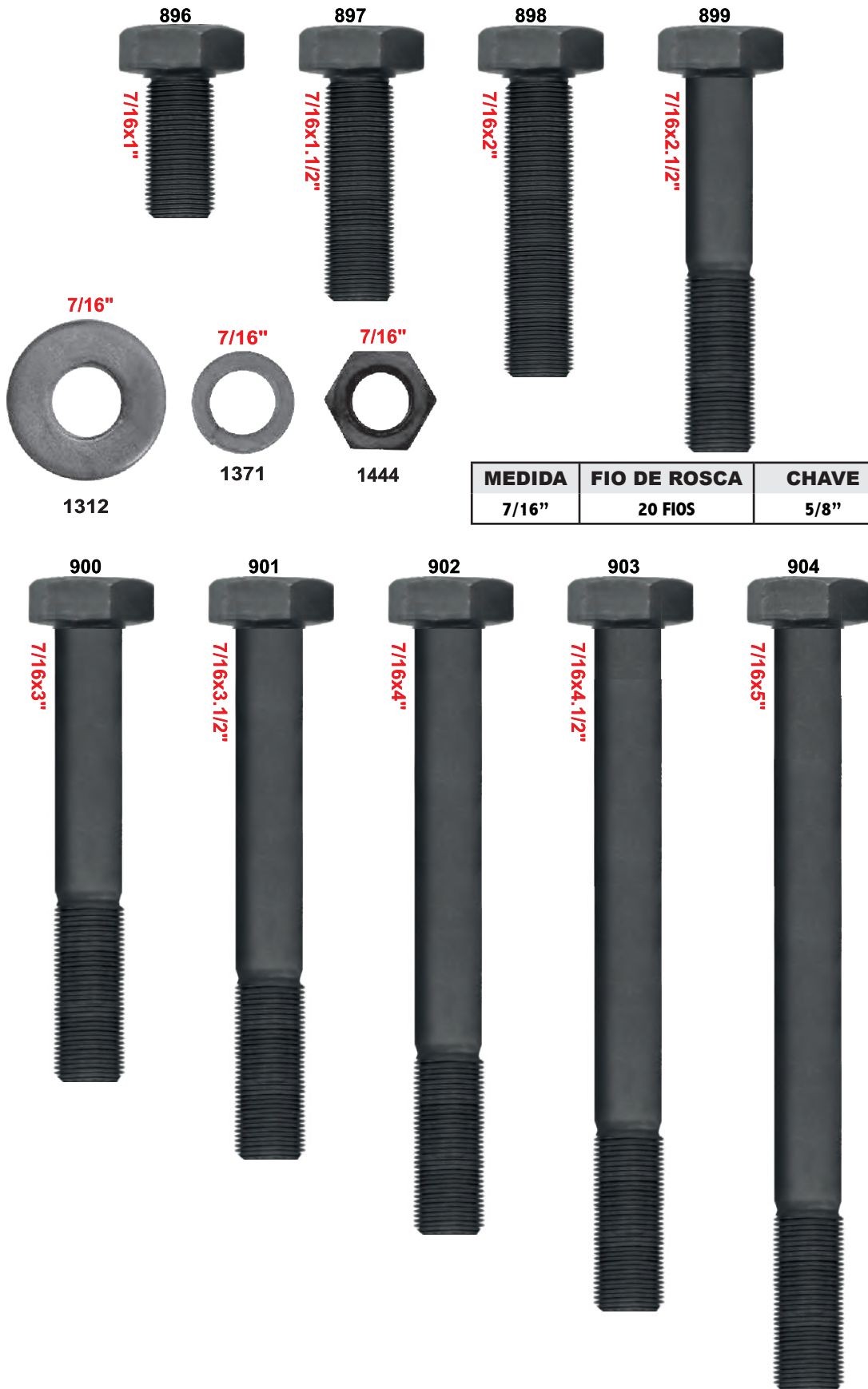

PARAFUSO SEXTAVADO AÇO GRAU 5 ROSCA FINA (UNF) 1/2"

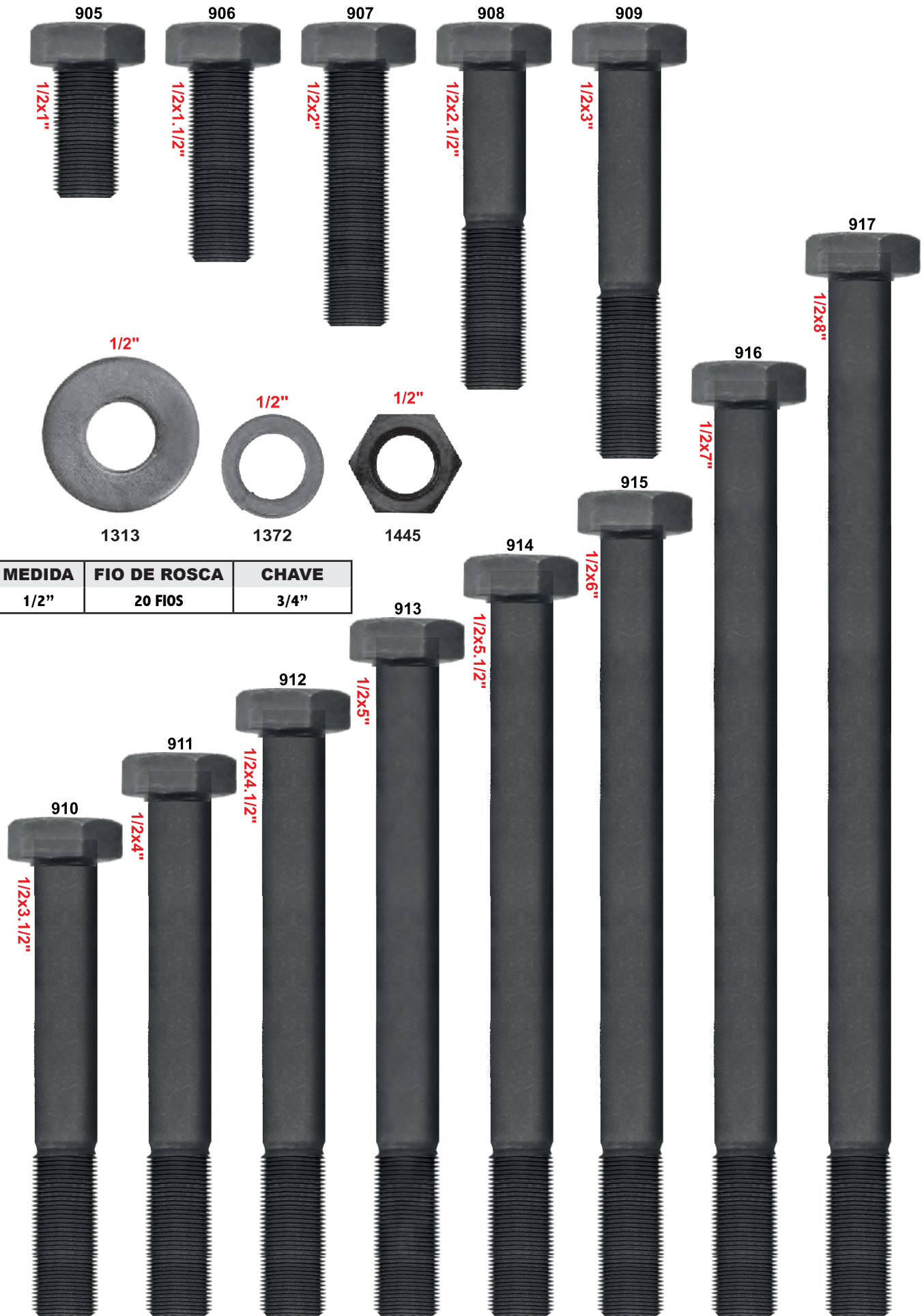

MEDIDA	FIO DE ROSCA	CHAVE
1/2"	20 FIOS	3/4"

PARAFUSO SEXTAVADO AÇO GRAU 5 ROSCA FINA (UNF) 9/16"



MEDIDA	FIO DE ROSCA	CHAVE
9/16"	18 FIOS	13/16"



PARAFUSO SEXTAVADO AÇO GRAU 5 ROSCA FINA (UNF) 5/8"



MEDIDA	FIO DE ROSCA	CHAVE
5/8"	18 FIOS	15/16"

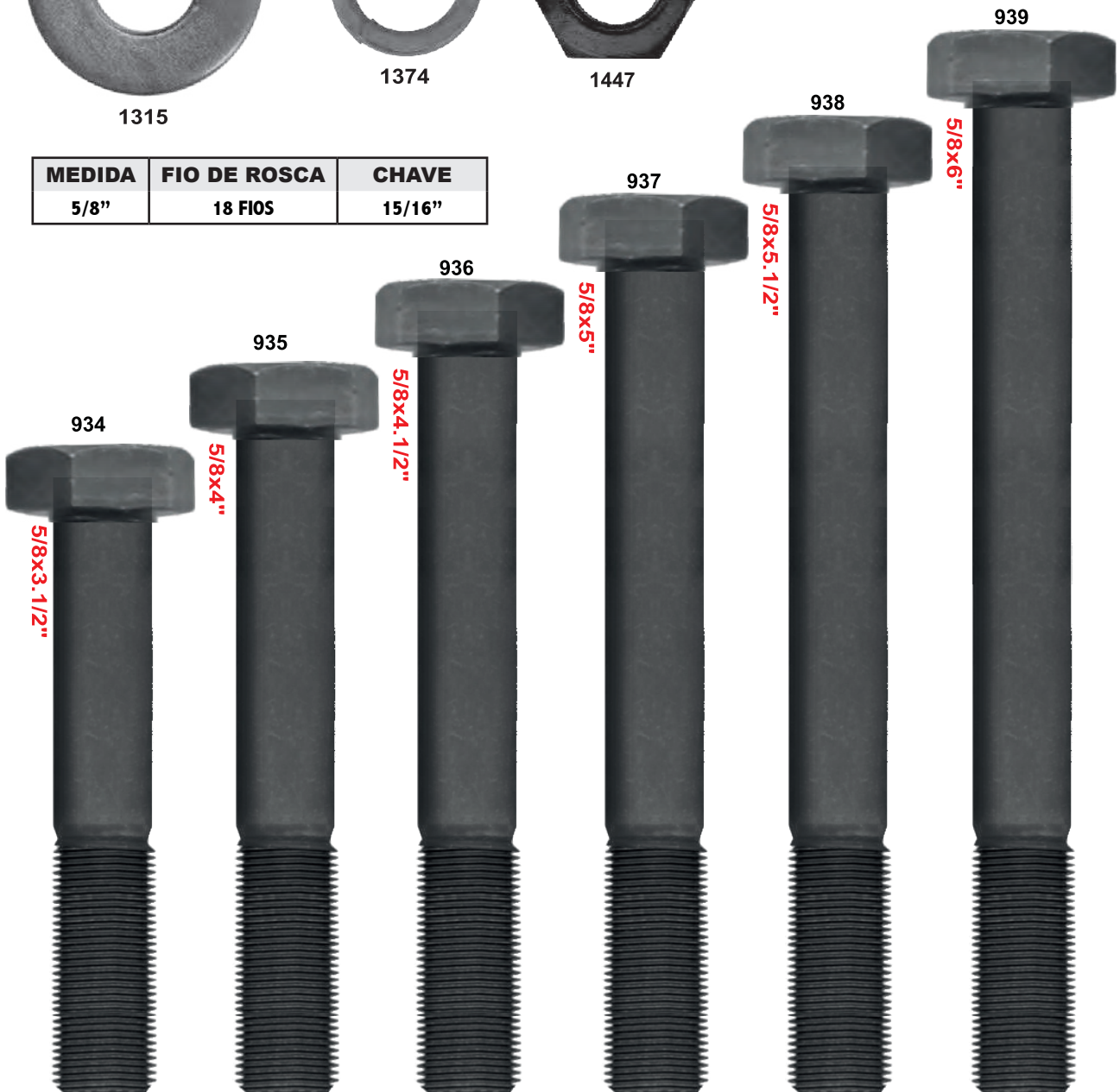

PARAFUSO SEXTAVADO AÇO GRAU 5 ROSCA FINA (UNF) 3/4"

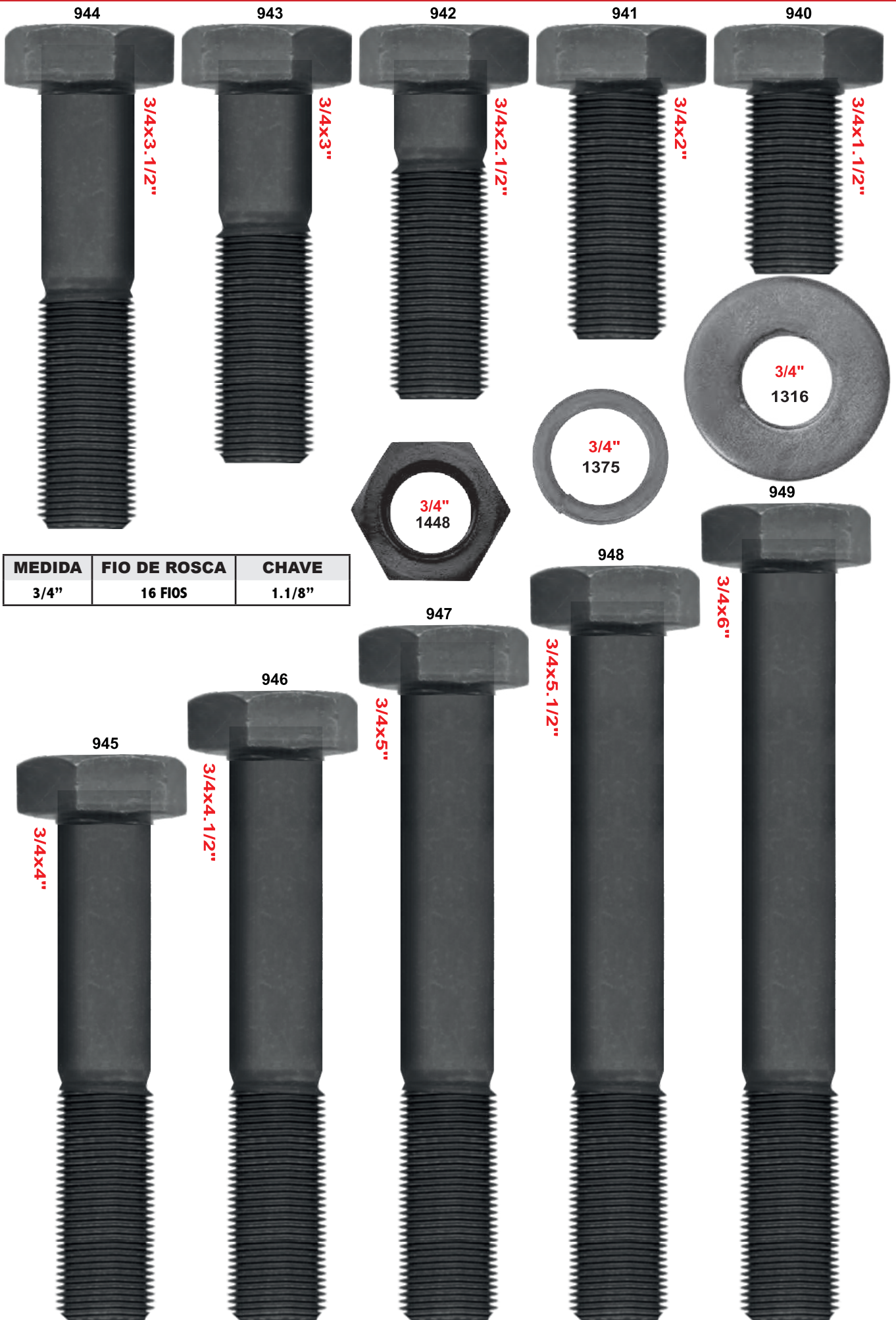

MEDIDA	FIO DE ROSCA	CHAVE
3/4"	16 FIOS	1.1/8"

1
2
3
4
5
6
7
8
9
10

PARAFUSO SEXTAVADO AÇO 5.8 ROSCA GROSSA ZINCADO (MA) M-5

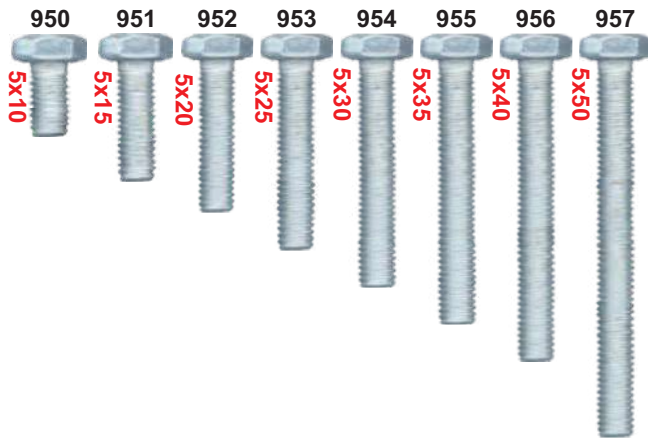

MEDIDA	FIO DE ROSCA	CHAVE
5MM	0,80	8MM

PARAFUSO SEXTAVADO AÇO 5.8 ROSCA GROSSA ZINCADO (MA) M-6

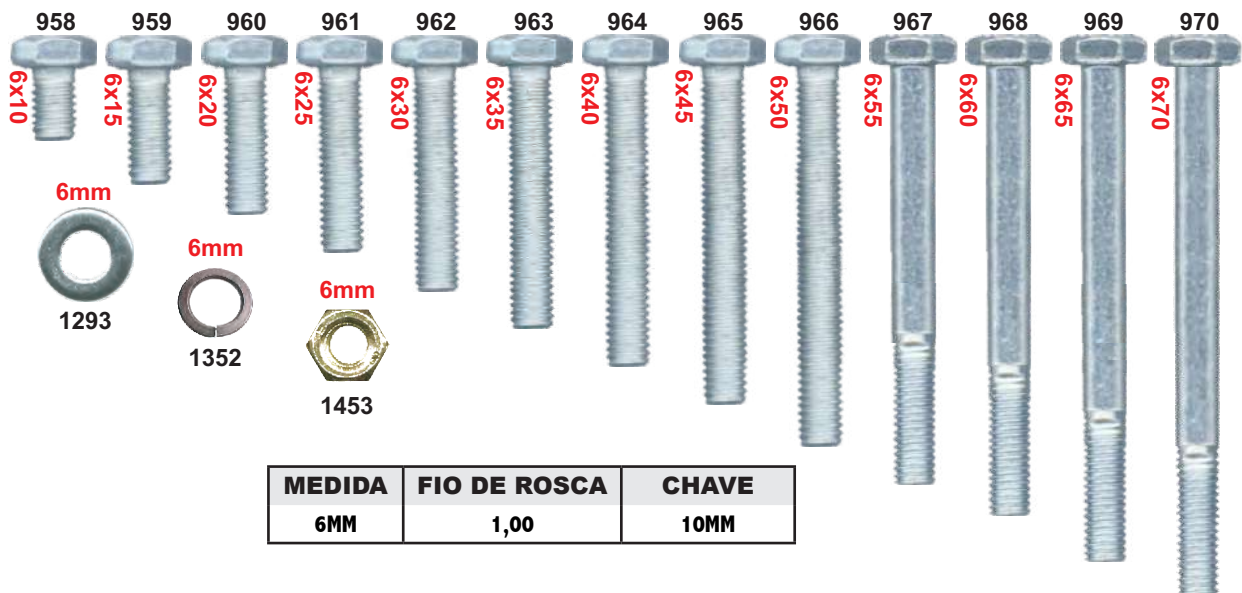

MEDIDA	FIO DE ROSCA	CHAVE
6MM	1,00	10MM

PARAFUSO SEXTAVADO AÇO 5.8 ROSCA GROSSA ZINCADO (MA) M-7

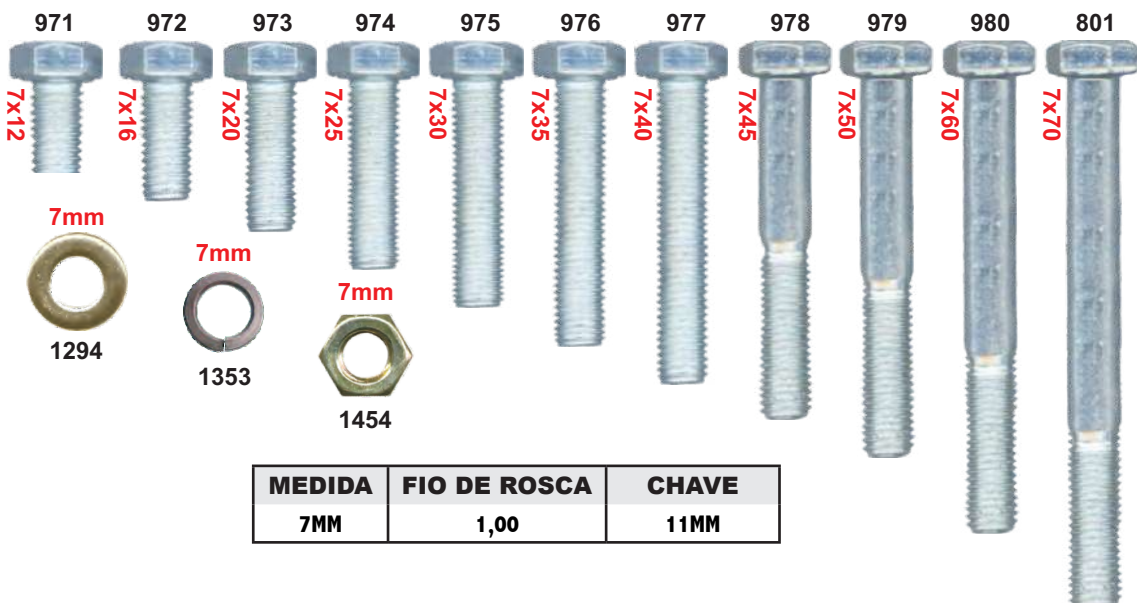

MEDIDA	FIO DE ROSCA	CHAVE
7MM	1,00	11MM

PARAFUSO SEXTAVADO AÇO 5.8 ROSCA GROSSA ZINCADO (MA) M-8

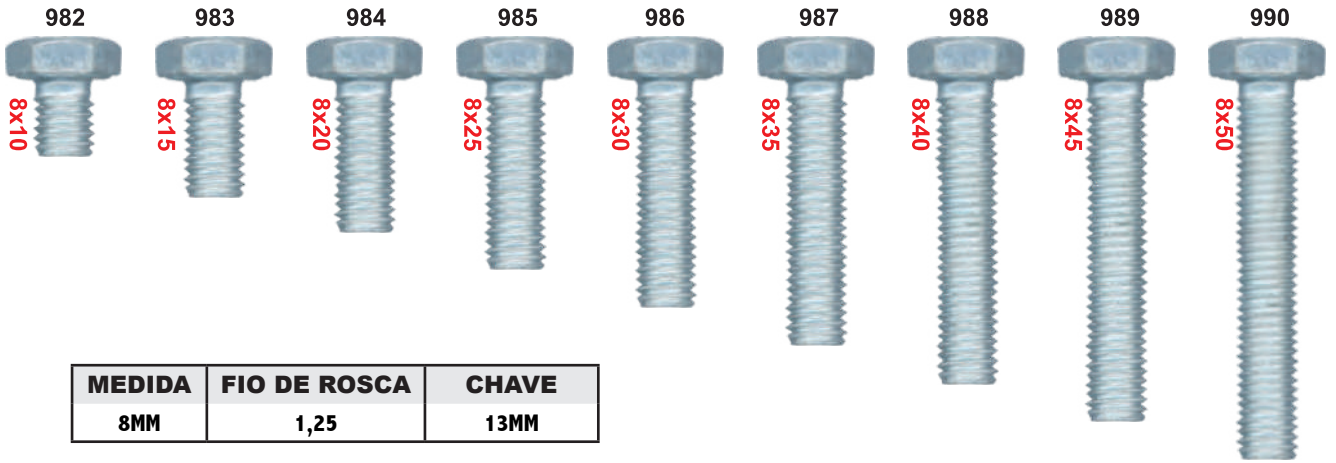

MEDIDA	FIO DE ROSCA	CHAVE
8MM	1,25	13MM

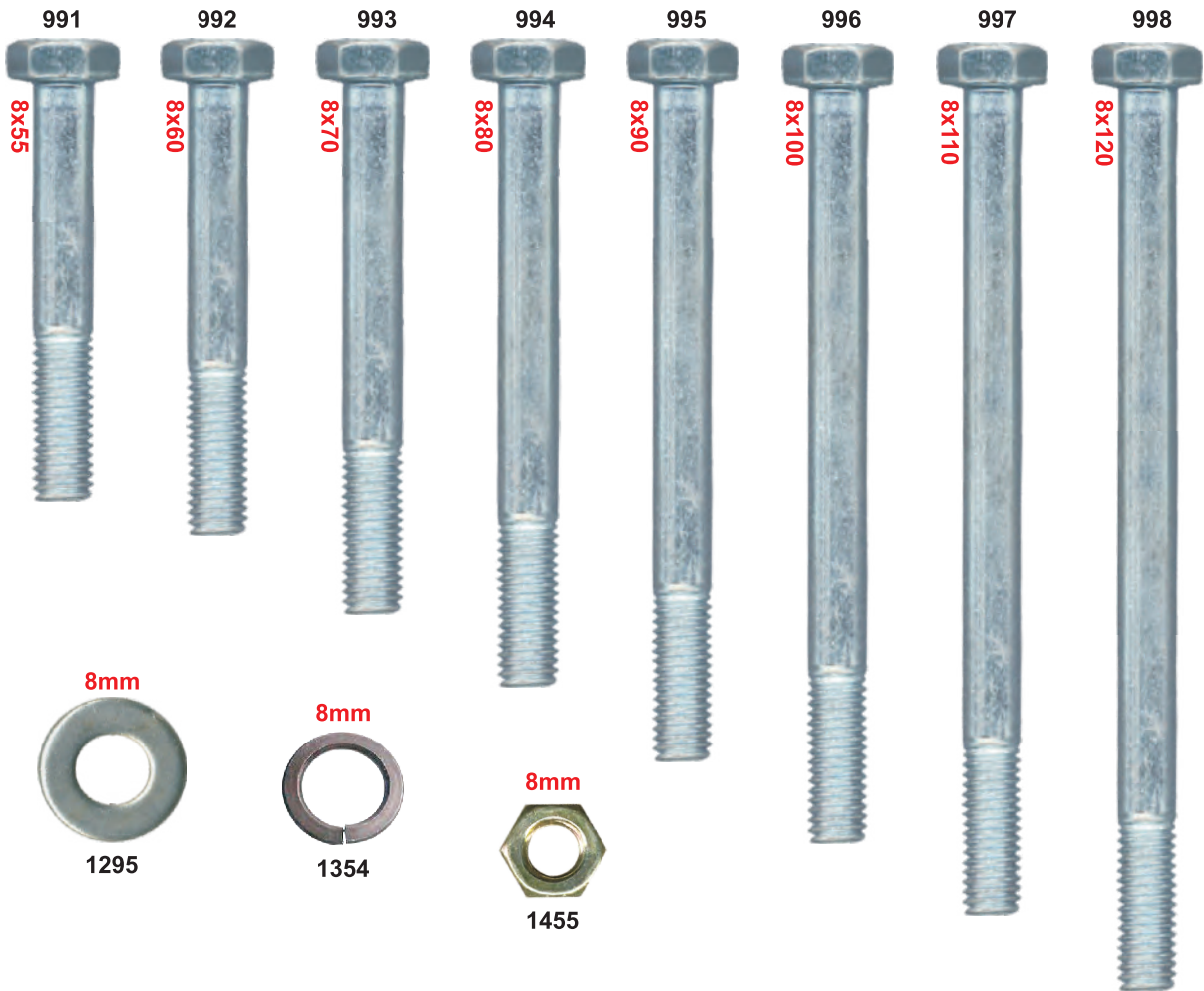

PARAFUSO SEXTAVADO AÇO 5.8 ROSCA GROSSA ZINCADO (MA) M-10

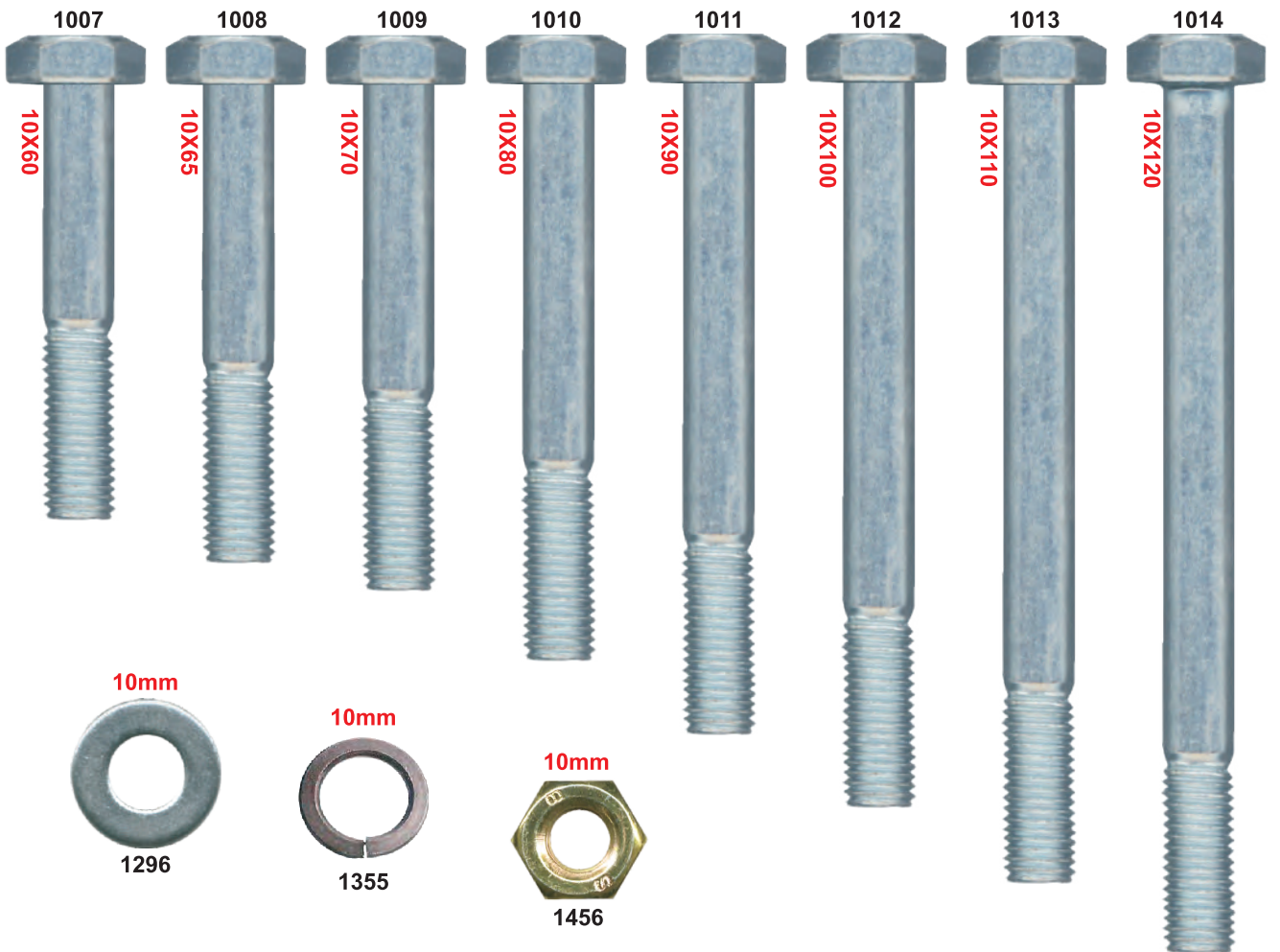
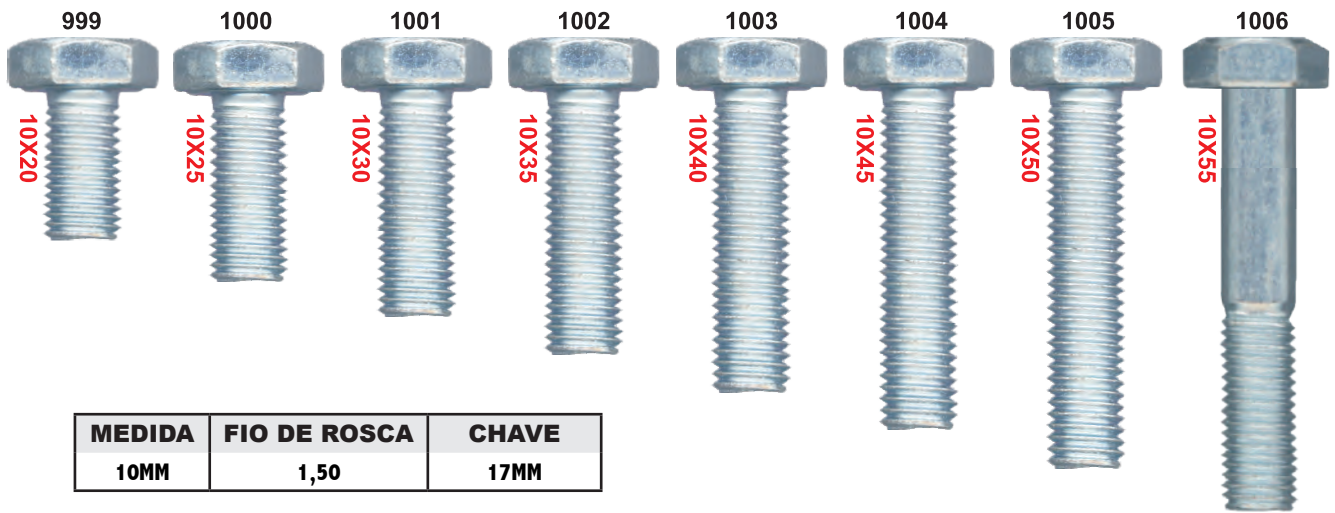

PARAFUSO SEXTAVADO AÇO GRAU 2 ROSCA GROSSA ZINCADO (UNC) 1/4"

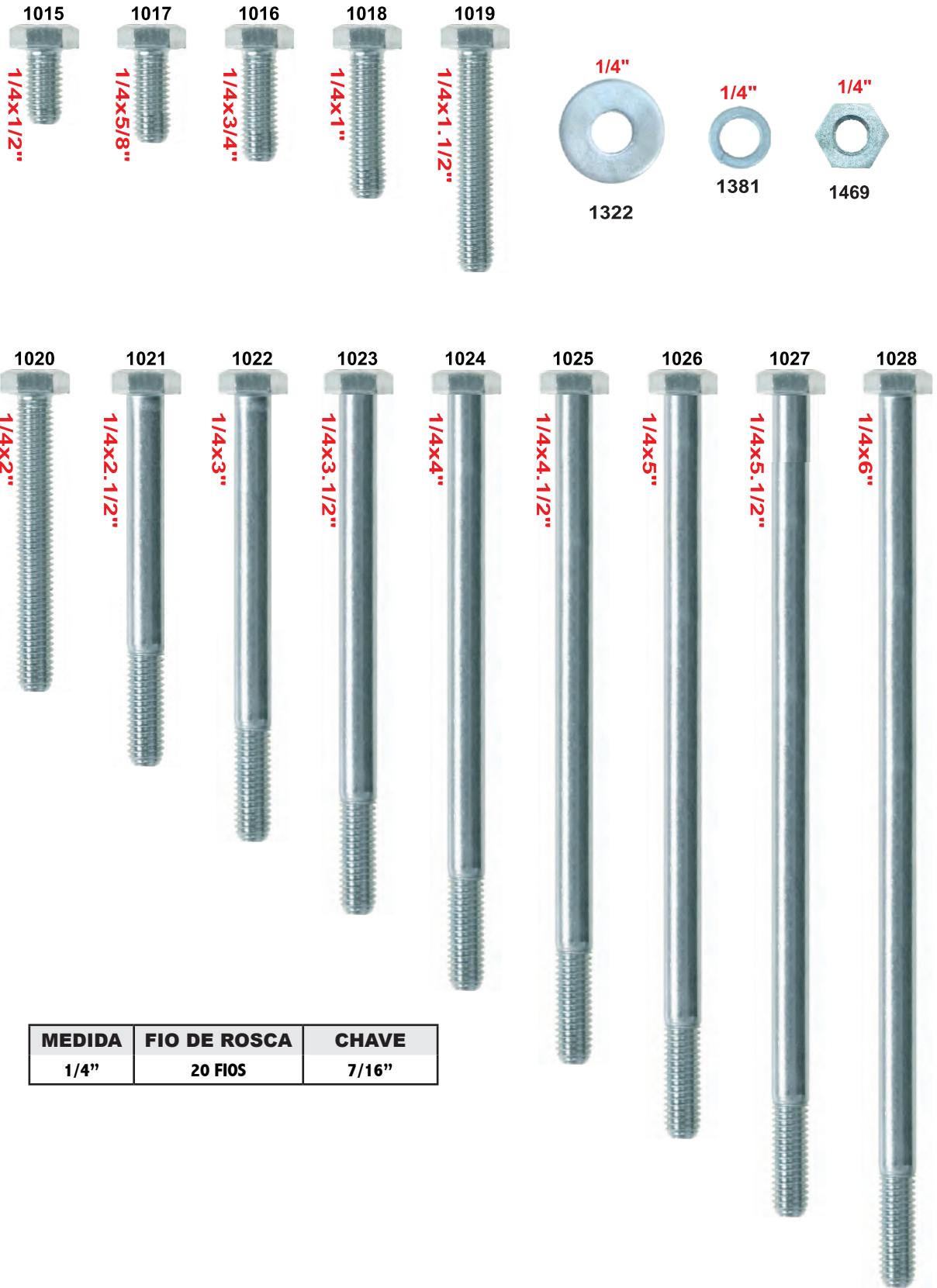

MEDIDA	FIO DE ROSCA	CHAVE
1/4"	20 FIOS	7/16"

PARAFUSO SEXTAVADO AÇO GRAU 2 ROSCA GROSSA ZINCADO (UNC) 5/16"

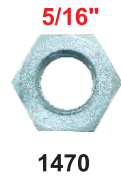

MEDIDA	FIO DE ROSCA	CHAVE
5/16"	18 FIOS	1/2"

PARAFUSO SEXTAVADO AÇO GRAU 2 ROSCA GROSSA ZINCADO (UNC) 3/8"

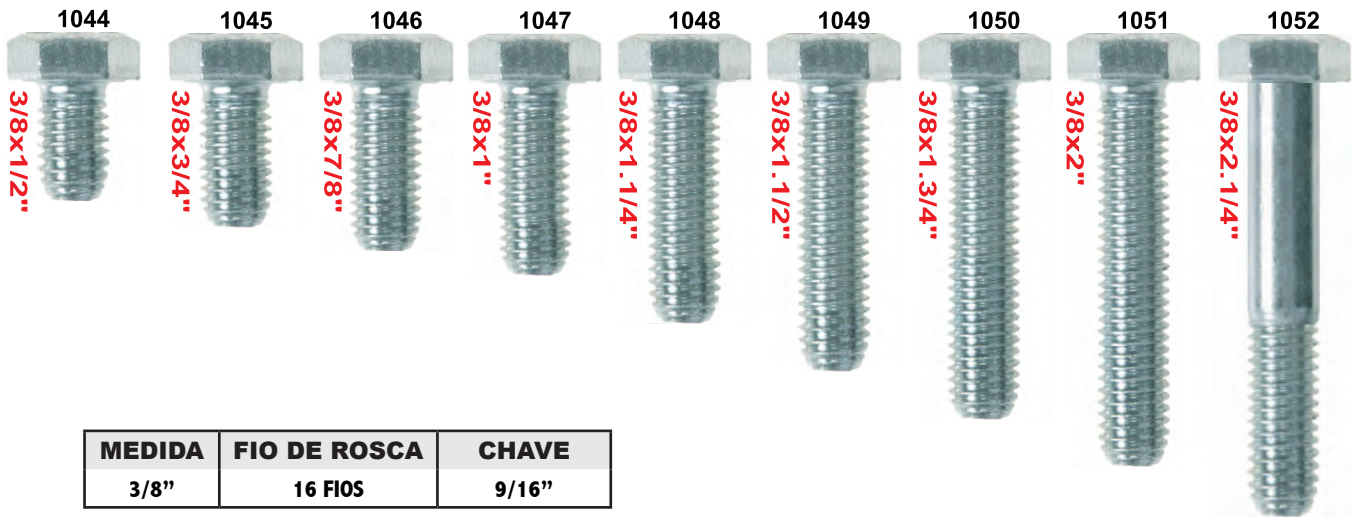

MEDIDA	FIO DE ROSCA	CHAVE
3/8"	16 FIOS	9/16"

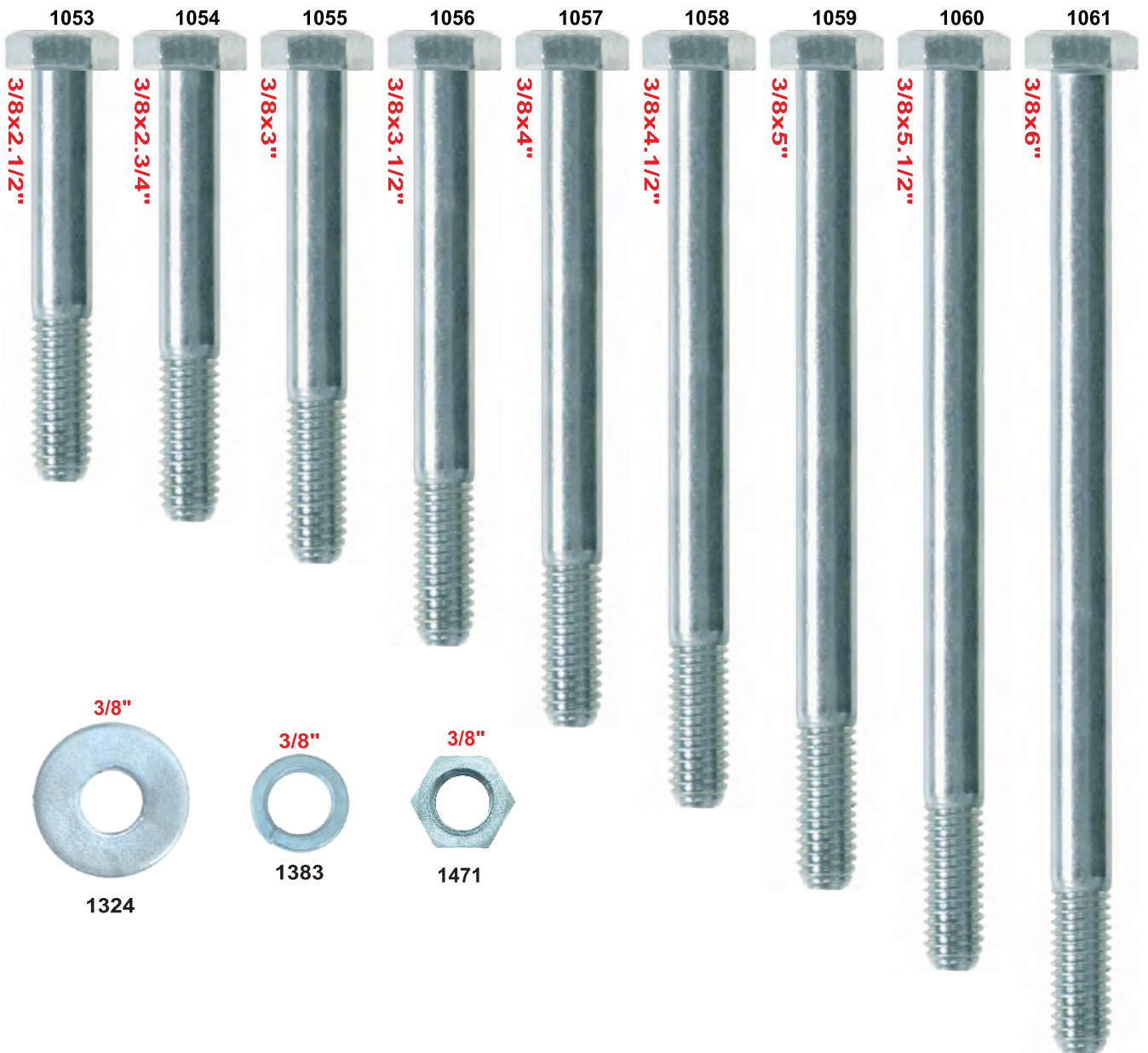

1324



1383



1471

1
2
3
4
5
6
7
8
9
10

PARAFUSO SEXTAVADO AÇO GRAU 2 ROSCA GROSSA ZINCADO (UNC) 7/16"

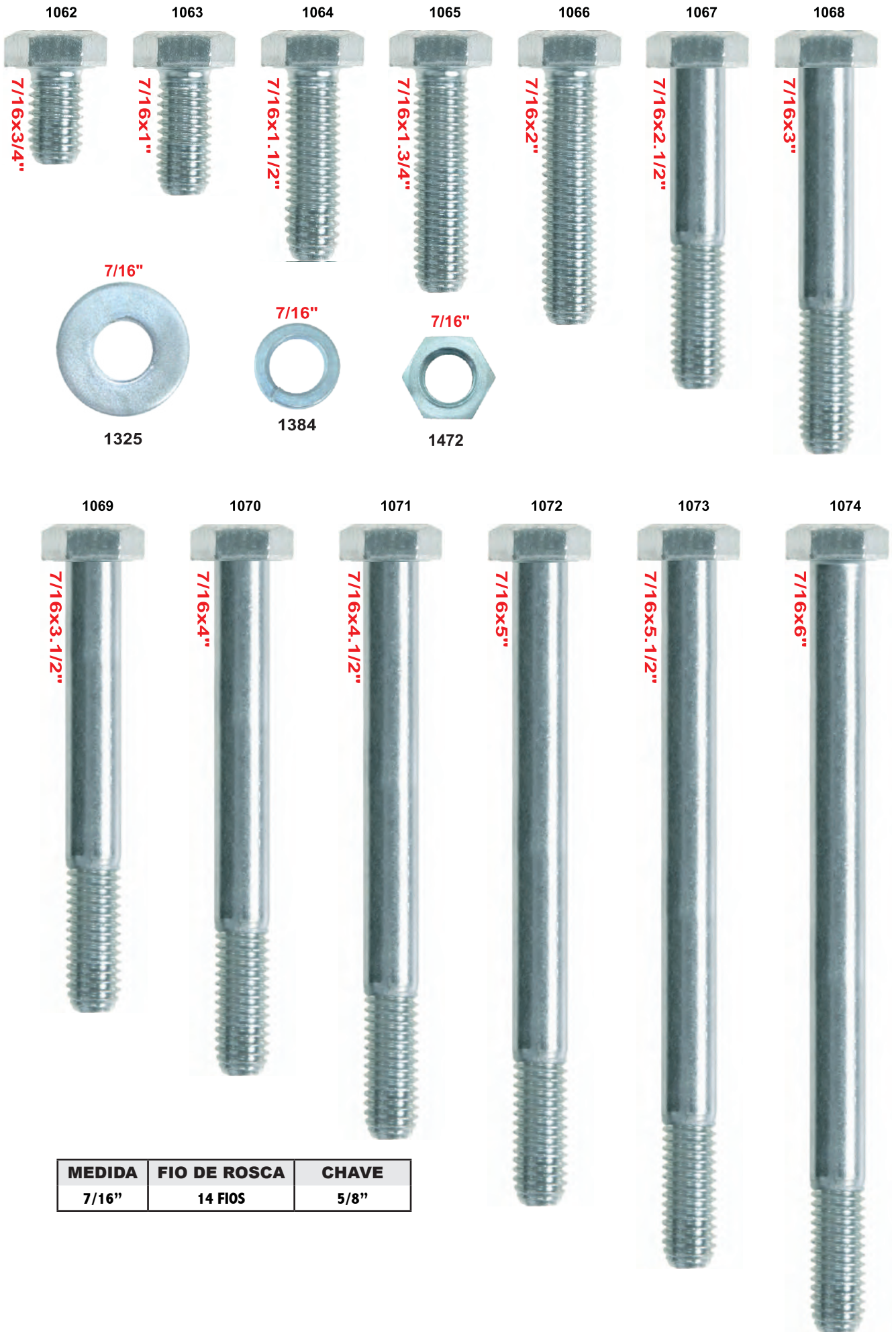

MEDIDA	FIO DE ROSCA	CHAVE
7/16"	14 FIOS	5/8"

PARAFUSO SEXTAVADO AÇO GRAU 2 ROSCA GROSSA ZINCADO (UNC) 1/2"

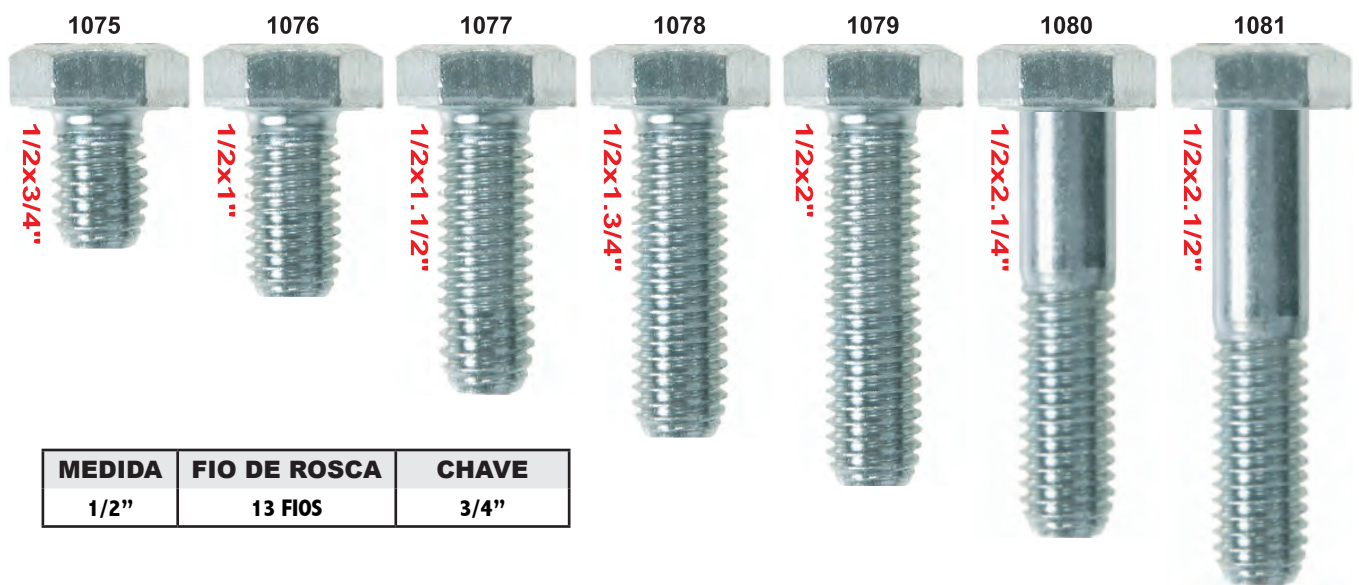

MEDIDA	FIO DE ROSCA	CHAVE
1/2"	13 FIOS	3/4"

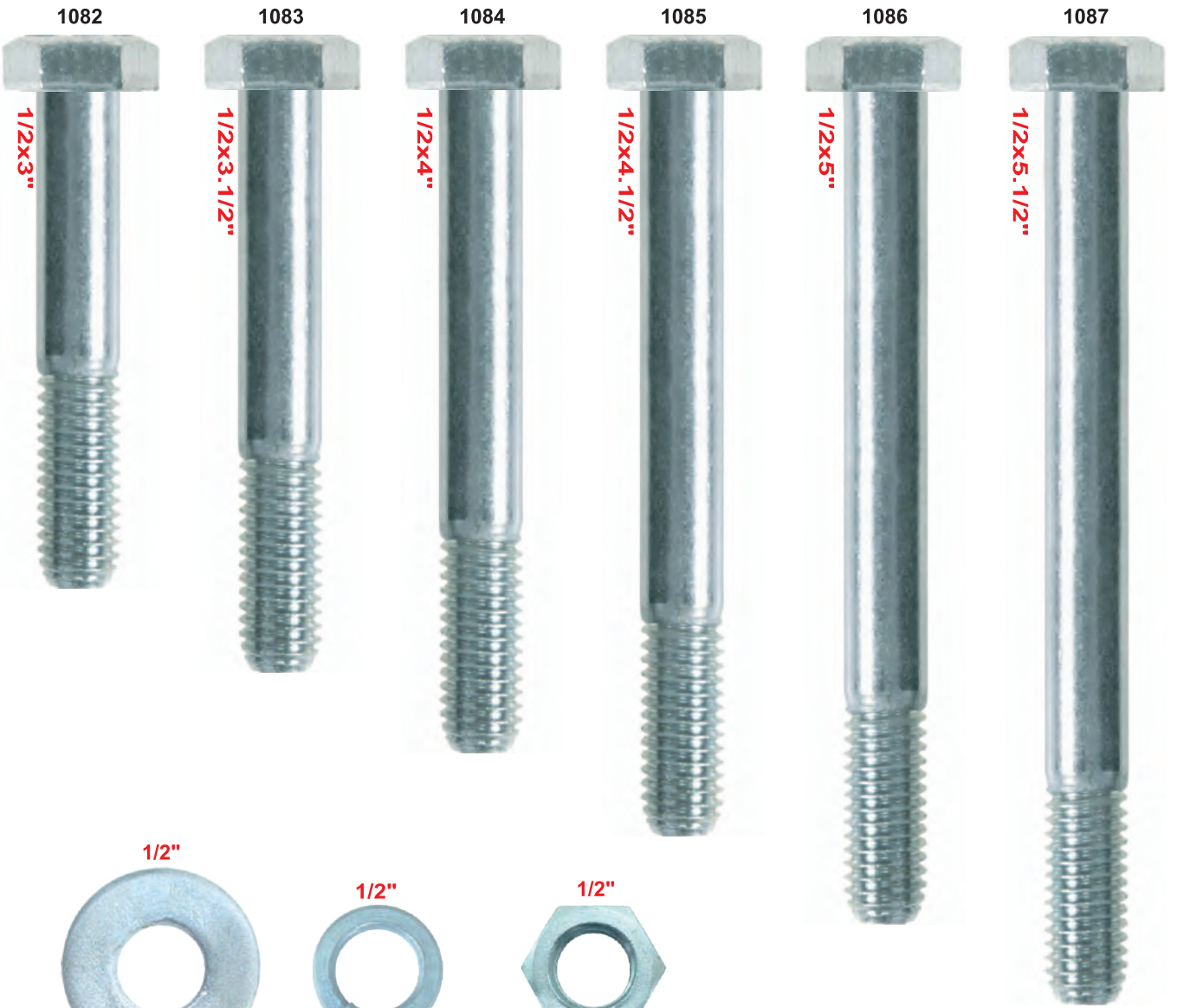

PARAFUSO SEXTAVADO AÇO GRAU 2 ROSCA GROSSA ZINCADO (UNC) 1/2"

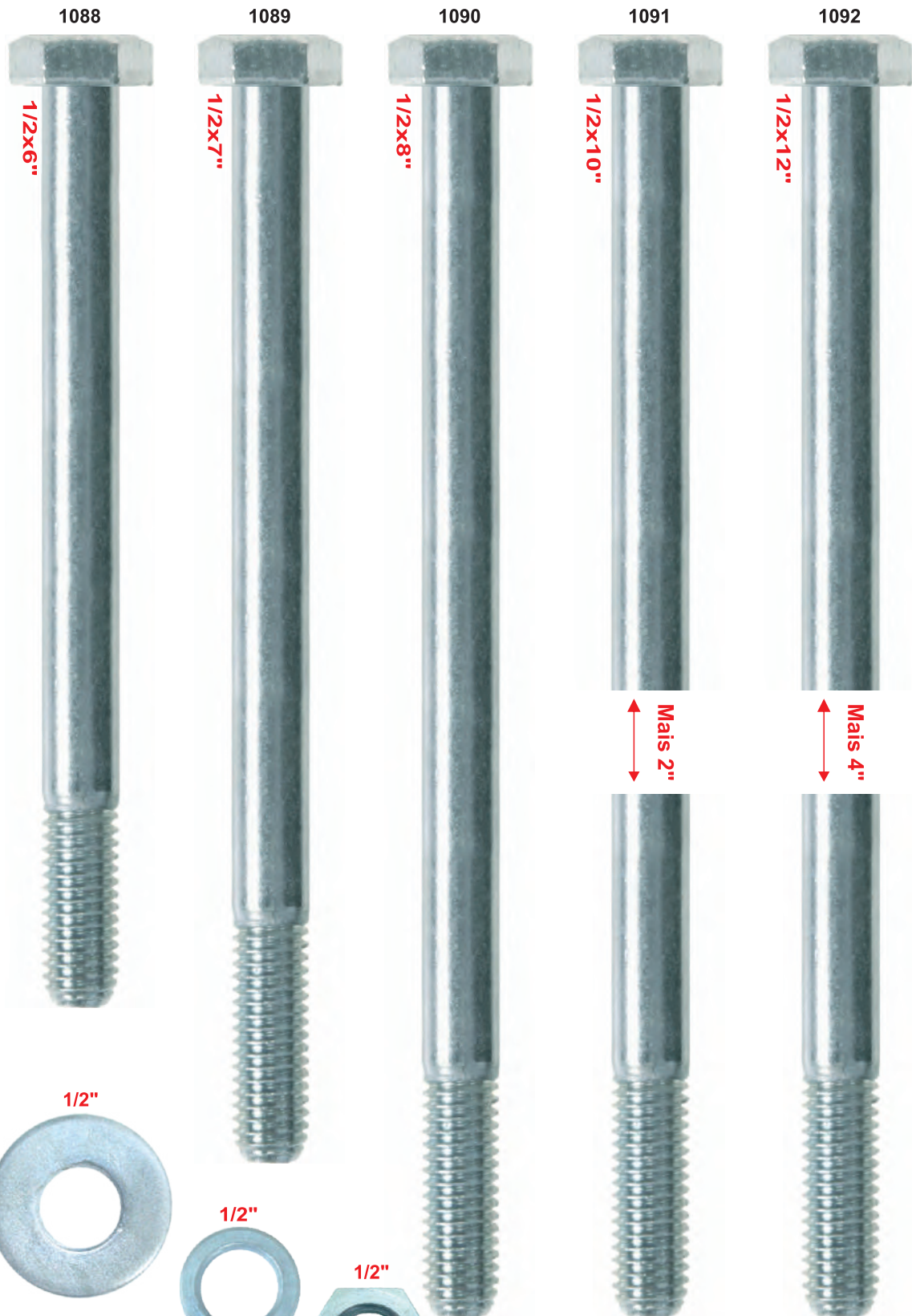

MEDIDA	FIO DE ROSCA	CHAVE
1/2"	13 FIOS	3/4"

1
2
3
4
5
6
7
8
9
10

PARAFUSO SEXTAVADO AÇO GRAU 2 ROSCA GROSSA ZINCADO (UNC) 9/16"

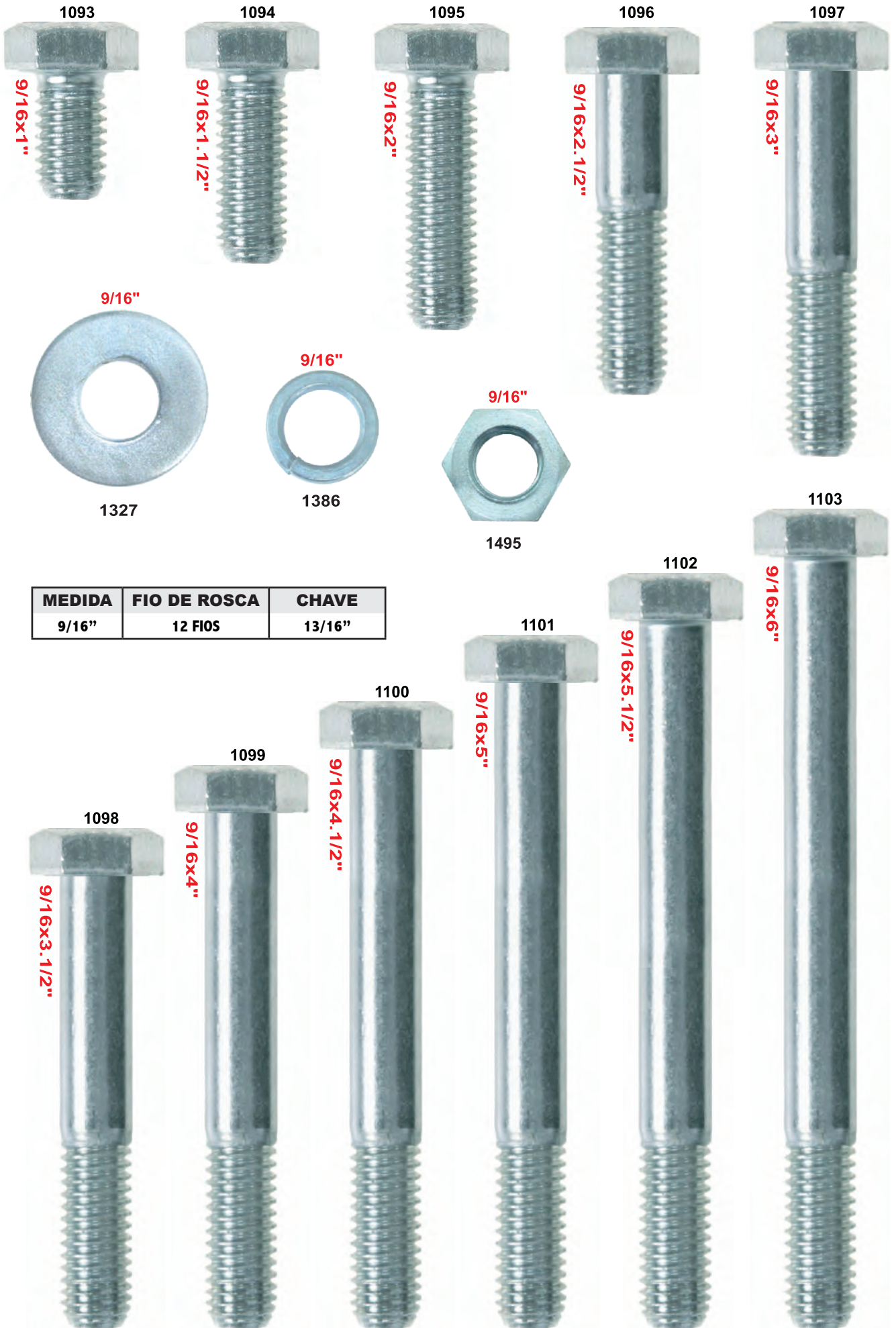

MEDIDA	FIO DE ROSCA	CHAVE
9/16"	12 FIOS	13/16"

1
2
3
4
5
6
7
8
9
10

PARAFUSO SEXTAVADO AÇO GRAU 2 ROSCA GROSSA ZINCADO (UNC) 5/8"

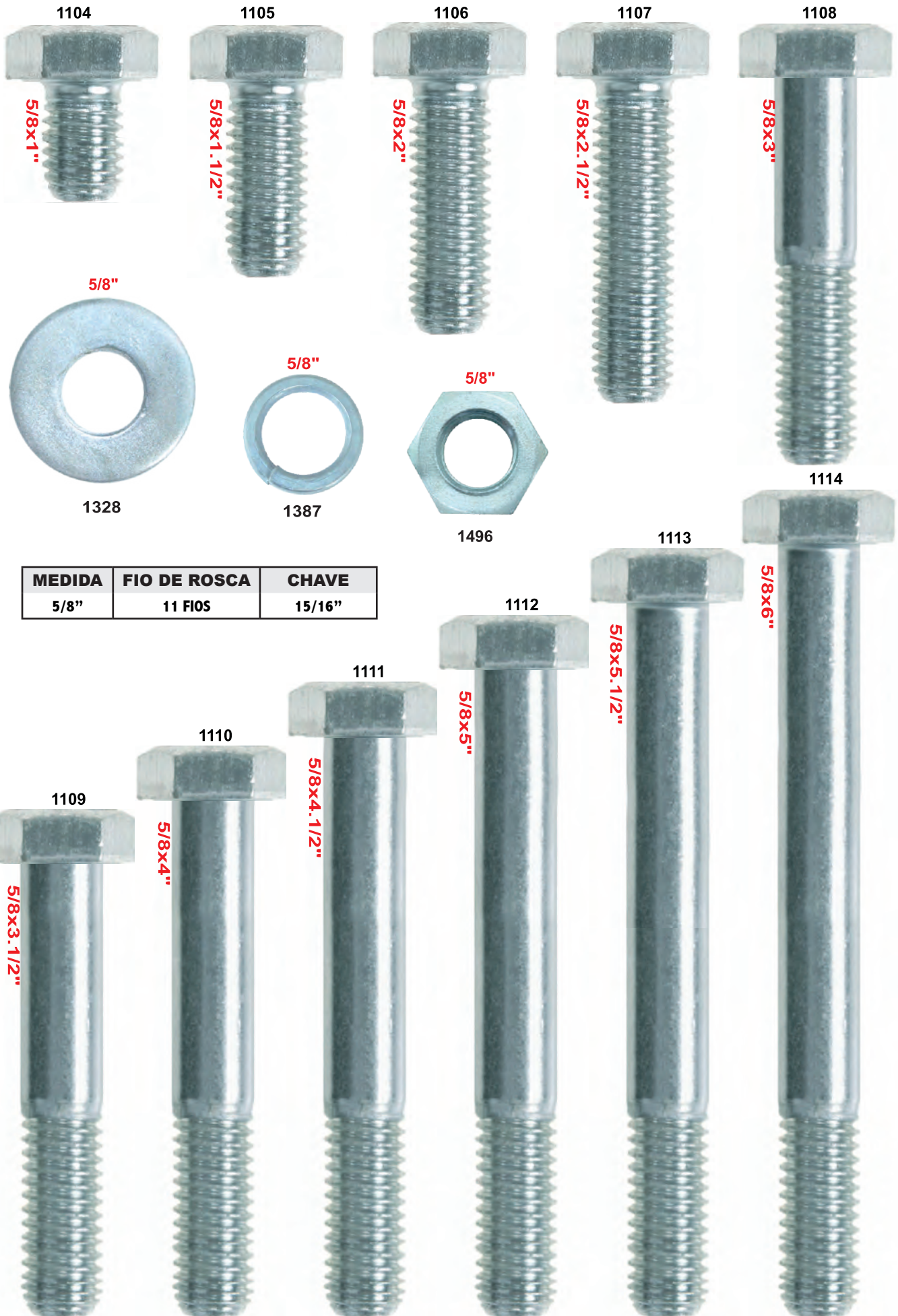

BARRA ROSCADA AÇO 5.8 ROSCA GROSSA POLIDA (UNC)

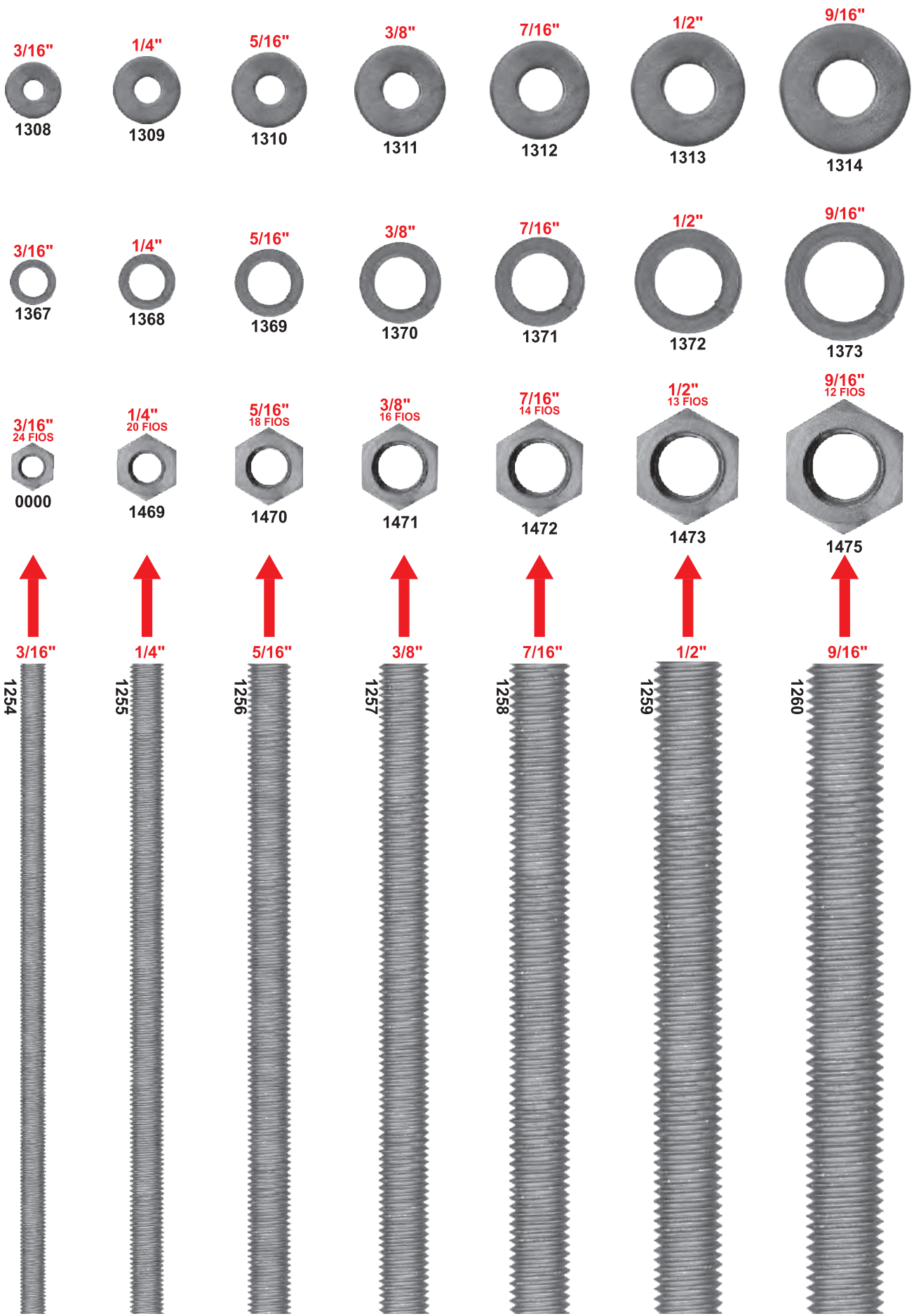

0
1
2
3
4
5
6
7
8
9
10
11
12
13
14
15
16
17
18
19
20
21
22
23
24
25
26
27

BARRA ROSCADA AÇO 5.8 ROSCA GROSSA POLIDA (UNC)



5/8"

1261



3/4"

1262



7/8"

1263



1"

1264



BARRA ROSCADA AÇO 5.8 ROSCA GROSSA ZINCADA (UNC)

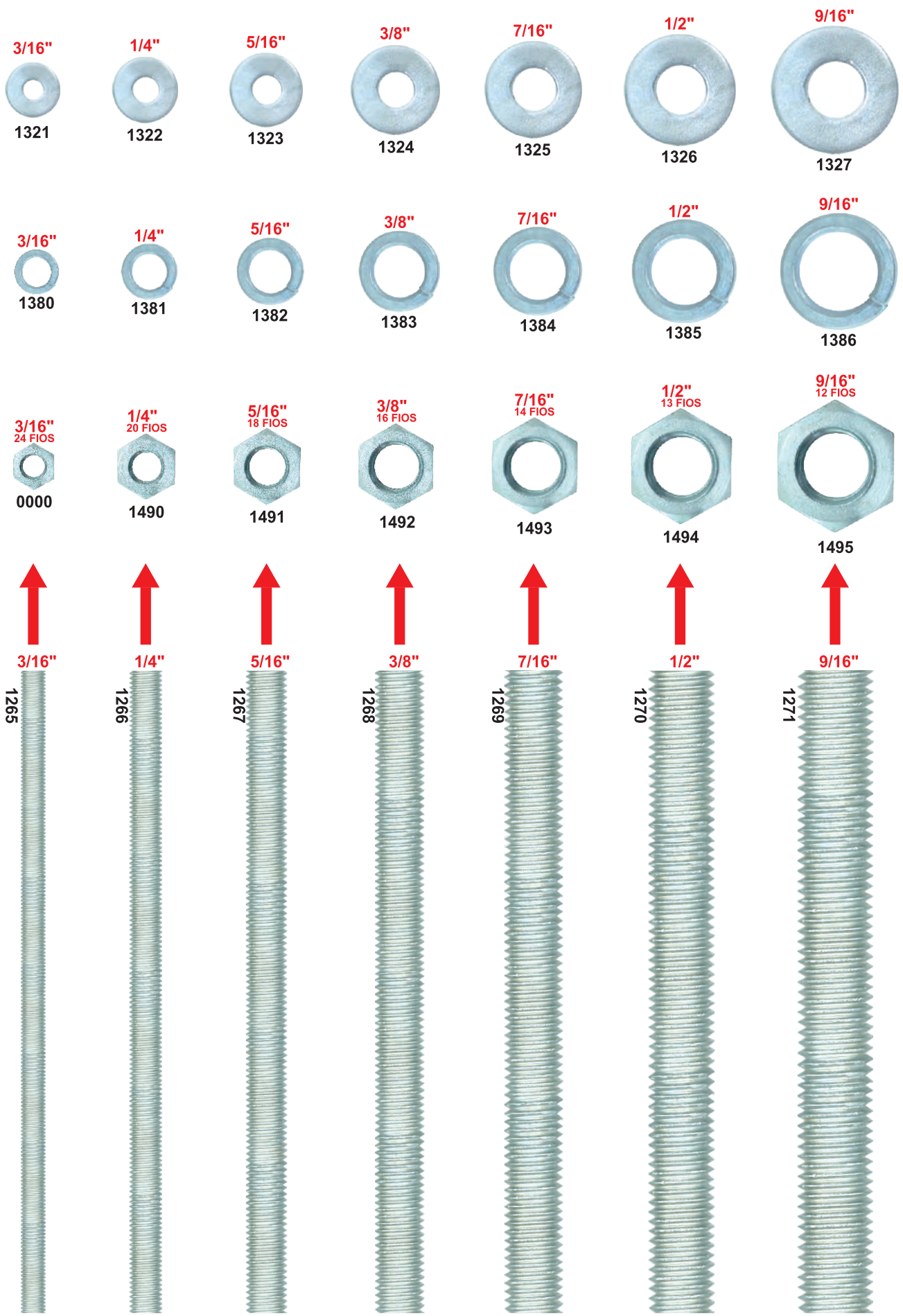

0
1
2
3
4
5
6
7
8
9
10
11
12
13
14
15
16
17
18
19
20
21
22
23
24
25
26
27

BARRA ROSCADA AÇO 5.8 ROSCA GROSSA ZINCADA (UNC)

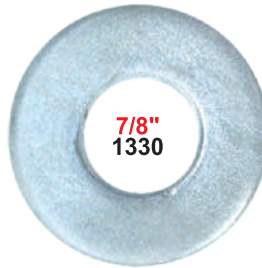

5/8"

1272



3/4"

1273



7/8"

1274



1"

1275



ARRUELA LISA AÇO 5.8 POLIDA POLEGADA

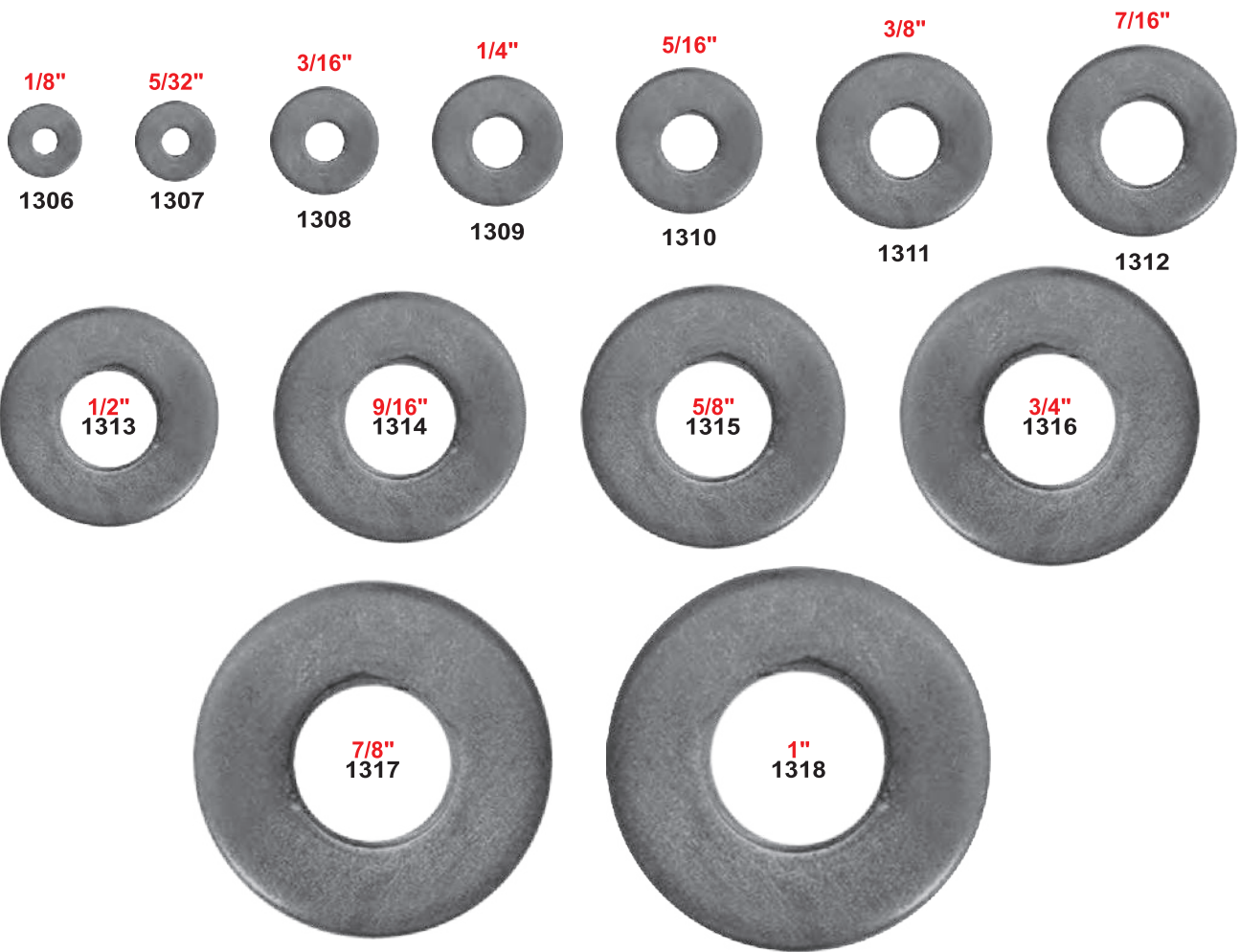

ARRUELA FUNILEIRO AÇO 5.8 ZINCADA POLEGADA

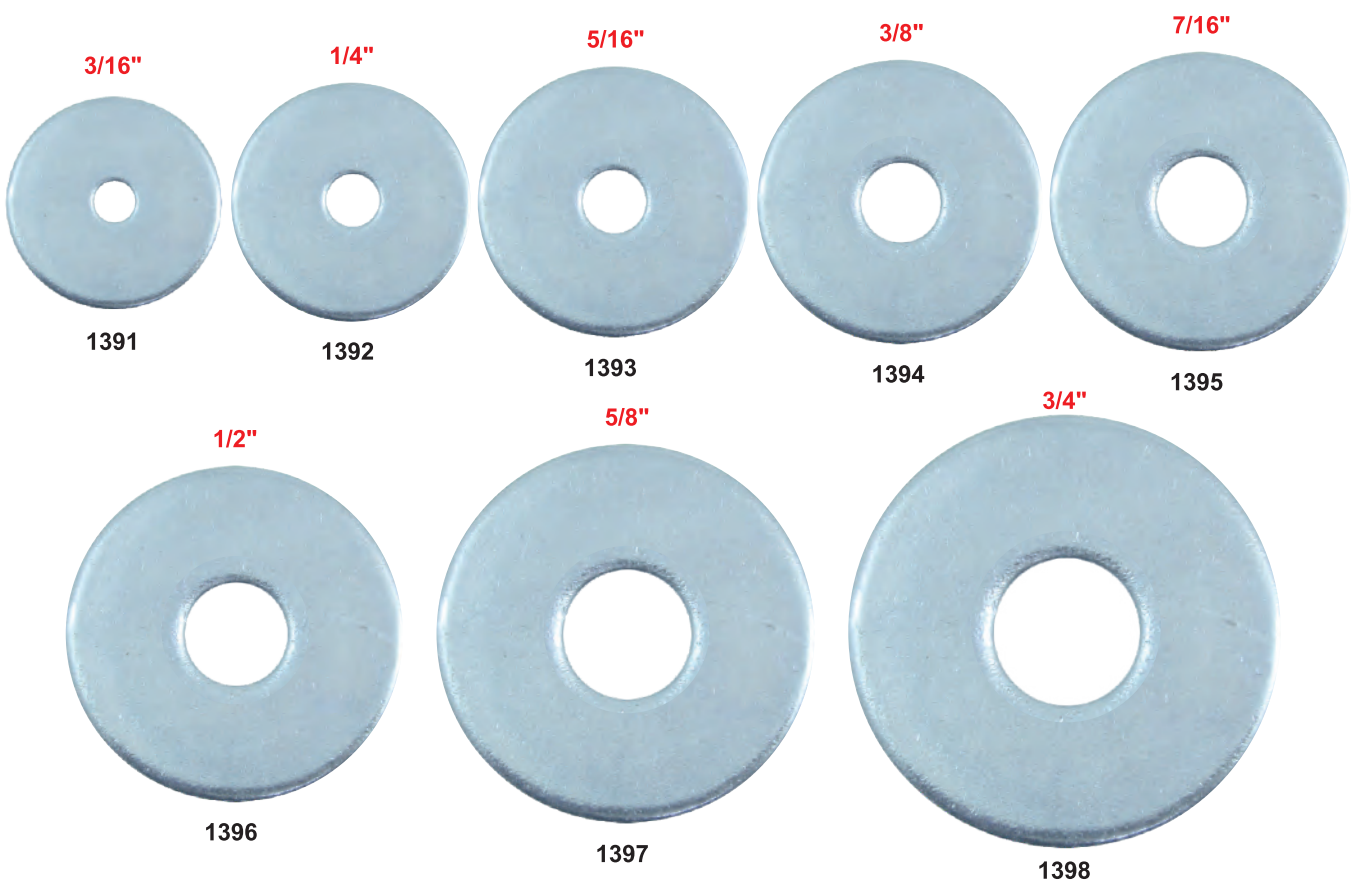

ARRUELA LISA AÇO 5.8 ZINCADA POLEGADA

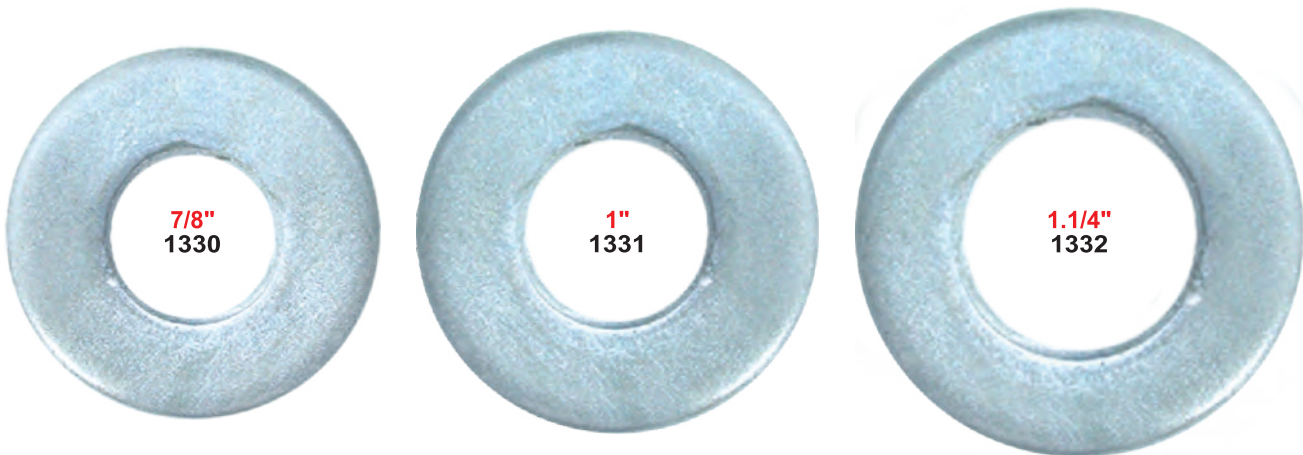
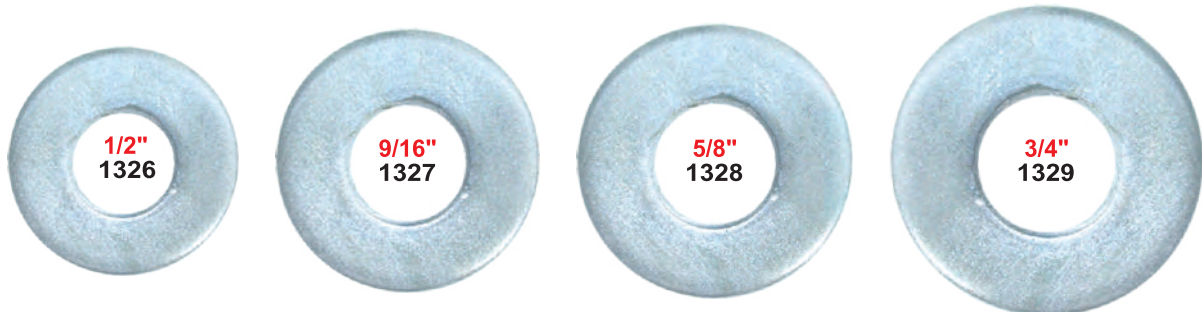

0
1
2
3
4
5
6
7
8
9
10
11
12
13
14
15
16
17
18
19
20
21
22
23
24
25
26
27

ARRUELA DE PRESSÃO AÇO 5.8 POLIDA MILÍMETRO

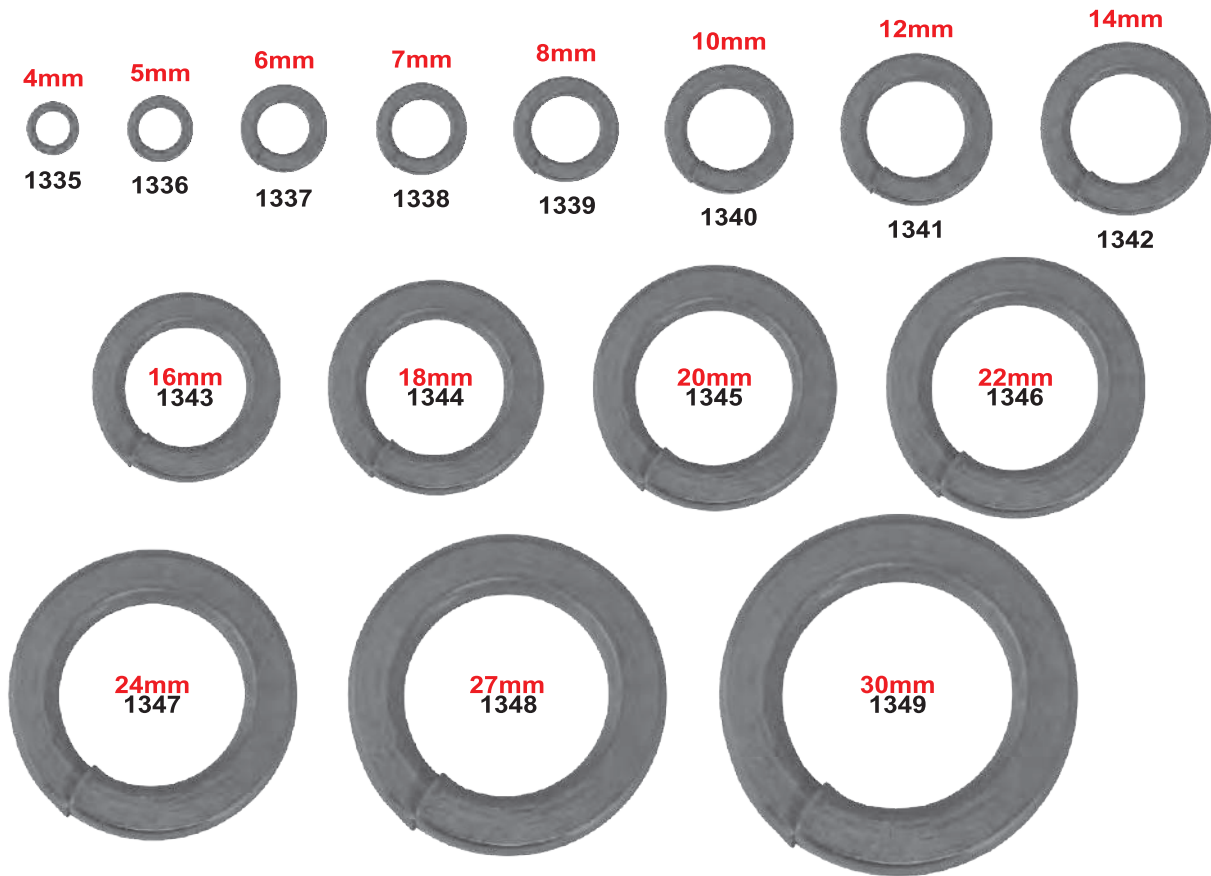

ARRUELA DE PRESSÃO AÇO 5.8 ZINCADA MILÍMETRO

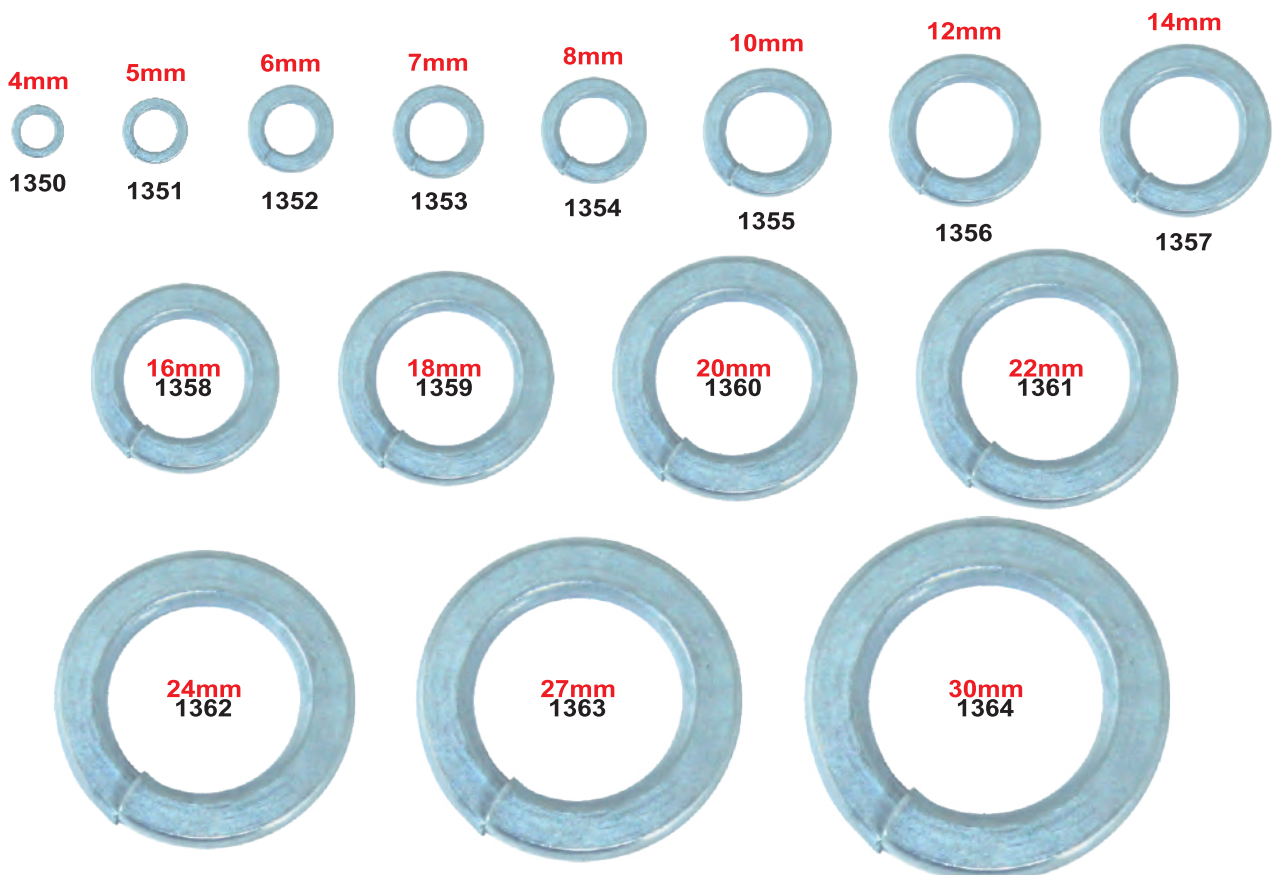

ARRUELA DE PRESSÃO AÇO 5.8 POLIDA POLEGADA

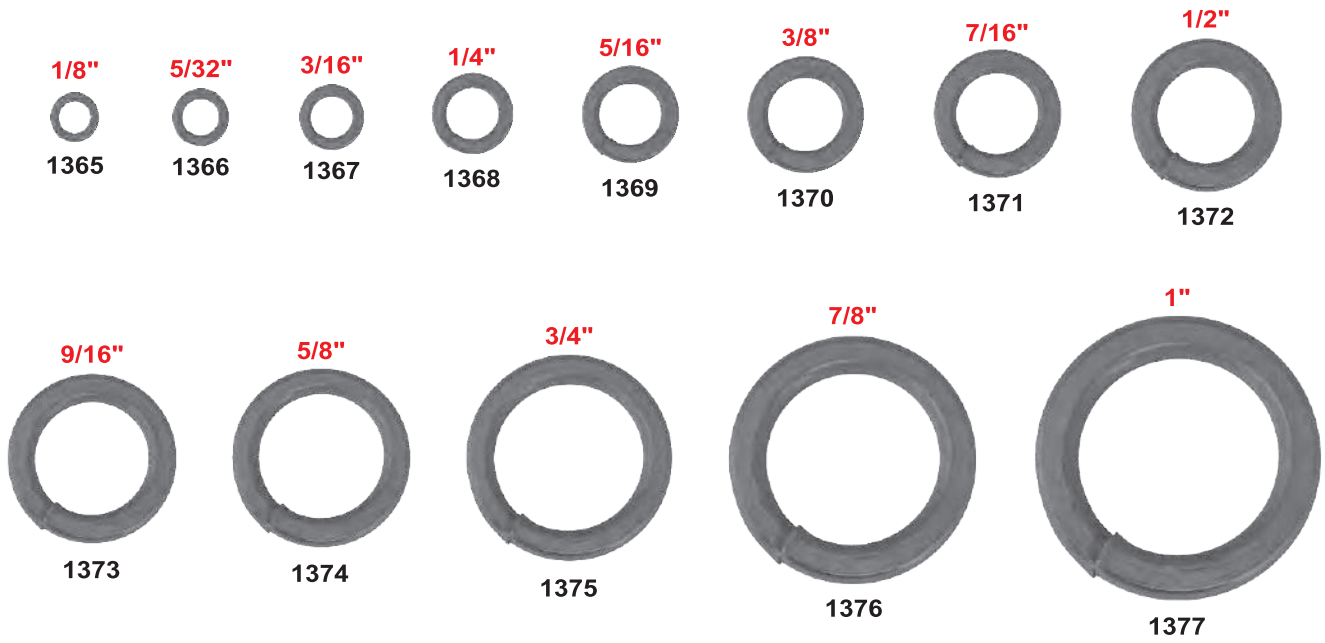

ARRUELA DE PRESSÃO AÇO 5.8 ZINCADA POLEGADA

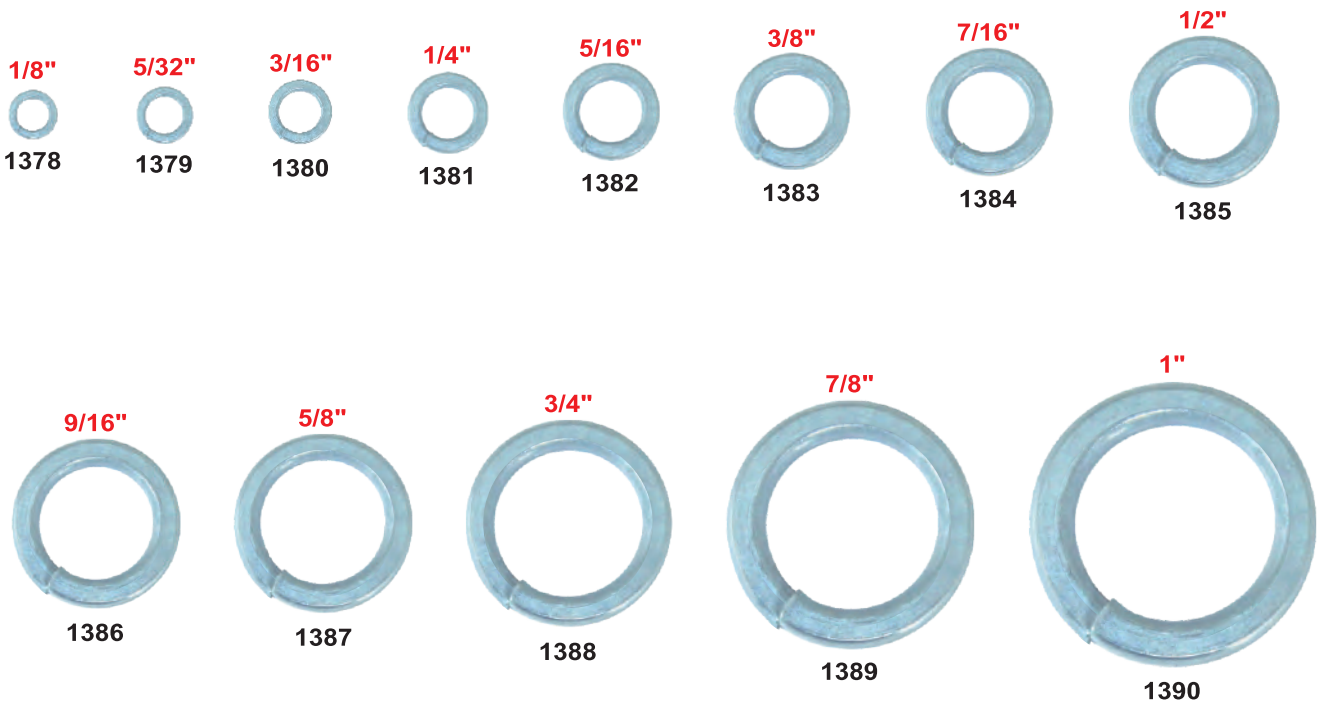

0
1
2
3
4
5
6
7
8
9
10
11
12
13
14
15
16
17
18
19
20
21
22
23
24
25
26
27

PORCA SEXTAVADA AÇO 8.8 ROSCA GROSSA (MA) MILÍMETRO

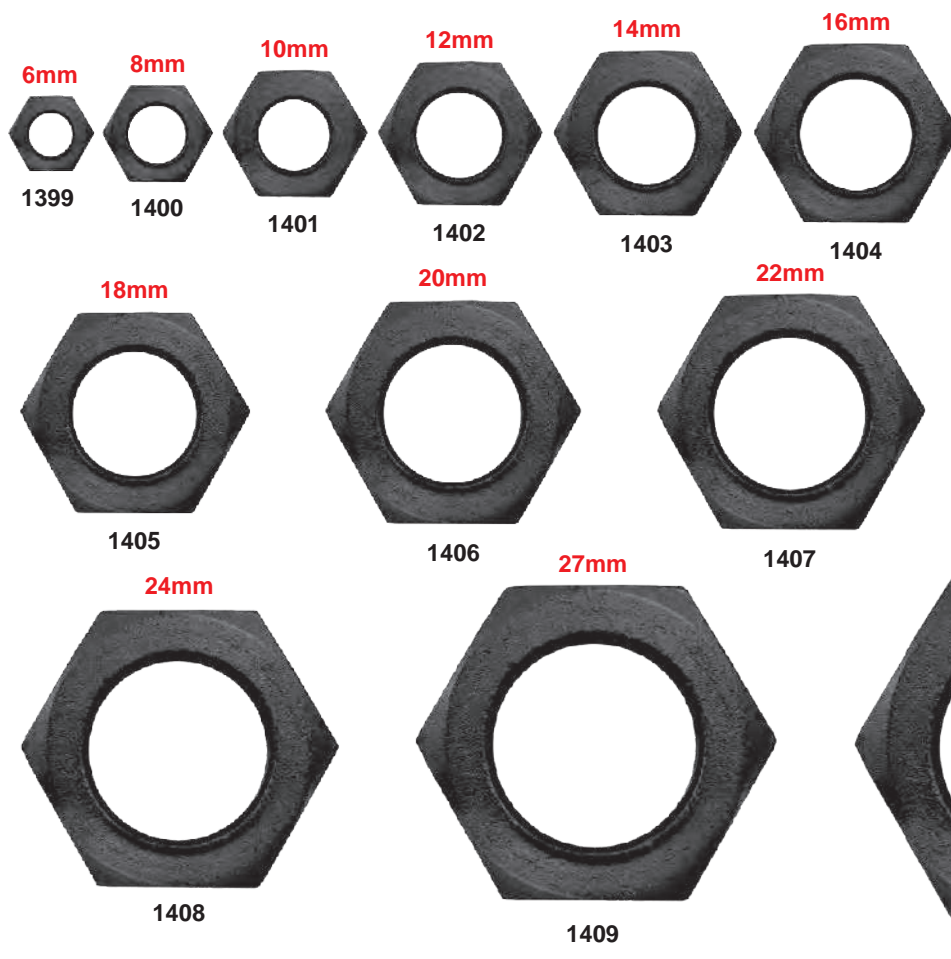

MEDIDA	FIO ROSCA	CHAVE
6MM	1,00	10MM
8MM	1,25	13MM
10MM	1,50	17MM
12MM	1,75	19MM
14MM	2,00	22MM
16MM	2,00	24MM
18MM	2,50	27MM
20MM	2,50	30MM
22MM	2,50	32MM
24MM	3,00	36MM
27MM	3,00	41MM
30MM	3,50	46MM

PORCA SEXTAVADA AÇO 8.8 ROSCA FINA (MB) MILÍMETRO

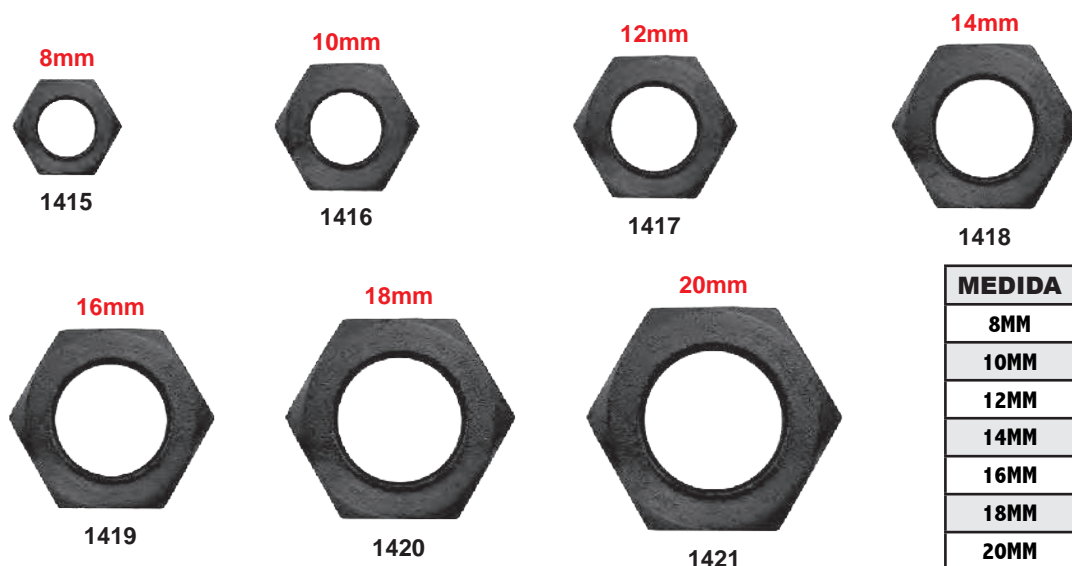

MEDIDA	FIO ROSCA	CHAVE
8MM	1,00	13MM
10MM	1,00	17MM
12MM	1,50	19MM
14MM	1,50	22MM
16MM	1,50	24MM
18MM	1,50	27MM
20MM	1,50	30MM

PORCA SEXTAVADA AÇO 8.8 ROSCA GROSSA (MA) BICROMATIZADA MILÍMETRO

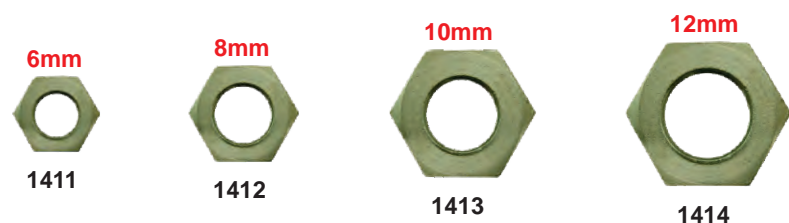

MEDIDA	FIO ROSCA	CHAVE
6MM	1,00	10MM
8MM	1,25	13MM
10MM	1,50	17MM
12MM	1,75	19MM

PORCA SEXTAVADA AÇO 8.8 ROSCA FIAT MILÍMETRO

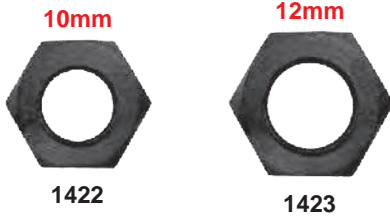

MEDIDA	FIO ROSCA	CHAVE
10MM	1,25	17MM
12MM	1,25	19MM

PORCA SEXTAVADA AÇO 10.9 ROSCA GROSSA (MA) MILÍMETRO

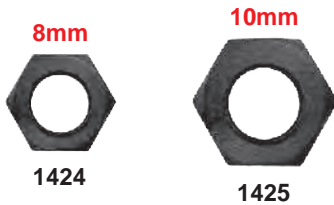

MEDIDA	FIO ROSCA	CHAVE
8MM	1,25	13MM
10MM	1,50	17MM

PORCA SEXTAVADA AÇO 10.9 ROSCA FINA (MB) MILÍMETRO

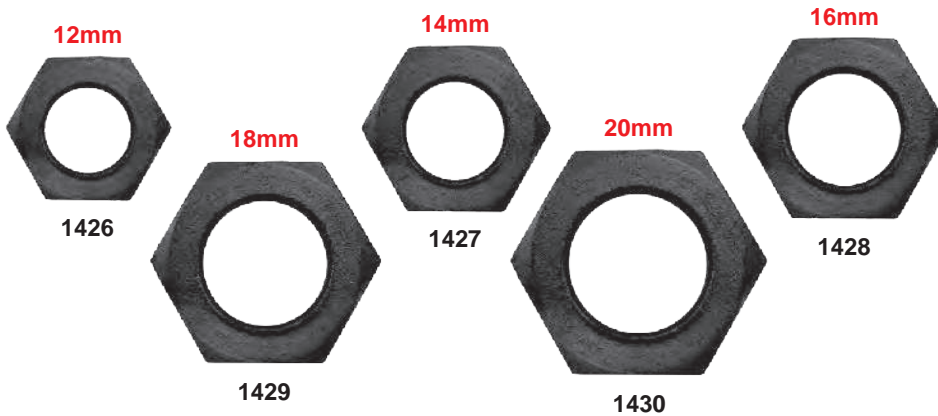

MEDIDA	FIO ROSCA	CHAVE
12MM	1,50	19MM
14MM	1,50	22MM
16MM	1,50	24MM
18MM	1,50	27MM
20MM	1,50	30MM

PORCA SEXTAVADA AÇO GRAU 5 ROSCA GROSSA (UNC) POLEGADA

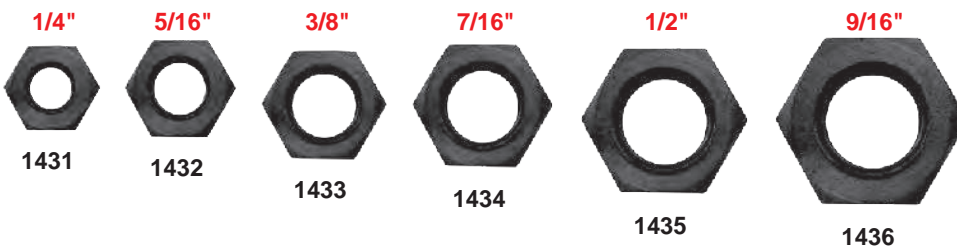

MEDIDA	FIO ROSCA	CHAVE
1/4"	20 FIOS	7/16"
5/16"	18 FIOS	1/2"
3/8"	16 FIOS	9/16"
7/16"	14 FIOS	5/8"
1/2"	13 FIOS	3/4"
9/16"	12 FIOS	7/8"
5/8"	11 FIOS	15/16"
3/4"	10 FIOS	1.1/8"
7/8"	9 FIOS	1.5/16"
1"	8 FIOS	1.1/2"

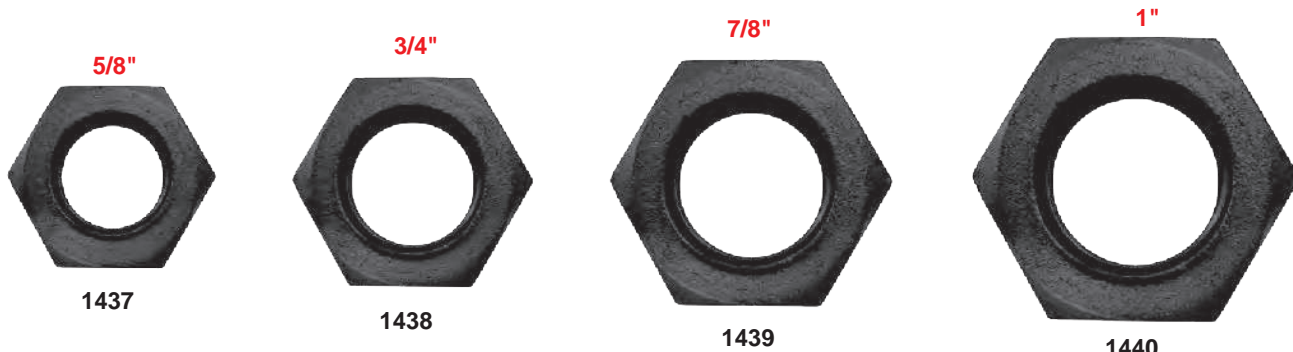

PORCA SEXTAVADA AÇO GRAU 5 ROSCA FINA (UNF) POLEGADA

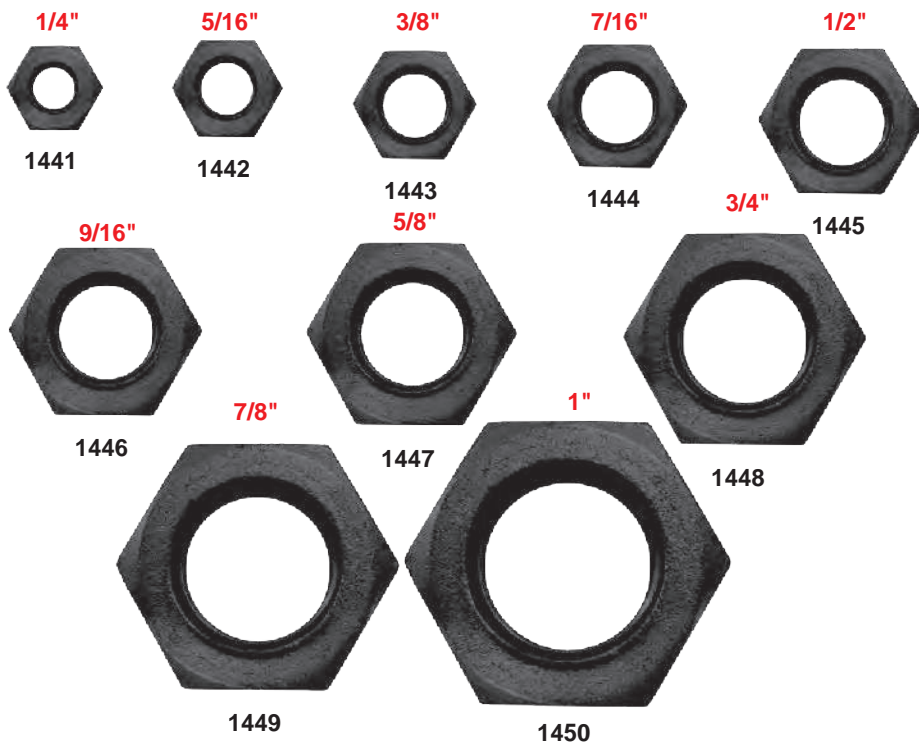

MEDIDA	FIO ROSCA	CHAVE
1/4"	28 FIOS	7/16"
5/16"	24 FIOS	1/2"
3/8"	24 FIOS	9/16"
7/16"	20 FIOS	5/8"
1/2"	20 FIOS	3/4"
9/16"	18 FIOS	7/8"
5/8"	18 FIOS	15/16"
3/4"	16 FIOS	1.1/8"
7/8"	14 FIOS	1.5/16"
1"	12 FIOS	1.1/2"

PORCA SEXTAVADA AÇO 5.8 ROSCA GROSSA (MA) ZINCADA MILÍMETRO

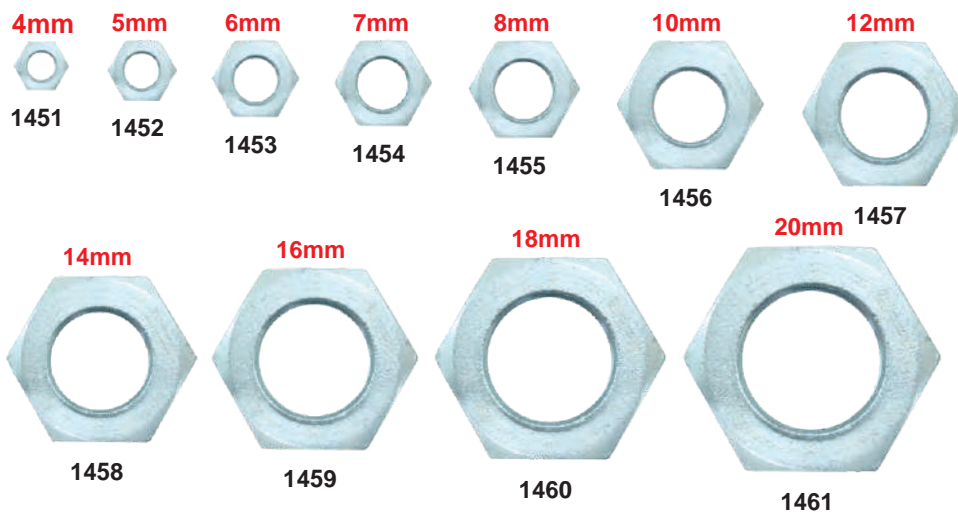

MEDIDA	FIO ROSCA	CHAVE
4MM	0,70	7MM
5MM	0,80	8MM
6MM	1,00	10MM
7MM	1,00	11MM
8MM	1,25	13MM
10MM	1,50	17MM
12MM	1,75	19MM
14MM	2,00	22MM
16MM	2,00	24MM
18MM	2,50	27MM
20MM	2,50	30MM

PORCA SEXTAVADA AÇO 5.8 ROSCA FINA (MB) ZINCADA MILÍMETRO

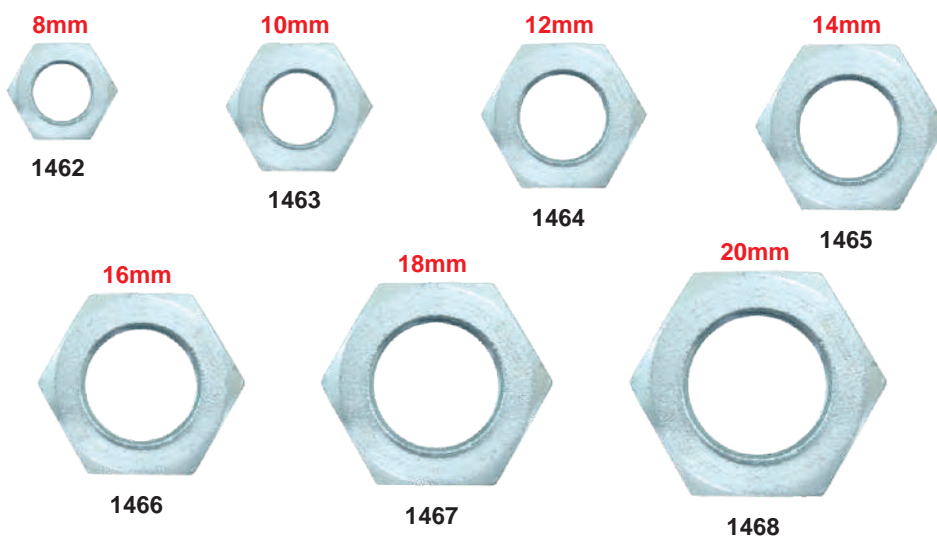

MEDIDA	FIO ROSCA	CHAVE
8MM	1,00	13MM
10MM	1,00	17MM
12MM	1,50	19MM
14MM	1,50	22MM
16MM	1,50	24MM
18MM	1,50	27MM
20MM	1,50	30MM

PORCA SEXTAVADA AÇO GRAU 2 ROSCA GROSSA (UNC) POLEGADA

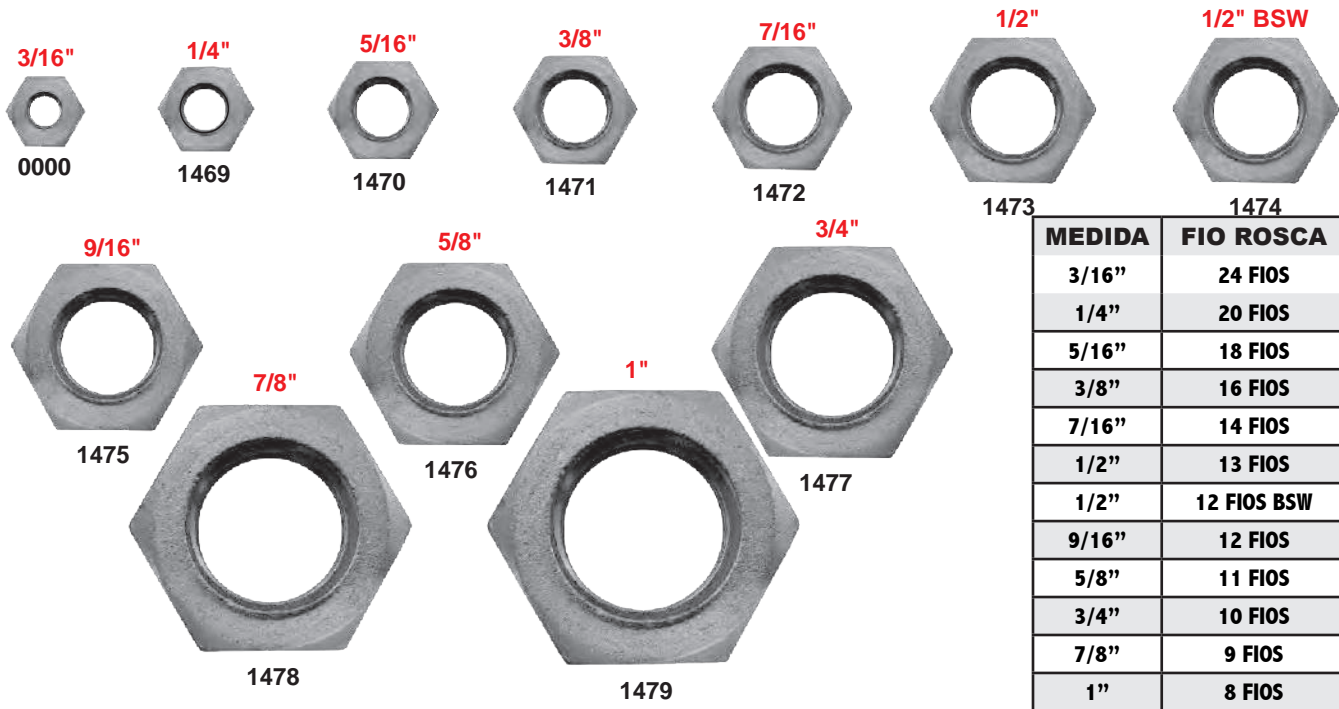

MEDIDA	FIO ROSCA	CHAVE
3/16"	24 FIOS	5/16"
1/4"	20 FIOS	7/16"
5/16"	18 FIOS	1/2"
3/8"	16 FIOS	9/16"
7/16"	14 FIOS	5/8"
1/2"	13 FIOS	3/4"
1/2"	12 FIOS BSW	3/4"
9/16"	12 FIOS	7/8"
5/8"	11 FIOS	15/16"
3/4"	10 FIOS	1.1/8"
7/8"	9 FIOS	1.5/16"
1"	8 FIOS	1.1/2"

PORCA SEXTAVADA AÇO GRAU 2 ROSCA FINA (UNF) POLEGADA

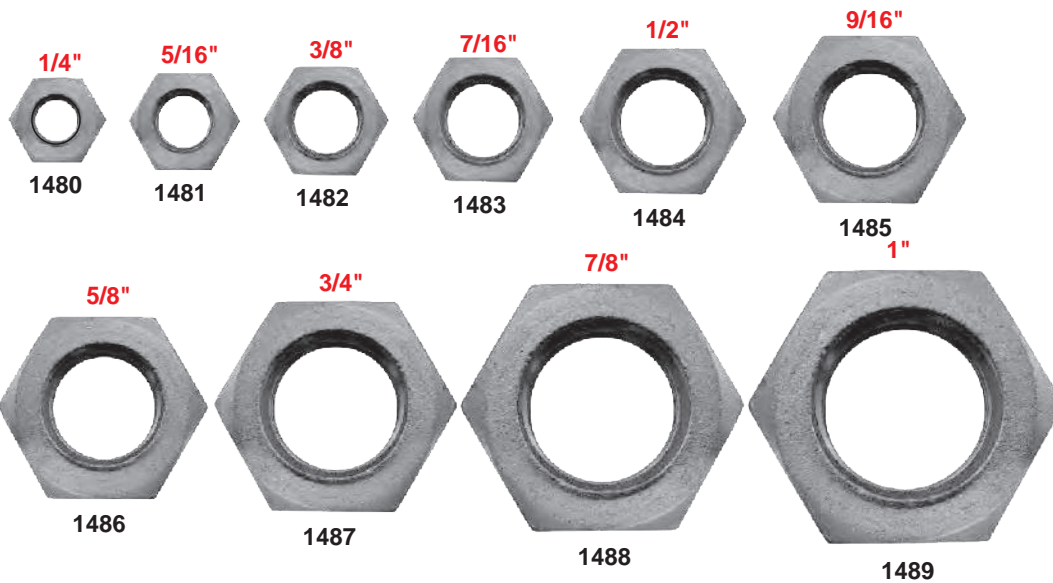

MEDIDA	FIO ROSCA	CHAVE
1/4"	28 FIOS	7/16"
5/16"	24 FIOS	1/2"
3/8"	24 FIOS	9/16"
7/16"	20 FIOS	5/8"
1/2"	20 FIOS	3/4"
9/16"	18 FIOS	7/8"
5/8"	18 FIOS	15/16"
3/4"	16 FIOS	1.1/8"
7/8"	14 FIOS	1.5/16"
1"	12 FIOS	1.1/2"

PORCA SEXTAVADA AÇO GRAU 2 ROSCA FINA (UNF) ZINCADA POLEGADA

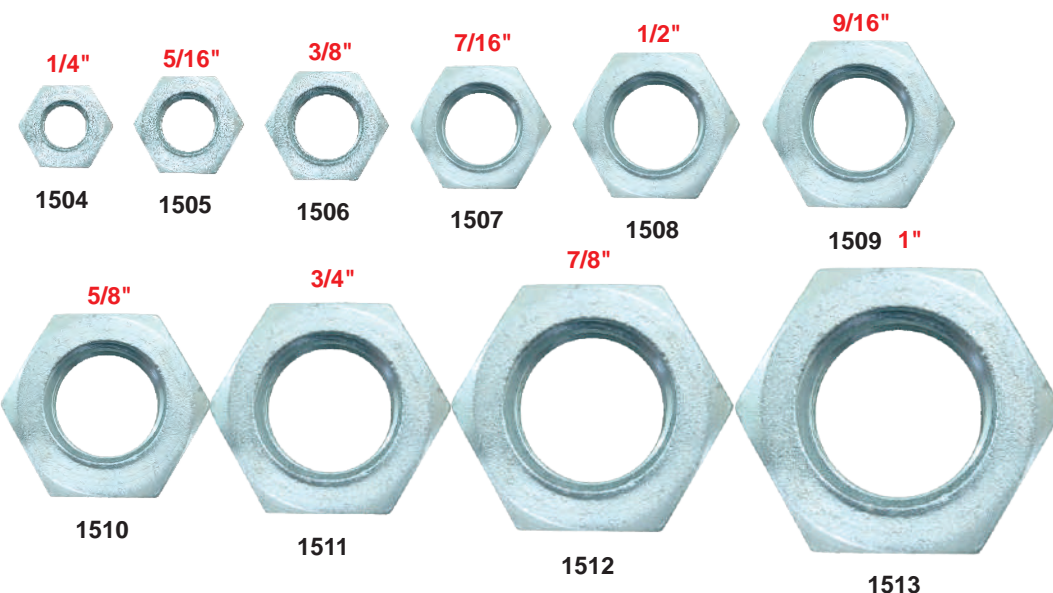

MEDIDA	FIO ROSCA	CHAVE
1/4"	28 FIOS	7/16"
5/16"	24 FIOS	1/2"
3/8"	24 FIOS	9/16"
7/16"	20 FIOS	5/8"
1/2"	20 FIOS	3/4"
9/16"	18 FIOS	7/8"
5/8"	18 FIOS	15/16"
3/4"	16 FIOS	1.1/8"
7/8"	14 FIOS	1.5/16"
1"	12 FIOS	1.1/2"

PORCA SEXTAVADA AÇO GRAU 2 ROSCA GROSSA (UNC) ZINCADA POLEGADA

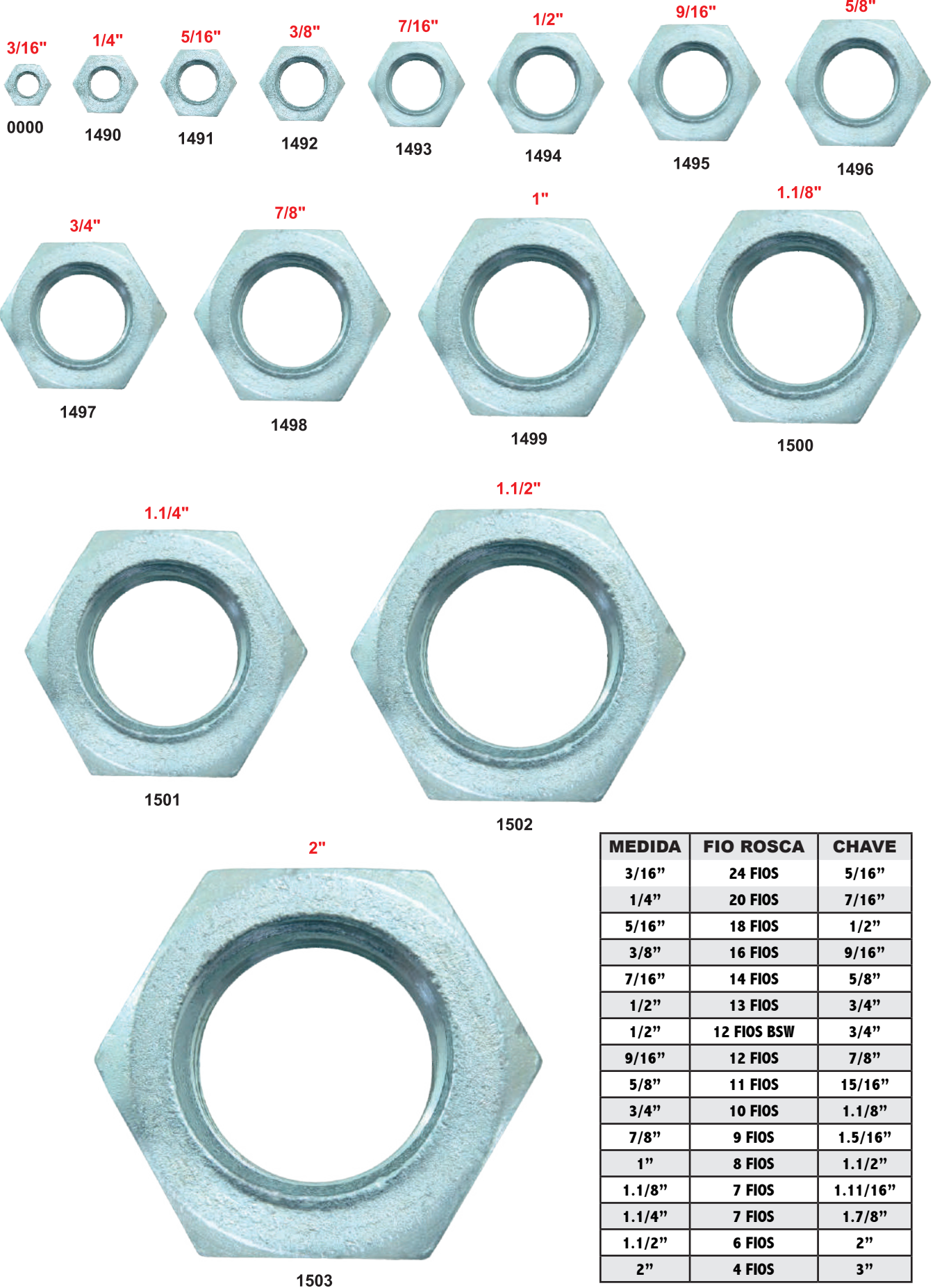

MEDIDA	FIO ROSCA	CHAVE
3/16"	24 FIOS	5/16"
1/4"	20 FIOS	7/16"
5/16"	18 FIOS	1/2"
3/8"	16 FIOS	9/16"
7/16"	14 FIOS	5/8"
1/2"	13 FIOS	3/4"
1/2"	12 FIOS BSW	3/4"
9/16"	12 FIOS	7/8"
5/8"	11 FIOS	15/16"
3/4"	10 FIOS	1.1/8"
7/8"	9 FIOS	1.5/16"
1"	8 FIOS	1.1/2"
1.1/8"	7 FIOS	1.11/16"
1.1/4"	7 FIOS	1.7/8"
1.1/2"	6 FIOS	2"
2"	4 FIOS	3"

PORCA SEXTAVADA AUTO TRAVANTE AÇO 8.8 ROSCA GROSSA (MA) MILÍMETRO

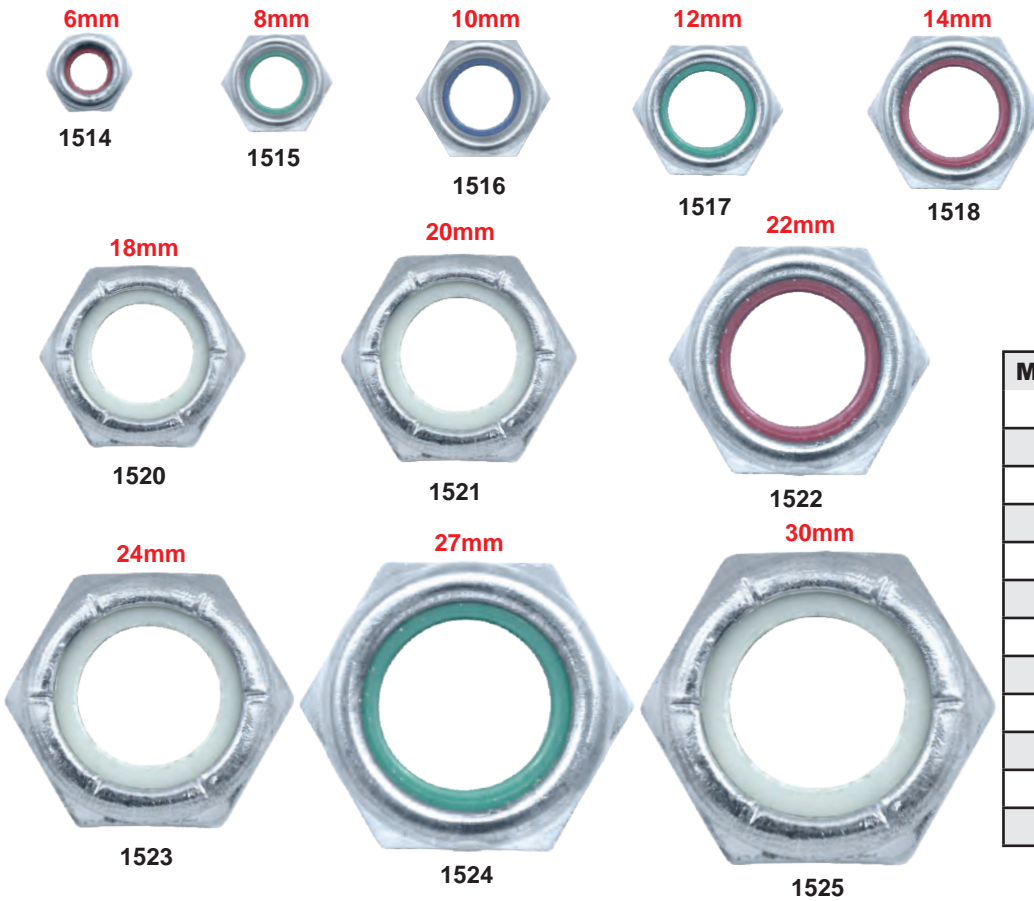

MEDIDA	FIO ROSCA	CHAVE
6MM	1,00	10MM
8MM	1,25	13MM
10MM	1,50	17MM
12MM	1,75	19MM
14MM	2,00	22MM
16MM	2,00	24MM
18MM	2,50	27MM
20MM	2,50	30MM
22MM	2,50	32MM
24MM	3,00	36MM
27MM	3,00	41MM
30MM	3,50	46MM

PORCA SEXTAVADA AUTO TRAVANTE AÇO 8.8 ROSCA FINA (MB) MILÍMETRO

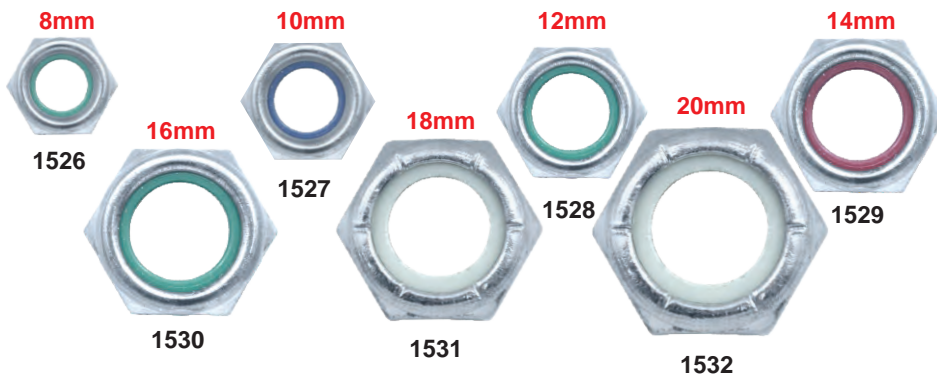

MEDIDA	FIO ROSCA	CHAVE
8MM	1,00	13MM
10MM	1,00	17MM
12MM	1,50	19MM
14MM	1,50	22MM
16MM	1,50	24MM
18MM	1,50	27MM
20MM	1,50	30MM

PORCA SEXT. AUTO TRAVANTE AÇO GRAU 2 ROSCA GROSSA (UNC) POLEGADA

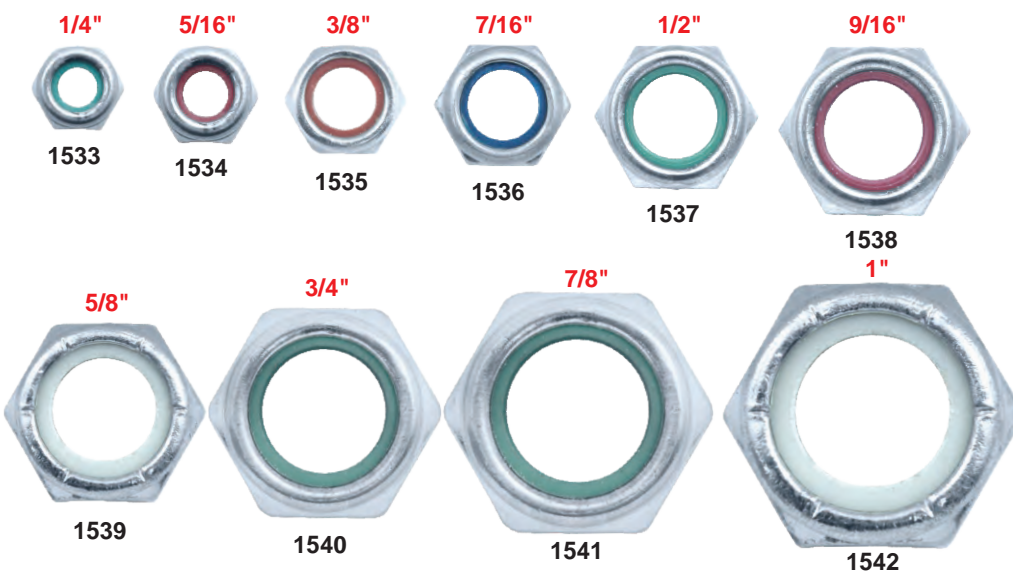

MEDIDA	FIO ROSCA	CHAVE
1/4"	20 FIOS	7/16"
5/16"	18 FIOS	1/2"
3/8"	16 FIOS	9/16"
7/16"	14 FIOS	5/8"
1/2"	13 FIOS	3/4"
9/16"	12 FIOS	7/8"
5/8"	11 FIOS	15/16"
3/4"	10 FIOS	1.1/8"
7/8"	9 FIOS	1.5/16"
1"	8 FIOS	1.1/2"

0
1
2
3
4
5
6
7
8
9
10
11
12
13
14
15
16
17
18
19
20
21
22
23
24
25
26
27

PORCA SEXT. AUTO TRAVANTE AÇO GRAU 2 ROSCA FINA (UNF) POLEGADA

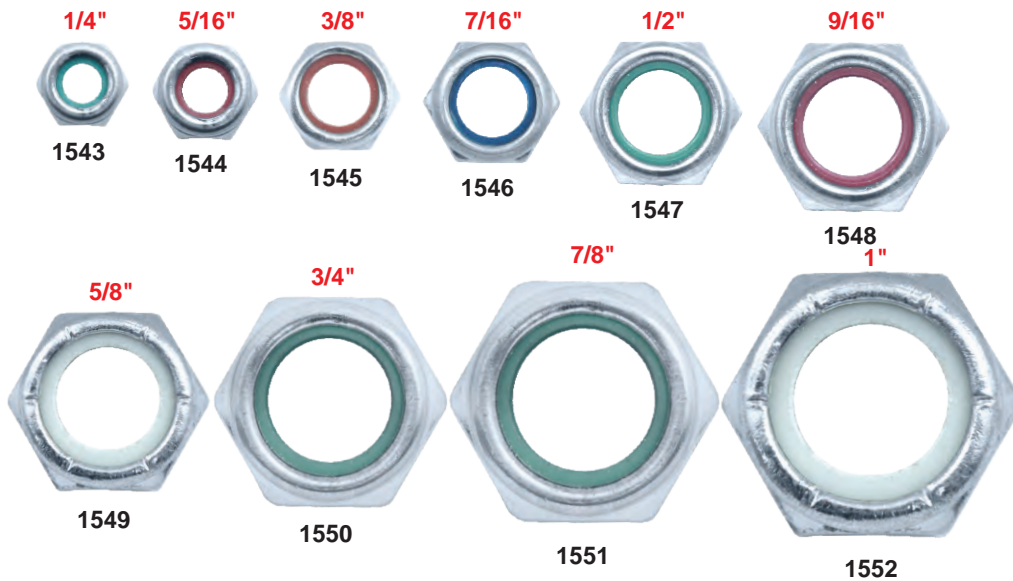

MEDIDA	FIO ROSCA	CHAVE
1/4"	28 FIOS	7/16"
5/16"	24 FIOS	1/2"
3/8"	24 FIOS	9/16"
7/16"	20 FIOS	5/8"
1/2"	20 FIOS	3/4"
9/16"	18 FIOS	7/8"
5/8"	18 FIOS	15/16"
3/4"	16 FIOS	1.1/8"
7/8"	14 FIOS	1.5/16"
1"	12 FIOS	1.1/2"

PORCA SEXTAVADA ALTA DUPLA AÇO 8.8 ROSCA FINA (MB) MILÍMETRO

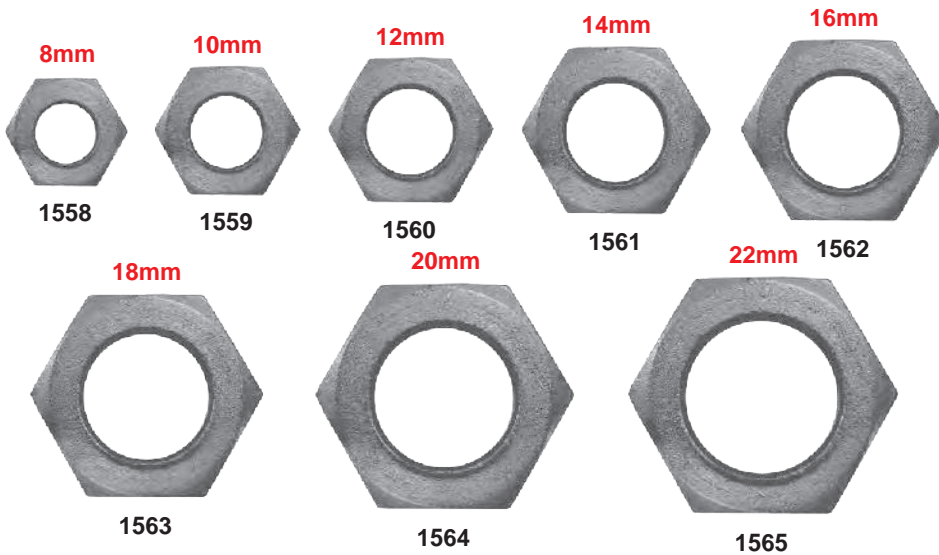

MEDIDA	FIO ROSCA	CHAVE
8MM	1,00	13MM
10MM	1,00	17MM
12MM	1,50	19MM
14MM	1,50	22MM
16MM	1,50	24MM
18MM	1,50	27MM
20MM	1,50	30MM
22MM	1,50	32MM

PORCA SEXTAVADA ALTA DUPLA AÇO GRAU 5 ROSCA FINA (UNF) POLEGADA

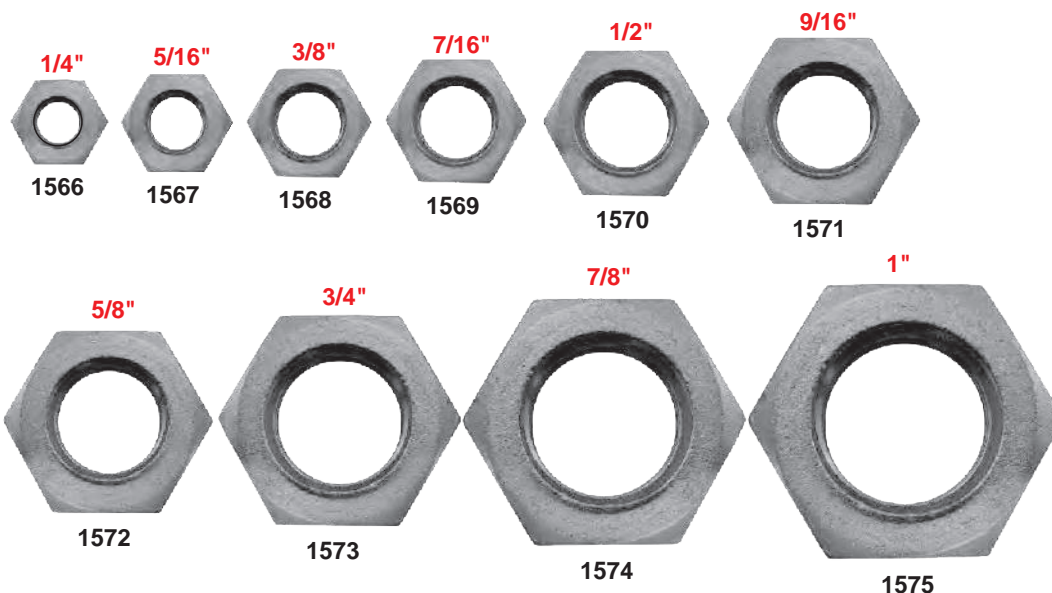

MEDIDA	FIO ROSCA	CHAVE
1/4"	28 FIOS	7/16"
5/16"	24 FIOS	1/2"
3/8"	24 FIOS	9/16"
7/16"	20 FIOS	5/8"
1/2"	20 FIOS	3/4"
9/16"	18 FIOS	7/8"
5/8"	18 FIOS	15/16"
3/4"	16 FIOS	1.1/8"
7/8"	14 FIOS	1.5/16"
1"	12 FIOS	1.1/2"

PORCA SEXTAVADA COM FLANGE AÇO 5.8 ROSCA GROSSA (MA) MILÍMETRO

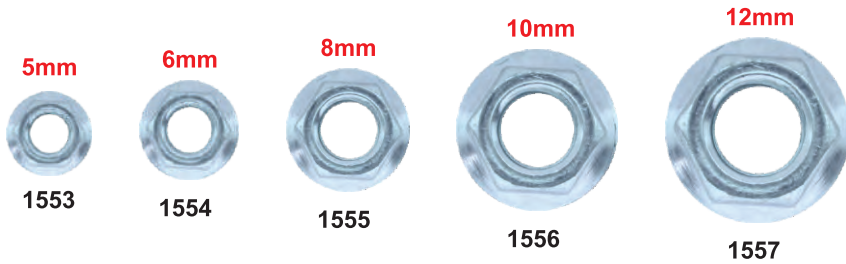

MEDIDA	FIO ROSCA	CHAVE
5MM	0,80	8MM
6MM	1,00	10MM
8MM	1,25	13MM
10MM	1,50	17MM
12MM	1,75	19MM

PORCA SEXTAVADA ESTAMPADA ROSCA GROSSA (UNC) POLEGADA

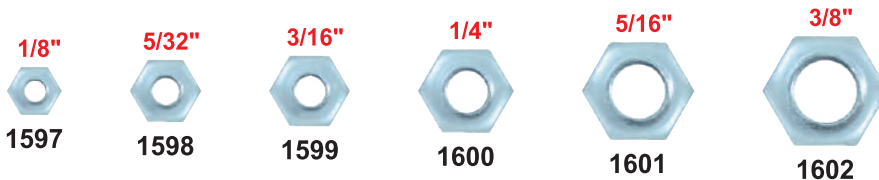

MEDIDA	FIO ROSCA	CHAVE
1/8"	40 FIOS	1/4"
5/32"	32 FIOS	5/16"
3/16"	24 FIOS	3/8"
1/4"	20 FIOS	7/16"
5/16"	18 FIOS	1/2"
3/8"	16 FIOS	9/16"

PORCA SEXTAVADA TORQUE ROSCA GROSSA (MA) MILÍMETRO

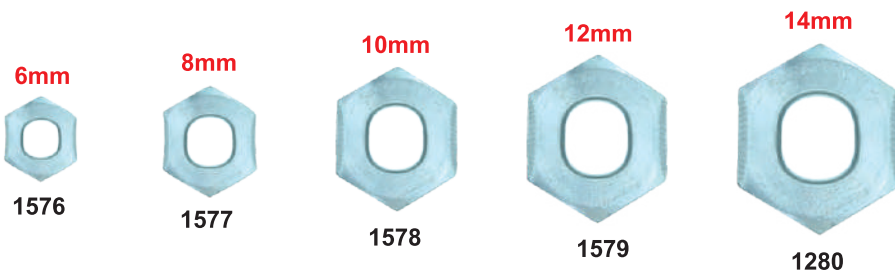

MEDIDA	FIO ROSCA	CHAVE
6MM	1,00	10MM
8MM	1,25	13MM
10MM	1,50	17MM
12MM	1,75	19MM
14MM	2,00	22MM

PORCA SEXTAVADA TORQUE ROSCA FINA (MB) MILÍMETRO

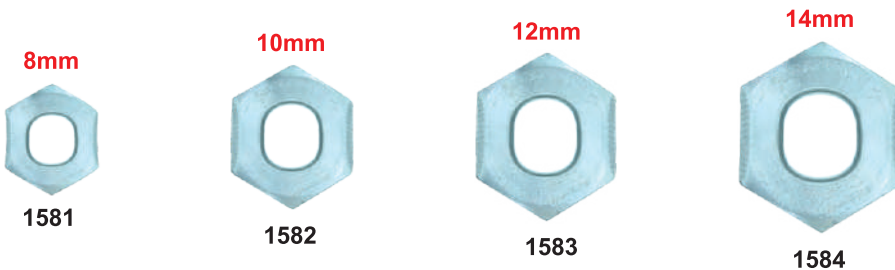

MEDIDA	FIO ROSCA	CHAVE
8MM	1,00	13MM
10MM	1,00	17MM
12MM	1,50	19MM
14MM	1,50	22MM

PORCA SEXTAVADA TORQUE ROSCA GROSSA (UNC) POLEGADA

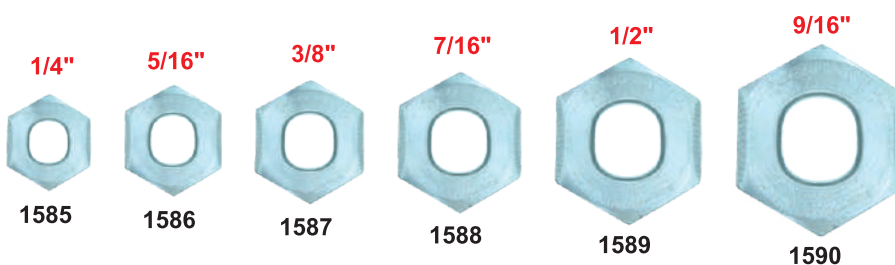

MEDIDA	FIO ROSCA	CHAVE
1/4"	20 FIOS	7/16"
5/16"	18 FIOS	1/2"
3/8"	16 FIOS	9/16"
7/16"	14 FIOS	5/8"
1/2"	13 FIOS	3/4"
9/16"	12 FIOS	7/8"

PORCA SEXTAVADA TORQUE ROSCA FINA (UNF) POLEGADA

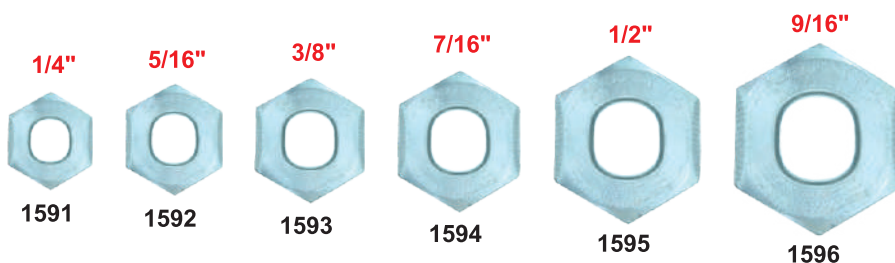

MEDIDA	FIO ROSCA	CHAVE
1/4"	28 FIOS	7/16"
5/16"	24 FIOS	1/2"
3/8"	24 FIOS	9/16"
7/16"	20 FIOS	5/8"
1/2"	20 FIOS	3/4"
9/16"	18 FIOS	7/8"

PORCA BORBOLETA ROSCA ROSCA GROSSA (UNC) POLEGADA

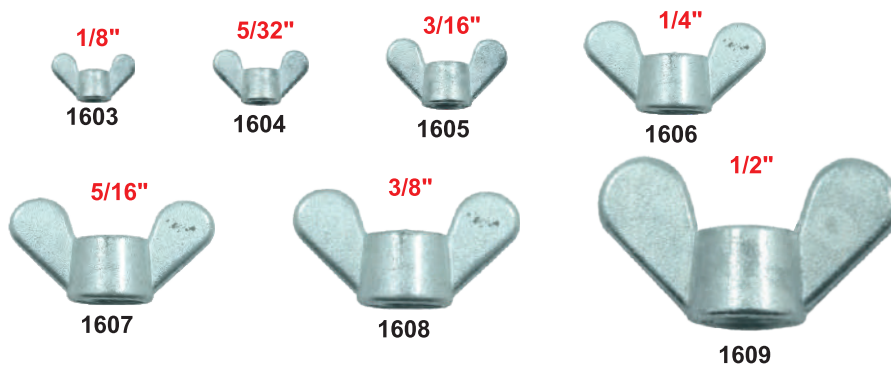

MEDIDA	FIO ROSCA
1/8"	40 FIOS
5/32"	32 FIOS
3/16"	24 FIOS
1/4"	20 FIOS
5/16"	18 FIOS
3/8"	16 FIOS
1/2"	13 FIOS

PORCA CASTELO SEM COROA ROSCA FINA (UNF) POLEGADA

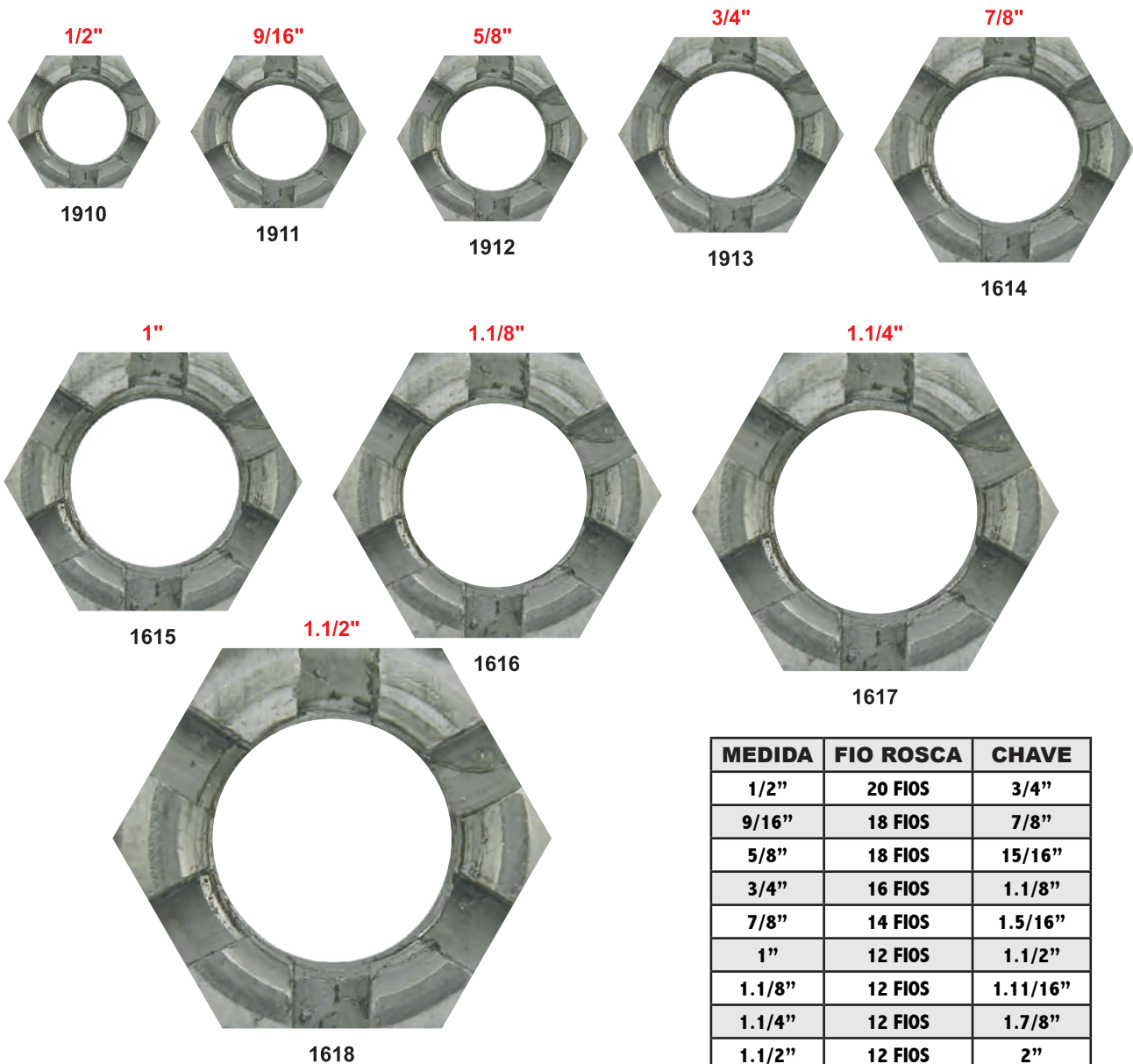

MEDIDA	FIO ROSCA	CHAVE
1/2"	20 FIOS	3/4"
9/16"	18 FIOS	7/8"
5/8"	18 FIOS	15/16"
3/4"	16 FIOS	1.1/8"
7/8"	14 FIOS	1.5/16"
1"	12 FIOS	1.1/2"
1.1/8"	12 FIOS	1.11/16"
1.1/4"	12 FIOS	1.7/8"
1.1/2"	12 FIOS	2"

PARAFUSO FRANCES COM PORCA ROSCA GROSSA (BSW) ZINCADO 3/16"

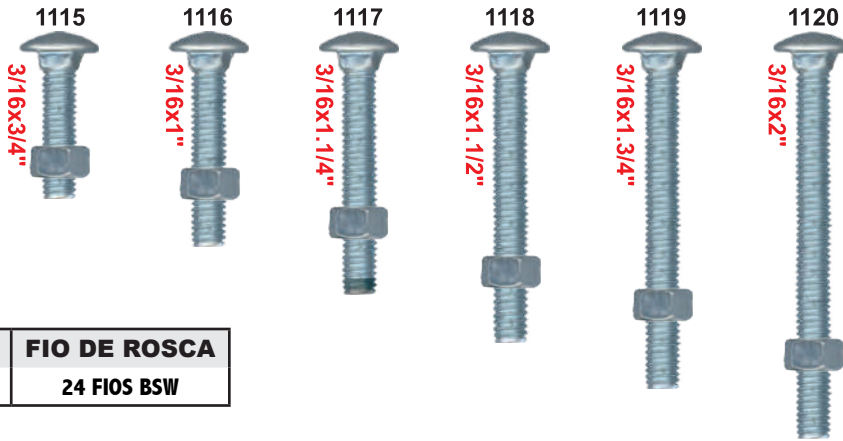

MEDIDA	FIO DE ROSCA
3/16"	24 FIOS BSW

PARAFUSO FRANCES COM PORCA ROSCA GROSSA (UNC) ZINCADO 1/4"

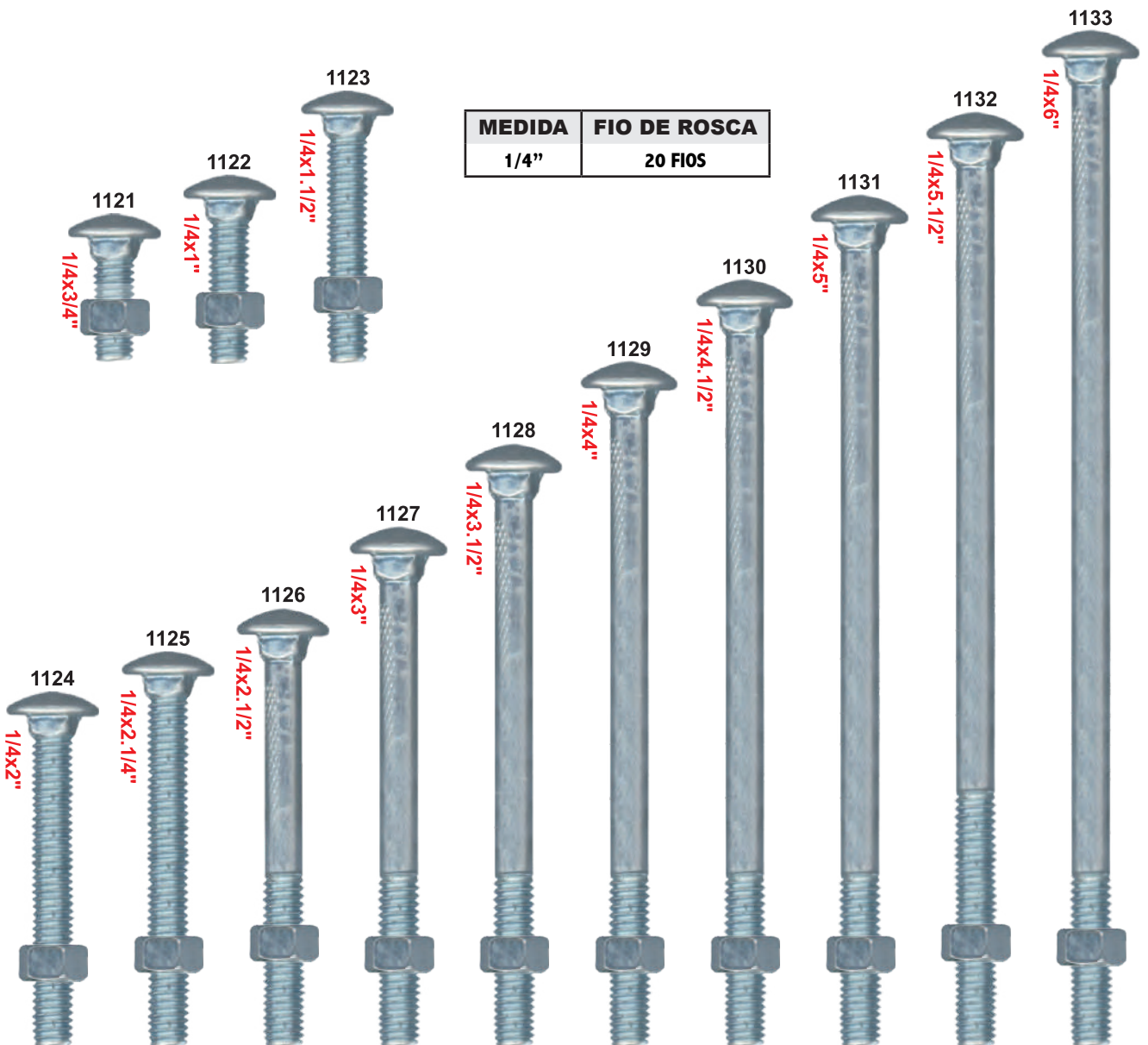

MEDIDA	FIO DE ROSCA
1/4"	20 FIOS

0
1
2
3
4
5
6
7
8
9
10
11
12
13
14
15
16
17
18
19
20
21
22
23
24
25
26
27

PARAFUSO FRANCES COM PORCA ROSCA GROSSA (UNC) ZINCADO 5/16"



MEDIDA	FIO DE ROSCA
5/16"	18 FIOS



PARAFUSO FRANCES COM PORCA ROSCA GROSSA (UNC) ZINCADO 5/16"

MEDIDA	FIO DE ROSCA
5/16"	18 FIOS

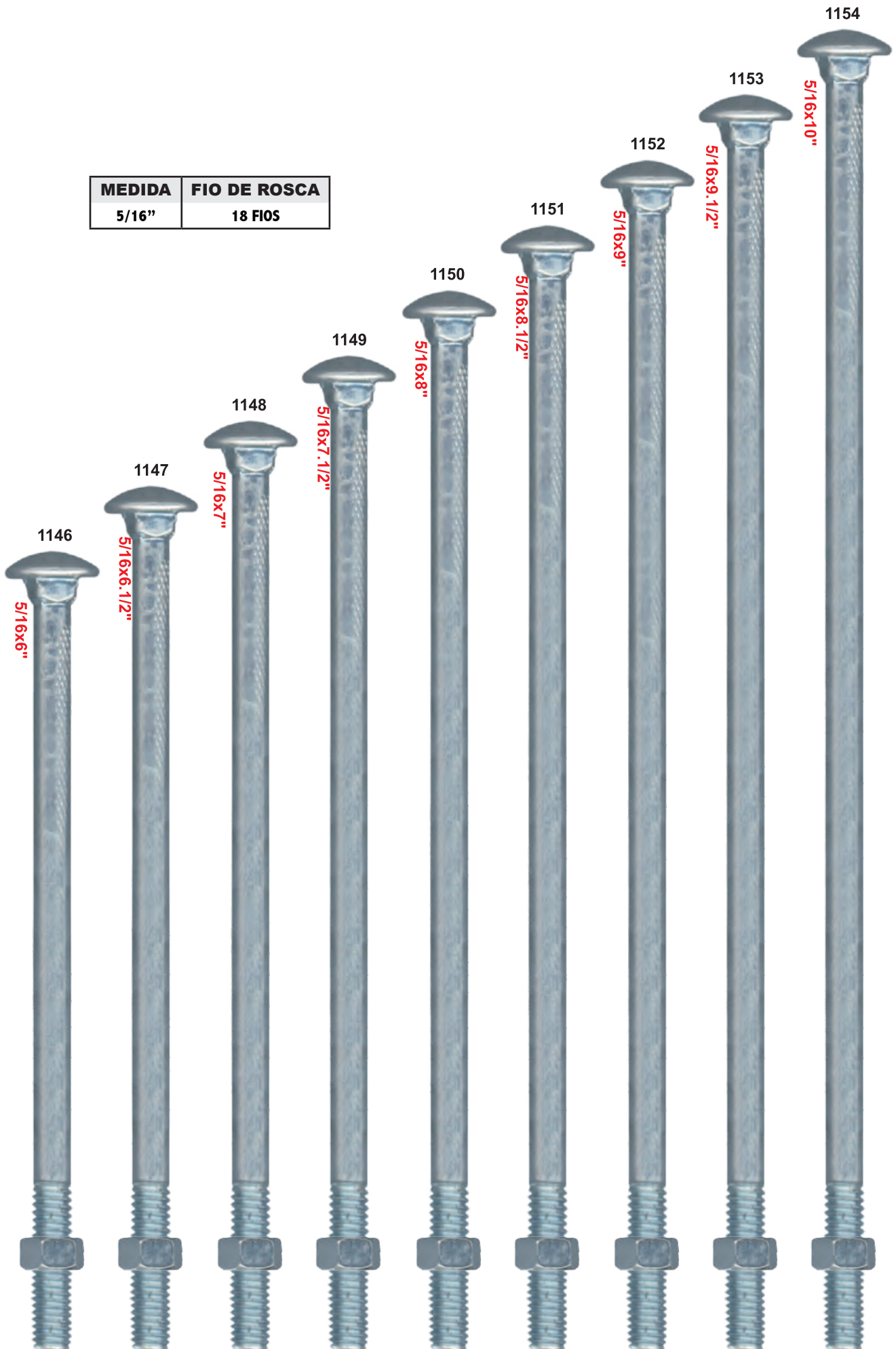

PARAFUSO FRANCES COM PORCA ROSCA GROSSA (UNC) ZINCADO 3/8"

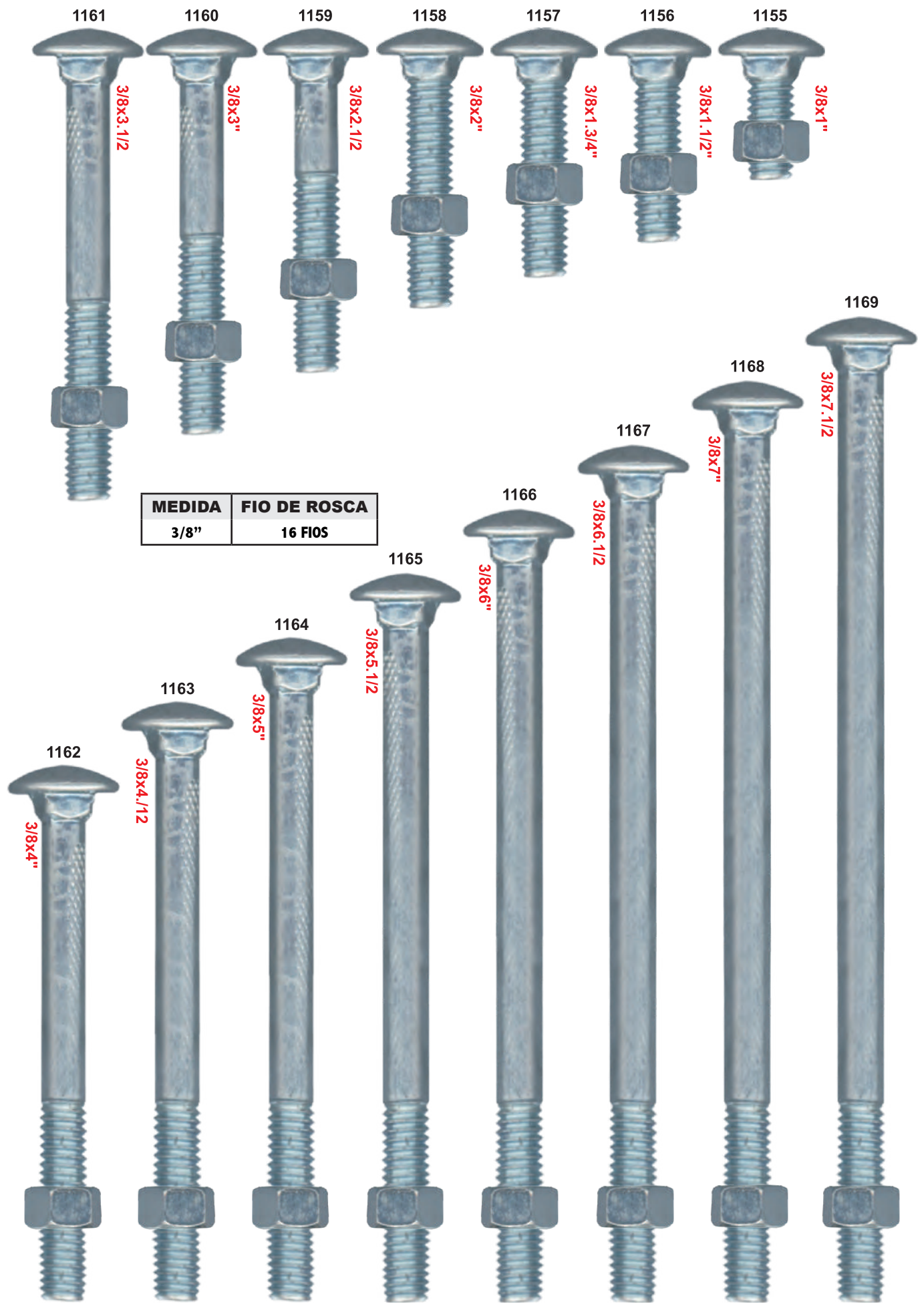
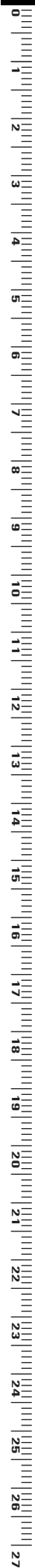

MEDIDA	FIO DE ROSCA
3/8"	16 FIOS

PARAFUSO FRANCES COM PORCA ROSCA GROSSA (UNC) ZINCADO 3/8"

MEDIDA	FIO DE ROSCA
3/8"	16 FIOS

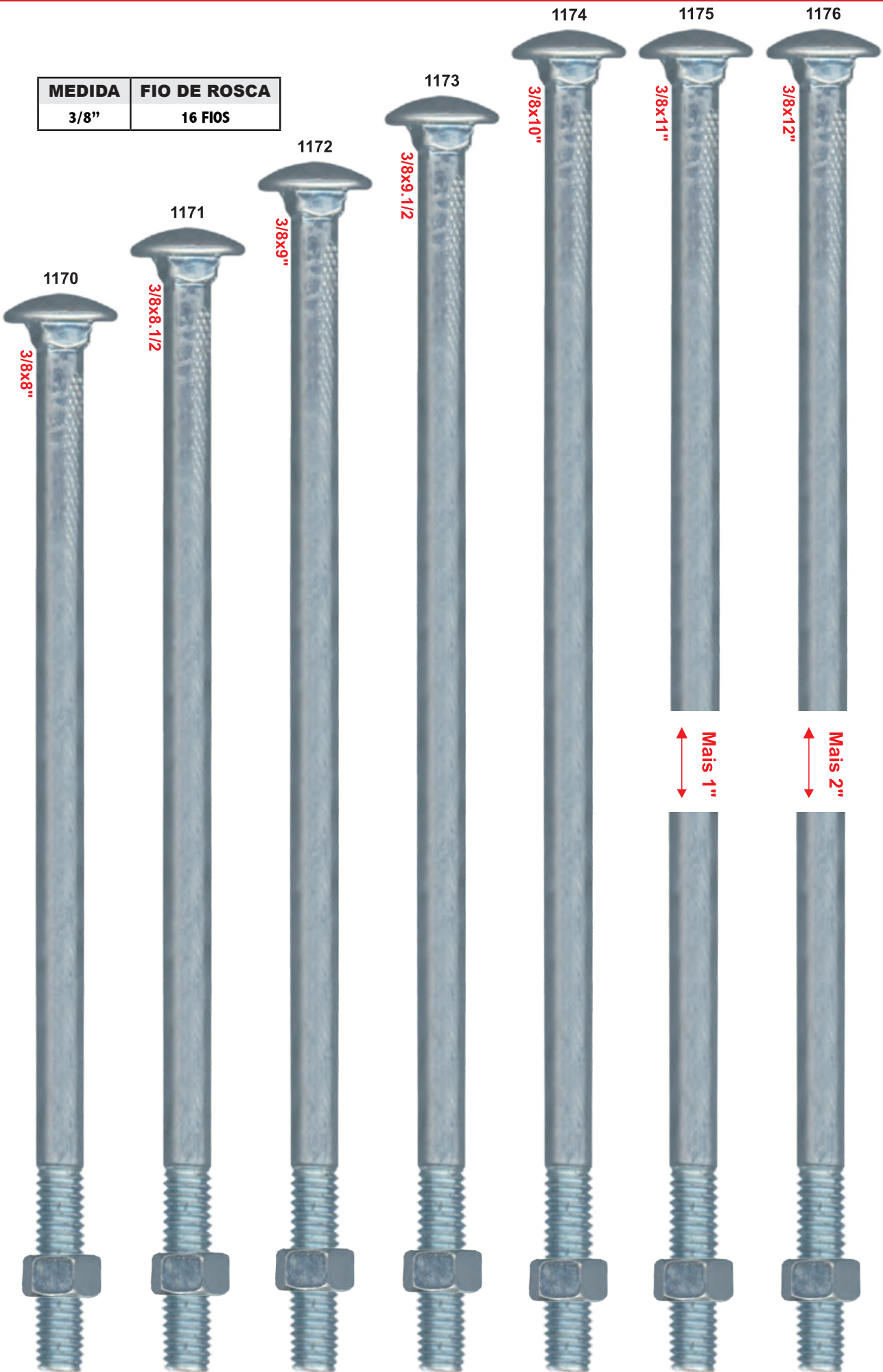

PARAFUSO FRANCES COM PORCA ROSCA GROSSA (BSW) ZINCADO 1/2"

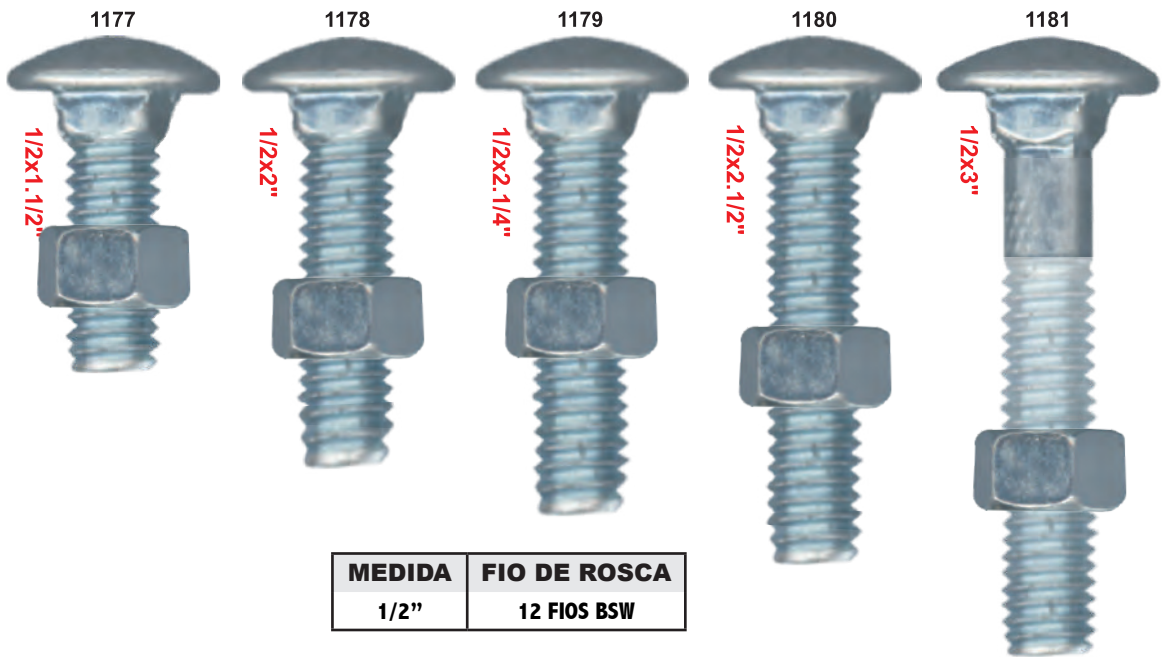

MEDIDA	FIO DE ROSCA
1/2"	12 FIOS BSW

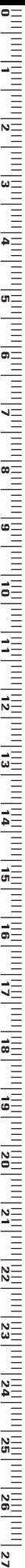
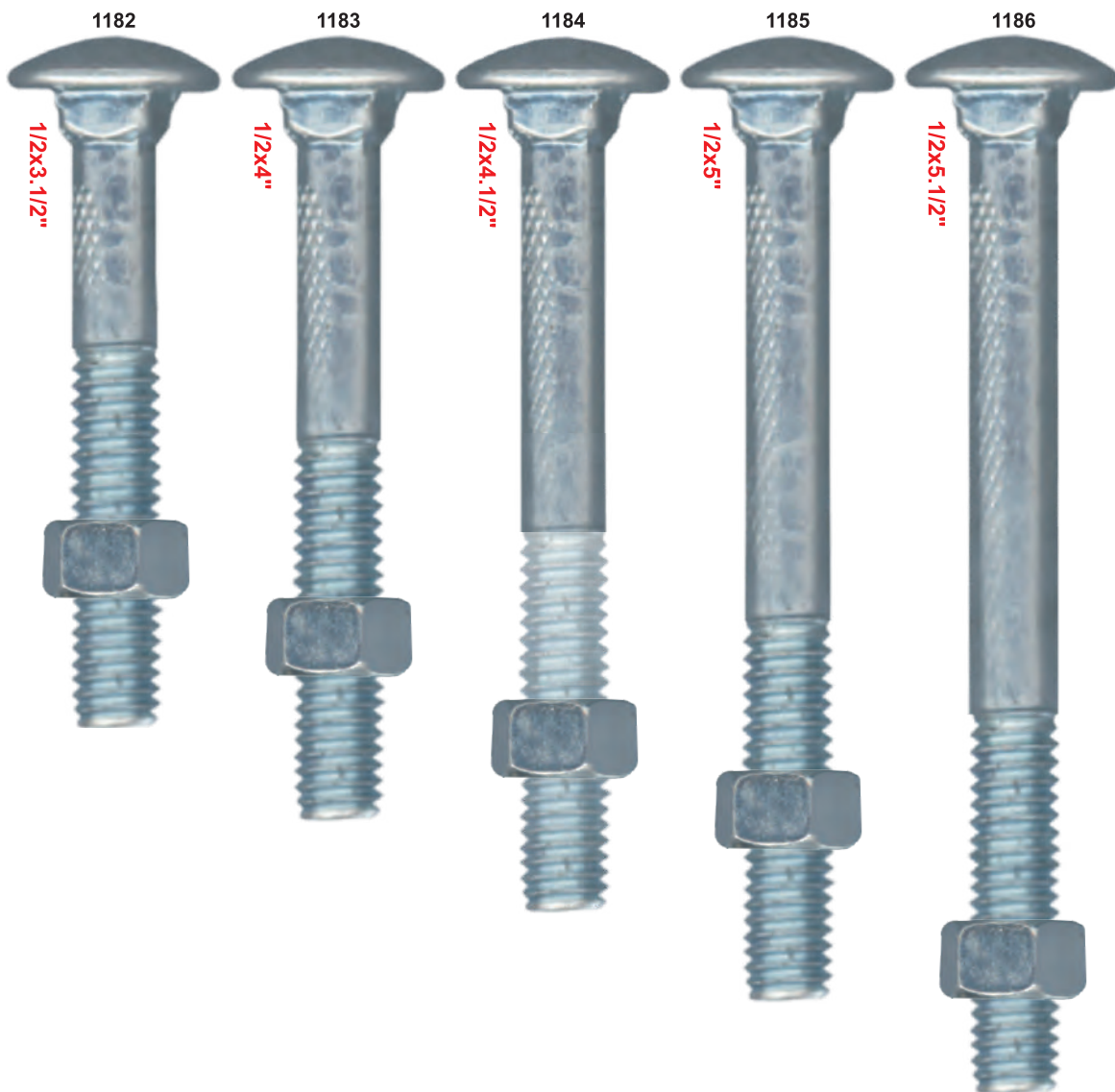

PARAFUSO FRANCES COM PORCA ROSCA GROSSA (BSW) ZINCADO 1/2"

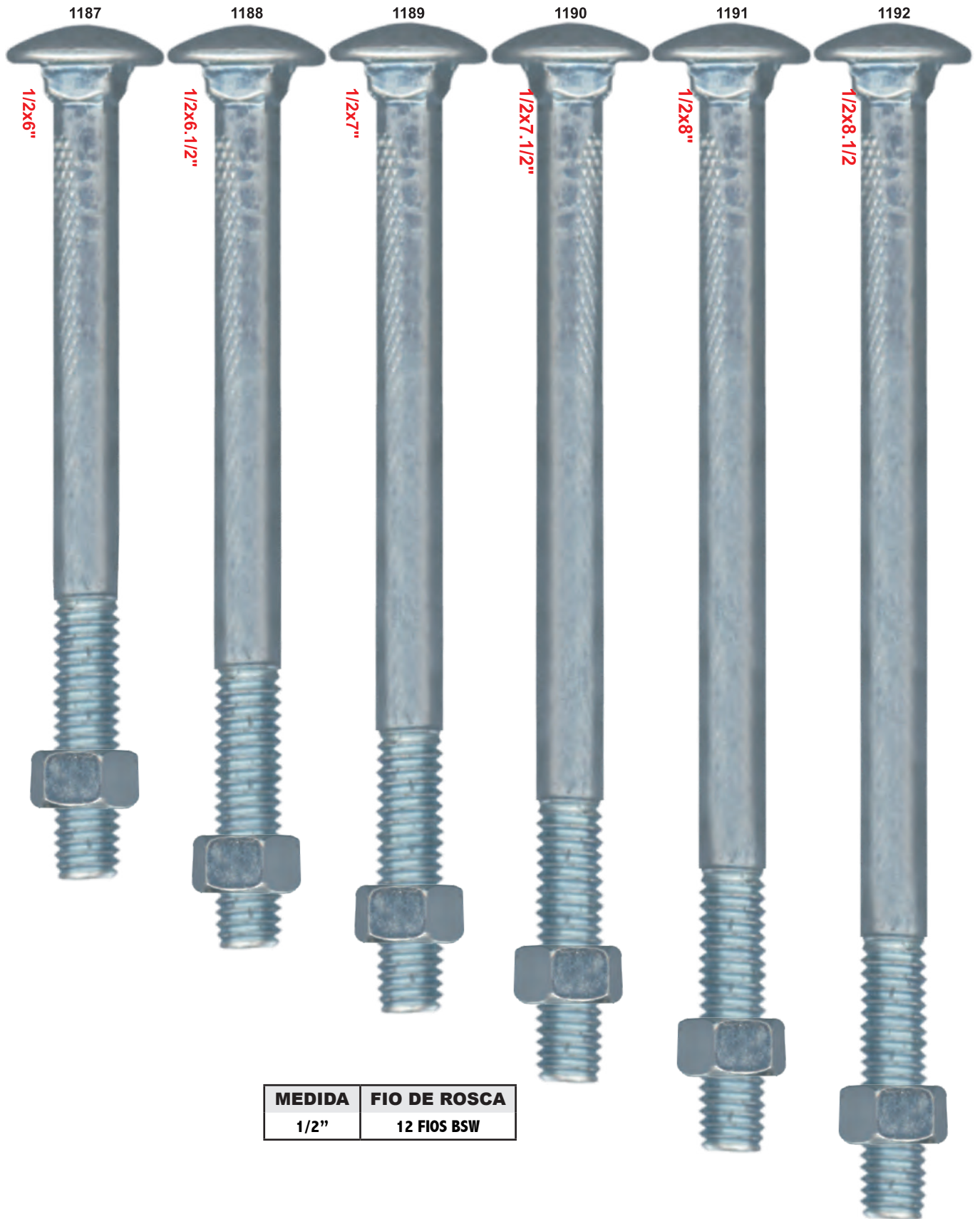

MEDIDA	FIO DE ROSCA
1/2"	12 FIOS BSW



PARAFUSO FRANCES COM PORCA ROSCA GROSSA (BSW) ZINCADO 1/2"

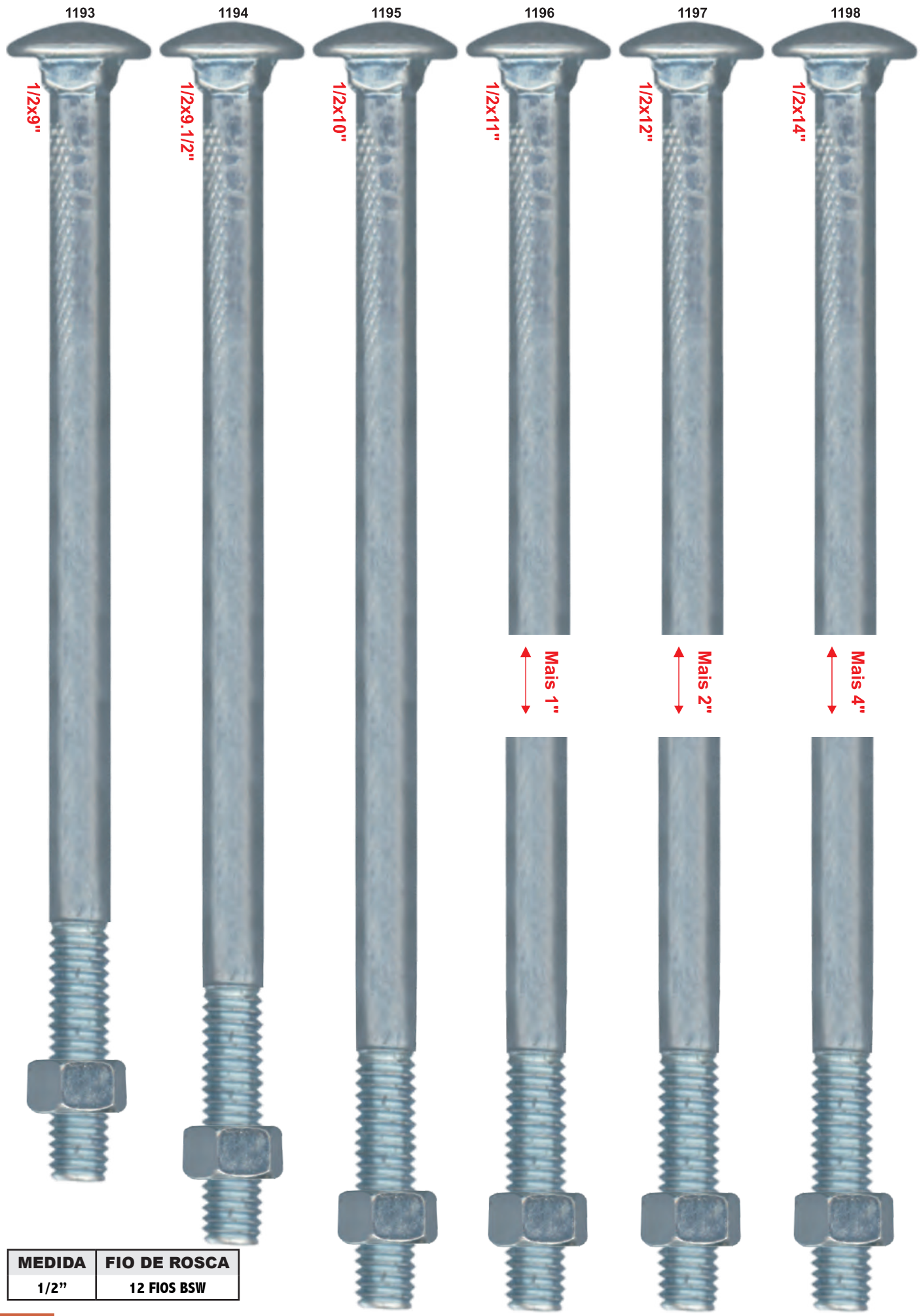

MEDIDA	FIO DE ROSCA
1/2"	12 FIOS BSW

PARAFUSO FRANCES SEM PORCA AÇO 8.8 ROSCA GROSSA (MA) BICROM. M-6

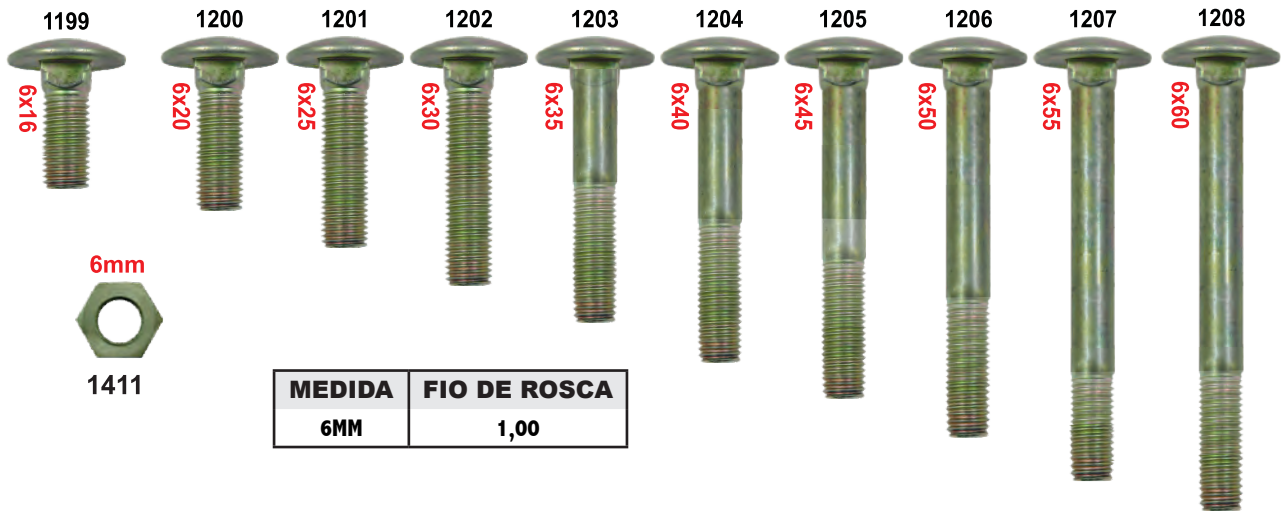

PARAFUSO FRANCES SEM PORCA AÇO 8.8 ROSCA GROSSA (MA) BICROM. M-8

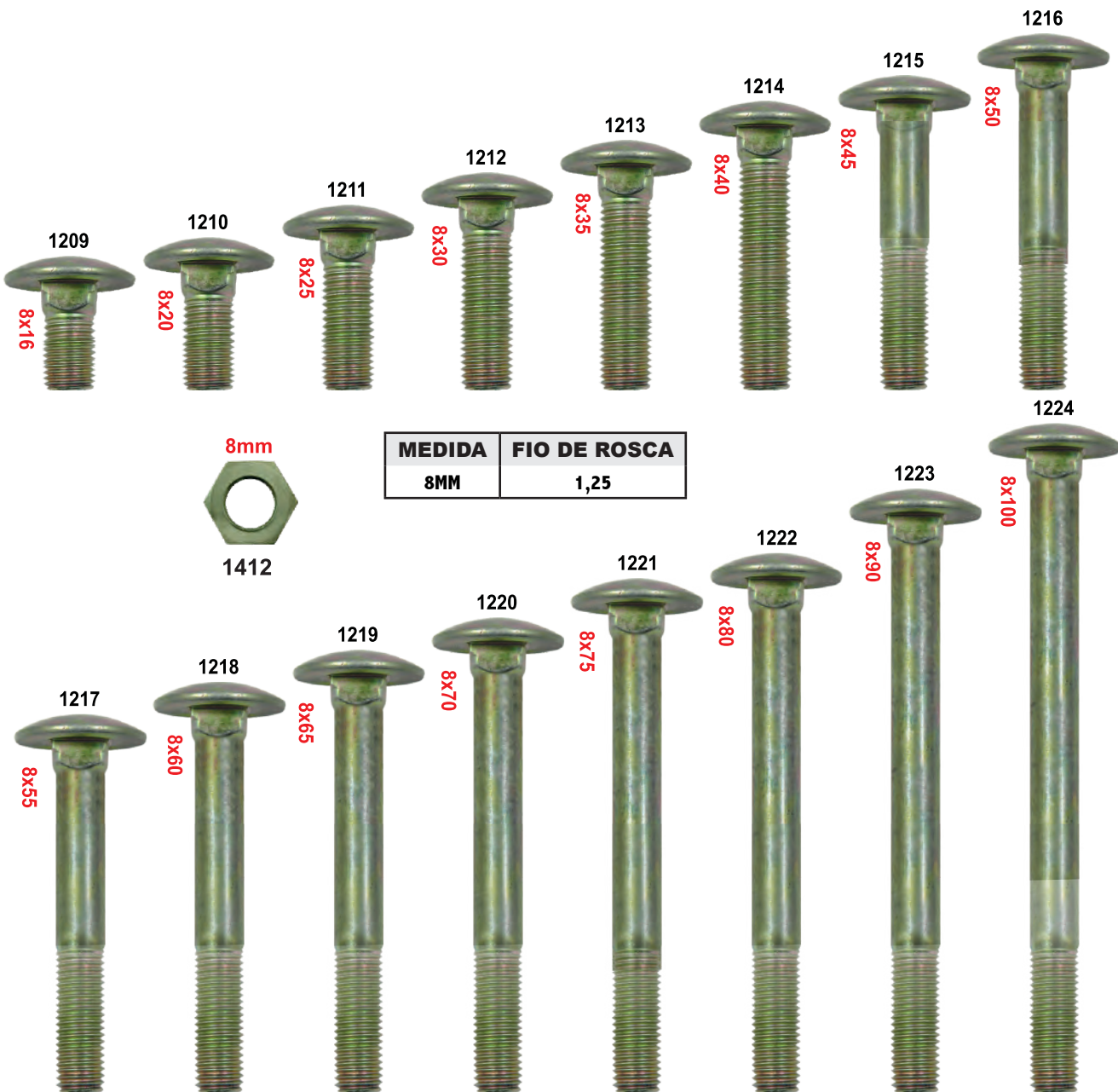

PARAFUSO FRANCES SEM PORCA AÇO 8.8 ROSCA GROSSA (MA) BICROM. M-10



MEDIDA	FIO DE ROSCA
10MM	1,50



1413

PARAFUSO FRANCES SEM PORCA AÇO 8.8 ROSCA GROSSA (MA) BICROM. M-12



MEDIDA	FIO DE ROSCA
12MM	1,75



PARAFUSO ALLEN CABEÇA CILINDRICA AÇO 12.9 ROSCA GROSSA (MA) M-4

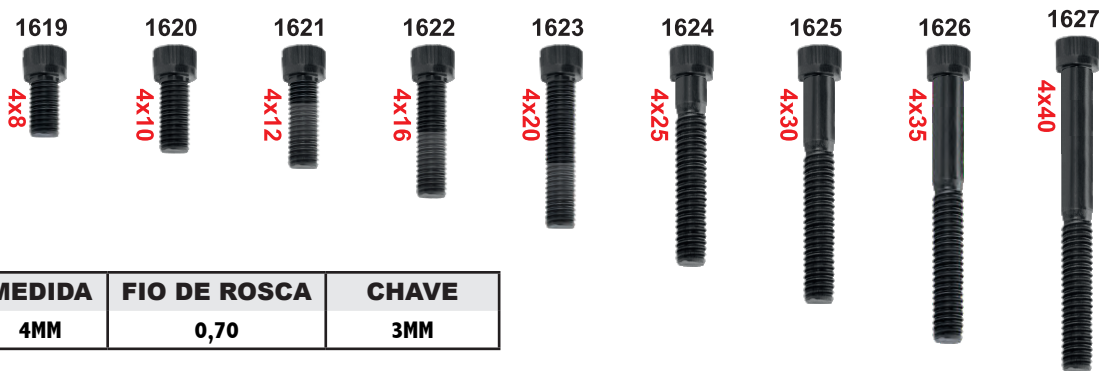

MEDIDA	FIO DE ROSCA	CHAVE
4MM	0,70	3MM

PARAFUSO ALLEN CABEÇA CILINDRICA AÇO 12.9 ROSCA GROSSA (MA) M-5

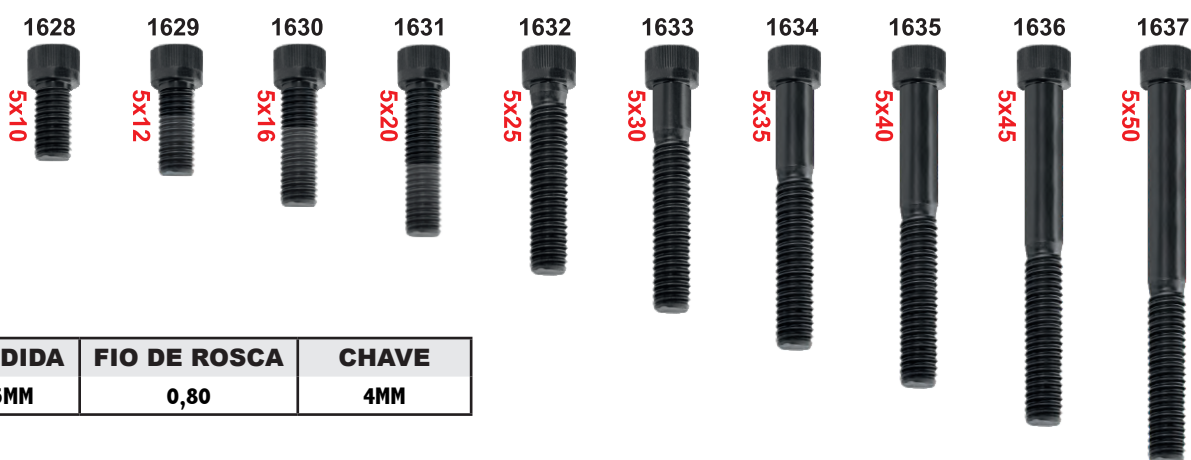

MEDIDA	FIO DE ROSCA	CHAVE
5MM	0,80	4MM

PARAFUSO ALLEN CABEÇA CILINDRICA AÇO 12.9 ROSCA GROSSA (MA) M-6

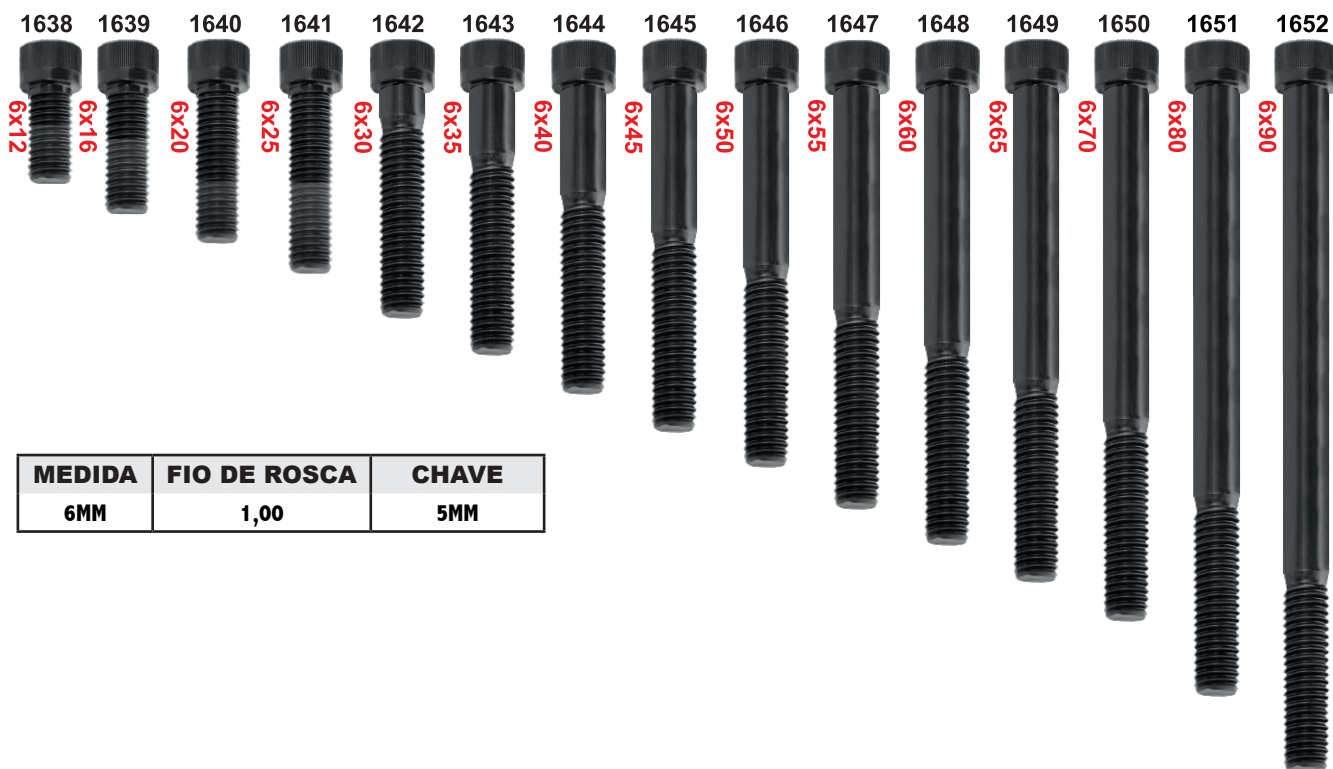

MEDIDA	FIO DE ROSCA	CHAVE
6MM	1,00	5MM

PARAFUSO ALLEN CABEÇA CILINDRICA AÇO 12.9 ROSCA GROSSA (MA) M-8



MEDIDA	FIO DE ROSCA	CHAVE
8MM	1,25	6MM



PARAFUSO ALLEN CABEÇA CILINDRICA AÇO 12.9 ROSCA GROSSA (MA) M-10



MEDIDA	FIO DE ROSCA	CHAVE
10MM	1,50	8MM

PARAFUSO ALLEN CABEÇA CILINDRICA AÇO 12.9 ROSCA GROSSA (MA) M-12

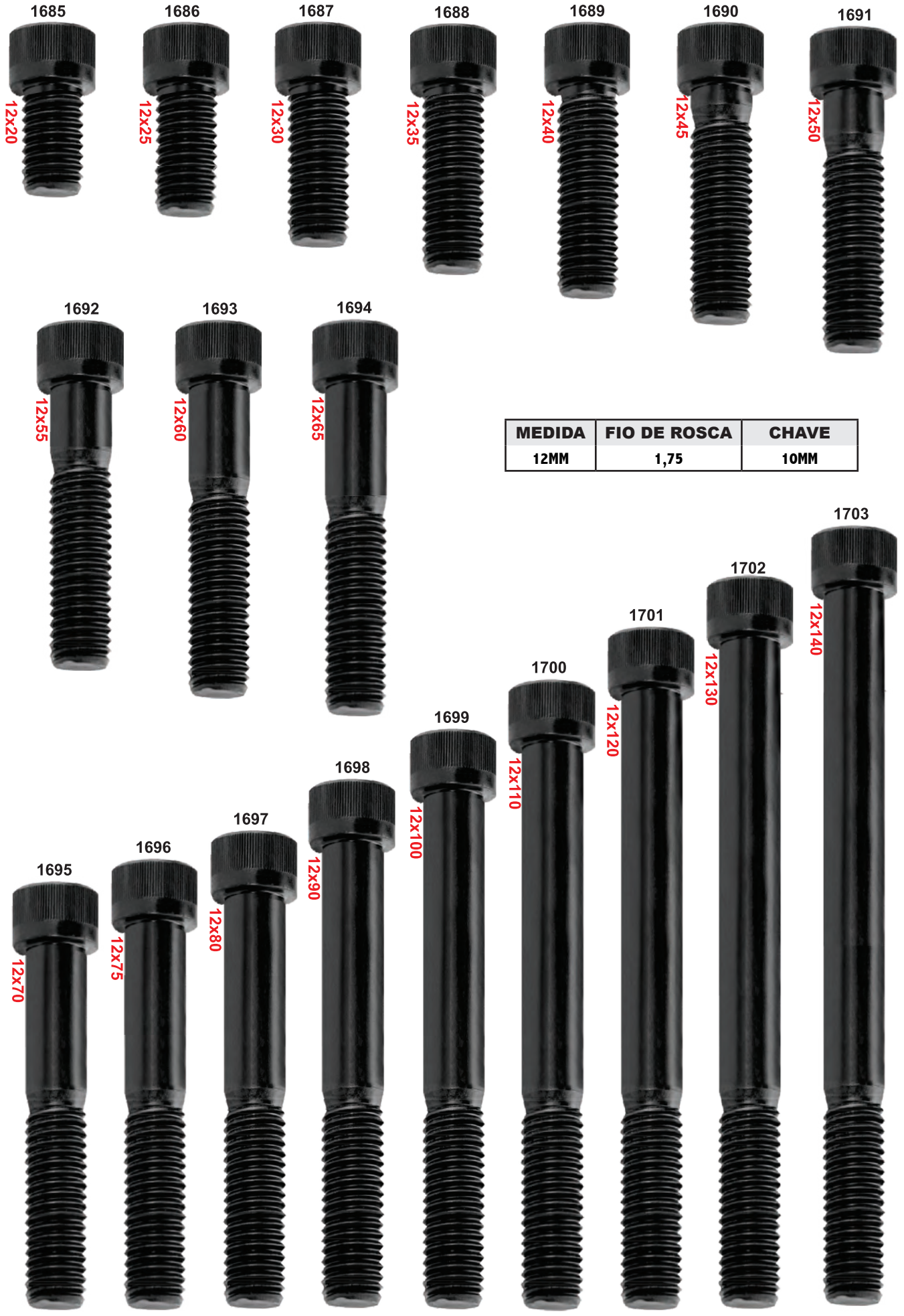

MEDIDA	FIO DE ROSCA	CHAVE
12MM	1,75	10MM





4759
PORCA RODA ZINCADA KOMBI 82/...
M-14X1,50 CH-19



4760
PORCA RODA ZINCADA D-10/ OPALA .../79
7/16X20UNF CH-19



4761
PORCA RODA ZINCADA D-20/ D-10/ CHEVETTE/
OPALA/ CARAVAN/ FIESTA/ KA/ COURIER/
FOCUS/ BANDEIRANTES M-12X1,50 CH-19



4762
PORCA RODA ZINCADA (FERRO) NOVA S-10
12/... M-12X1,50 CH-19



4763
PORCA RODA ZINCADA D-40 85/97 9/16X18UNF
CH-22



4764
PORCA RODA ZINCADA F-1000/ F-100 83/98
1/2X20UNF CH-21



4765
PORCA RODA ZINCADA F-250/ F-350 .../03
M-14X2,00 CH-21



4766
PORCA RODA ZINCADA F-250/ F-350 03/...
M-14X1,50 CH-21



4767
PORCA RODA ZINCADA ESQ.(L) F-4000 76/95
5/8X18UNF CH-27



4768
PORCA RODA ZINCADA DIR.(R) F-4000 76/95
5/8X18UNF CH-27



4769
PORCA RODA ZINCADA (ARRUELA OSCILANTE)
F-4000 96/... VOLKS 6.80/ 6.90/ 7.110/
8.140 M.BENZ 709/ 712C/ 812/ 912/ C914
VOLARE A5/ A6/ A8 M-18X1,50 CH-27



4770
PORCA RODA ZINCADA BANDEIRANTE
M-12X1,50 CH-23



4771
PORCA RODA ZINCADA HR 08/... M-14X1,50
CH-22





4772
PORCA RODA CROMADA D-10/ OPALA ATE 80 7/16X20UNF CH-19



4773
PORCA RODA PRETA D-20/ D-10/ S-10/ BLAZER/ CHEVETTE/ SILVERADO M-12X1,50 CH-19





4774
PORCA RODA CROMADA D-20/ D-10/ S-10/ BLAZER/ CHEVETTE/ SILVERADO/ FIESTA/ KA/ COURIER/ ECOSPORT/ KA/ FOCUS/ LOGUS/ POINTER M-12X1,50 CH-19



4775
PORCA RODA CROMADA NOVA S-10/TRAILBLAZER 12/16 ONIX/ PRISMA/ COBALT/ CRUZE 12/19 M-12X1,50 CH-19



4776
PORCA RODA CROMADA NOVA S-10/TRAILBLAZER 17/... ONIX/ PRISMA 20/... CRUZE TURBO 18/... M-12X1,50 CH-19



4777
PORCA RODA CROMADA (ARRUELA OSCILANTE) FIESTA/ KA/ ECOSPORT/ FOCUS 99/... M-12X1,50 CH-19



4778
PORCA RODA CROMADA F-1000/ F-100 83/98 1/2X20UNF CH-21



4779
PORCA RODA CROMADA F-1000 / F-1000 TURBO 98/... RANGER 4X4 97/99 1/2X20UNF CH-21



4780
PORCA RODA CROMADA (FECHADA) NOVA RANGER/ NOVO KA 13/... M-12X1,50 CH-19



4781
PORCA RODA CROMADA (VAZADA) NOVA RANGER/ NOVO KA 15/... NEW FIESTA 12/15 M-12X1,50 CH-19



4782
PORCA RODA CROMADA (FERRO) HB20 12/.. CRETA 17/... I30/ ELANTRA/ SONATA/ TUCKSON 01/... L-200 92/07 M-12X1,50 CH-21



4783
PORCA RODA CROMADA (LIGA) HB20 12/.. ELANTRA/ IX35/ TUCSON/ I30/ AZERA/ SANTA FE/ VELOSTER/ SONATA 06/... M-12X1,50 CH-21



4784
PORCA RODA CROMADA (CURTA) COROLLA/ FIELDER 03/08 ETIOS 12/... HILUX .../04 M-12X1,50 CH-21



4785
PORCA RODA PRETA (FERRO) HILUX 92/04 M-12X1,50 CH-21



4786
PORCA RODA CROMADA (FERRO) HILUX 92/04 M-12X1,50 CH-21



4787
PORCA RODA CROMADA (LONGA) HILUX/ SW4 05/... COROLLA/RAV4 08/... M-12X1,50 CH-21



4788
PORCA RODA CROMADA L-200 TRITON 07/... PAJERO/ ASX/ OUTLANDER M-12X1,50 CH-21



4789
PORCA RODA CROMADA (LIGA) FRONTIER/ MARCH/ VERSA/ KICKS/ SENTRA M-12X1,25 CH-21



4790
PORCA RODA CROMADA (FERRO) FRONTIER/ MARCH/ VERSA/ KICKS/ SENTRA/ SUZUKI M-12X1,25 CH-21



4792
PORCA RODA CROMADA (ARRUELA OSCILANTE) RAM 12/18 M-14X1,50 CH-21



4793
PORCA RODA CROMADA (FLANGE RAM 12/18 M-14X1,50 CH-22



4794
PORCA RODA CROMADA (BAIXA) CIVIC/CITY/FIT/CR-V/ACCORD M-12X1,50 CH-19 H30



4795
PORCA RODA CROMADA (ALTA) CIVIC/CITY/FIT/CR-V/ACCORD M-12X1,50 CH-19 H35

Roda

PARAFUSO RODA S/ PORCA



4796
PARAFUSO RODA DIANT. KOMBI 82/... M-14X1,50X45 / 50,5



4797
PARAFUSO RODA TRAS. KOMBI 82/... M-14X1,50X35 / 40,5



4798
PARAFUSO RODA DIANT./TRAS. D-10/ C-10/ A-10 .../79 7/16X20UNFX32,5 / 39



4799
PARAFUSO RODA DIANT./TRAS. D-10/ C-10/ A-10 .../79 7/16X20UNFX38,1 / 44,5 – LONGO



4800
PARAFUSO RODA DIANT. D-20 85/96 S-10 95/11 DIANT./TRAS. D-10/ OPALA/ CARAVAN/ CHEVETTE 80/... M-12X1,50X37 / 41



4801
PARAFUSO RODA TRAS. D-20 85/92 S-10/ BLAZER 95/11 M-12X1,50X42 / 46,5



4802
PARAFUSO RODA TRAS. D-20 93/96 SILVERADO 97/01 M-12X1,50X46 / 52



4803
PARAFUSO RODA DIANT. NOVA S-10 12/... M-12X1,50X37 / 41



4804
PARAFUSO RODA TRAS. NOVA S-10 12/... DIANT./TRAS. ONIX/ PRISMA/ COBALT/ CRUZE/ SONIC/ CAPTIVA/ TRACKER 12/... M-12X1,50X52 / 56,5



4805
PARAFUSO RODA DIANT. D-40 85/97 9/16X18UNFX55,2 / 61,1



4806
PARAFUSO RODA TRAS. D-40 85/97 9/16X18UNFX81 / 88,9



4807
PARAFUSO RODA DIANT. FIESTA/ KA/ COURIER/ FOCUS/ ECOSPORT/ ESCORT/ VERONA/ LOGUS/ POINTER M-12X1,50X40,5 / 45



4808
PARAFUSO RODA TRAS. FIESTA/ KA/ COURIER/ FOCUS/ ECOSPORT/ ESCORT/ VERONA/ LOGUS/ POINTER M-12X1,50X36,5 / 41



4809
PARAFUSO RODA DIANT./TRAS F-1000/ F-100 80/92 1/2X20UNFX44,5 / 49



4810
PARAFUSO RODA DIANT./TRAS F-1000 93/98 1/2X20UNFX54 / 58,5



4811
PARAFUSO RODA DIANT./TRAS. RANGER 00/12 1/2X20UNFX57,15 / 61,65



4812
PARAFUSO RODA NOVA RANGER 13/... M-12X1,50X46 / 51



4813
PARAFUSO RODA DIANT. ESQ. (L) F-4000 76/95 5/8X18UNFX53 / 60



4814
PARAFUSO RODA DIANT. DIR. (R) F-4000 76/95 5/8X18UNFX53 / 60



4815
PARAFUSO RODA TRAS. ESQ. (L) F-4000 76/95 5/8X18UNFX61 / 68



4816
PARAFUSO RODA TRAS. DIR. (R) F-4000 76/95 5/8X18UNFX61 / 68



4817
PARAFUSO RODA DIANT. ESQ. (L) F-4000 90/... FREIO A DISCO 5/8X18UNFX66 / 75



4818
PARAFUSO RODA DIANT. DIR (R) F-4000 90/... FREIO A DISCO 5/8X18UNFX66 / 75



4819
PARAFUSO RODA DIANT. F-4000 96/... FREIO A DISCO M-18X1,50X72 / 81



4820
PARAFUSO RODA TRAS. F-4000 96/... FREIO A DISCO M-18X1,50X81 / 92



4821
PARAFUSO RODA TRAS. F-4000 98/... FREIO A TAMBOR M-18X1,50X72 / 81



4822
PARAFUSO RODA TRAS. F-4000 99/... FORD CARGO 814/ 815 VOLKS 7.100/ 8.100/ 8.140/ ONIBUS M-18X1,50X90 / 99



4823
PARAFUSO RODA DIANT./TRAS. F-250/ F-350 98/03 M-14X2,00X66 / 71



4824
PARAFUSO RODA DIANT./TRAS. F-250/ F-350 03/... M-14X1,50X70 / 75



4825
PARAFUSO RODA DIANT./TRAS. BANDEIRANTE/ TROLLER M-12X150X45,5 / 51



4826
PARAFUSO RODA DIANT. HILUX 92/04 M-12X1,50X52,5 / 57,5











4827
PARAFUSO RODA DIANT. HILUX/ SW4 05/... COROLLA/ FIELDER 02/... M-12X1,50X40 / 45

  4828 PARAFUSO RODA TRAS. COROLLA/ FIELDER 02/... M-12X1,50X36 / 41	  4829 PARAFUSO RODA TRAS. HILUX/ SW4 92/... M-12X1,50X44,5 / 49,5	  4830 PARAFUSO RODA DIANT. L-200 GL/ GLS/ HPE/ SPORT/ TRITON 92/... M-12X1,50X43 / 48	  4831 PARAFUSO RODA TRAS. L-200 GL/ GLS/ HPE/ SPORT/ TRITON 92/... M-12X1,50X36 / 41
  4832 PARAFUSO RODA DIANT. FRONTIER/ SENTRA 98/07 M-12X1,25X39 / 44	  4833 PARAFUSO RODA TRAS. FRONTIER/ SENTRA 98/07 M-12X1,25X32 / 37	  4834 PARAFUSO RODA DIANT. FRONTIER 08/... M-12X1,25X46 / 50,5	  4835 PARAFUSO RODA TRAS. FRONTIER 08/... M-12X1,25X42 / 46,5
  4836 PARAFUSO RODA DIANT./TRAS. CIVIC/ FIT/ CITY/ ACCORD/CR-V 02/... HR-V 15/... M-12X1,50X38 / 43	  4837 PARAFUSO RODA DIANT./TRAS. HB20 12/... ELANTRA/ IX35/ TUCSON/ I30/ AZERA/ SANTA FE/ VELOSTER/ SONATA 06/... CERATO 10/19 M-12X1,50X45 / 49	  4838 PARAFUSO RODA DIANT. HR 08/... M-14X1,50X42 / 47	  4839 PARAFUSO RODA TRAS. HR 08/... M-14X1,50X48 / 53

Roda

KIT PARAFUSO DE RODA C/ PORCA

  4840 JOGO PARAF. RODA DIANT. KOMBI 82/... M-14X1,50X45 CH-19	  4841 JOGO PARAF. RODA TRAS. KOMBI 82/... M-14X1,50X35 CH-19	  4842 JOGO PARAF. RODA DIANT./TRAS. D-10/ C-10/ A-10 ATE 79 7/16X20UNFX32,5 CH-19 - CURTO	  4843 JOGO PARAF. RODA DIANT./TRAS. D-10/ C-10/ A-10 ATE 79 7/16X20UNFX38,1 CH-19 - LONGO
--	---	---	--





4844
 JOGO PARAF. RODA DIANT. D-20 85/96 S-10 95/11 DIANT./TRAS. D-10/ OPALA/ CARAVAN/ CHEVETTE 80/... M-12X1,50X37 CH-19



4845
 JOGO PARAF. RODA TRAS. D-20 85/92 S-10/ BLAZER 95/11 M-12X1,50X42 CH-19



4846
 JOGO PARAF. RODA DIANT. (PRETA) D-20 85/96 S-10 95/11 DIANT./TRAS. D-10/ OPALA/ CARAVAN/ CHEVETTE 80/... M-12X1,50X37 CH-19



4847
 JOGO PARAF. RODA TRAS. (PRETA) D-20 85/92 S-10/ BLAZER 95/11 M-12X1,50X42 CH-19



4848
 JOGO PARAF. RODA DIANT. (CROMADA) D-20 85/96 S-10 95/11 DIANT./TRAS. D-10/ OPALA/ CARAVAN/ CHEVETTE 80/... M-12X1,50X37 CH-19





4849
 JOGO PARAF. RODA TRAS. (CROMADA) D-20 85/92 S-10/ BLAZER 95/11 M-12X1,50X42 CH-19





4850
 JOGO PARAF. RODA TRAS. (PRETA) D-20 93/96 SILVERADO 97/01 M-12X1,50X46 CH-19





4851
 JOGO PARAF. RODA TRAS. (CROMADA) D-20 93/96 SILVERADO 97/01 M-12X1,50X46 CH-19

4852
 JOGO PARAF. RODA DIANT. NOVA S-10 12/... M-12X1,50X37 CH-19



4853
 JOGO PARAF. RODA TRAS. NOVA S-10 12/... DIANT./TRAS. ONIX/ PRISMA/ COBALT/ CRUZE/ SONIC/ CAPTIVA/ TRACKER 12/... M-12X1,50X52 CH-19

4854
 JOGO PARAF. RODA DIANT. D-40 85/97 9/16X18UNFX55,2 CH-22



4855
 JOGO PARAF. RODA TRAS. D-40 85/97 9/16X18UNFX81 CH-22



4856
 JOGO PARAF. RODA DIANT. FIESTA/ KA/ COURIER/ FOCUS/ ECOSPORT/ ESCORT/ VERONA/ LOGUS/ POINTER M-12X1,50X40,5 / 45





4857
 JOGO PARAF. RODA TRAS. FIESTA/ KA/ COURIER/ FOCUS/ ECOSPORT/ ESCORT/ VERONA/ LOGUS/ POINTER M-12X1,50X36,5 / 41



4858
 JOGO PARAF. RODA DIANT. FIESTA/ KA/ COURIER/ FOCUS/ ECOSPORT C/ ARRUELA OSCILANTE M-12X1,50X40,5 / 45



4859
 JOGO PARAF. RODA TRAS. FIESTA/ KA/ COURIER/ FOCUS/ ECOSPORT C/ ARRUELA OSCILANTE M-12X1,50X36,5 / 41





4860
 JOGO PARAF. RODA DIANT./TRAS. F-1000/ F-100 80/92 1/2X20UNFX44,5 CH-21













































4861
 JOGO PARAF. RODA DIANT./TRAS. (CROMADA) F-1000 80/92 1/2X20UNFX44,5 CH-21



4862
 JOGO PARAF. RODA DIANT./TRAS. (CROMADA) F-1000 93/98 1/2X20UNFX54 CH-21





4863
 JOGO PARAF. RODA DIANT./TRAS. (CROMADA) RANGER 00/12 1/2X20UNFX57,15 CH-21

  <p>4864 JOGO PARAF. RODA DIANT./TRAS. (FECHADA) NOVA RANGER 13/... M-12X1,50X46 CH-19</p>	  <p>4865 JOGO PARAF. RODA DIANT. ESQ. (L) F-4000 76/95 5/8X18UNFX53 CH-27</p>	  <p>4866 JOGO PARAF. RODA DIANT. DIR. (R) F-4000 76/95 5/8X18UNFX53 CH-27</p>	  <p>4867 JOGO PARAF. RODA TRAS. ESQ. (L) F-4000 76/95 5/8X18UNFX61 CH-27</p>
  <p>4868 JOGO PARAF. RODA TRAS. DIR. (R) F-4000 76/95 5/8X18UNFX61 CH-27</p>	  <p>4869 JOGO PARAF. RODA DIANT. ESQ. (L) F-4000 90/... FREIO A DISCO 5/8X18UNFX66 CH-27</p>	  <p>4870 JOGO PARAF. RODA DIANT. DIR. (R) F-4000 90/... FREIO A DISCO 5/8X18UNFX66 CH-27</p>	  <p>4871 JOGO PARAF. RODA DIANT. F-4000 96/... FREIO A DISCO M-18X1,50X72 CH-27</p>
  <p>4872 JOGO PARAF. RODA TRAS. F-4000 96/... FREIO A DISCO M-18X1,50X81 CH-27</p>	  <p>4873 JOGO PARAF. RODA DIANT. F-4000 98/... M-18X1,50X60 CH-27</p>	  <p>4874 JOGO PARAF. RODA TRAS. F-4000 98/... FREIO A TAMBOR M-18X1,50X72 CH-27</p>	   <p>4875 JOGO PARAF. RODA TRAS. F-4000 99/... FORD CARGO 814/ 815 VOLKS 7.100/ 8.100/ 8.140/ ONIBUS M-18X1,50X90 CH-27</p>
  <p>4876 JOGO PARAF. RODA DIANT./TRAS. F-250/ F-350 98/03 M-14X2,00X66 CH-21</p>	  <p>4877 JOGO PARAF. RODA DIANT./TRAS. F-250/ F-350 03/... M-14X1,50X70 CH-21</p>	  <p>4878 JOGO PARAF. RODA DIANT./TRAS. BANDEIRANTE M-12X150X45,5 CH-23</p>	  <p>4879 JOGO PARAF. RODA DIANT. (CURTA) CO-ROLLA/ FIELDER 02/07 HILUX/ SW4 92/04 M-12X1,50X40 CH-21</p>
  <p>4880 JOGO PARAF. RODA TRAS. (CURTA) CO-ROLLA/ FIELDER 02/07 HILUX/ SW4 92/04 M-12X1,50X36 CH-21</p>	  <p>4881 JOGO PARAF. RODA DIANT. (PRETA) HILUX 92/04 RODA FERRO M-12X1,50X52,5 CH-21</p>	  <p>4882 JOGO PARAF. RODA TRAS. (PRETA) HILUX 92/04 RODA FERRO M-12X1,50X44,5 CH-21</p>	  <p>4883 JOGO PARAF. RODA DIANT. (CROMADA) HILUX/ SW4 05/... HILUX 92/04 RODA FERRO M-12X1,50X40 CH-21</p>





4884
JOGO PARAF. RODA TRAS. (CROMADA) HILUX/
SW4 05/... HILUX 92/04 RODA FERRO
M-12X1,50X44,5 CH-21



4885
JOGO PARAF. RODA DIANT.(LONGA) HILUX/
SW4 05/... COROLLA/ FIELDER 08/... RAV4
M-12X1,50X40 CH-21





4886
JOGO PARAF. RODA TRAS. (LONGA) HILUX/
SW4 05/... COROLLA/ FIELDER 08/... RAV4
M-12X1,50X44,5 CH-21

4887
JOGO PARAF. RODA DIANT. L-200 GL/ GLS/ HPE
92/06 M-12X1,50X43 CH-21



4888
JOGO PARAF. RODA TRAS. L-200 GL/ GLS/ HPE
92/06 M-12X1,50X36 CH-21

4889
JOGO PARAF. RODA DIANT. L-200 TRITON 07/...
M-12X1,50X43 CH-21



4890
JOGO PARAF. RODA TRAS. L-200 TRITON 07/...
M-12X1,50X36 CH-21



4891
JOGO PARAF. RODA DIANT. FRONTIER/ SENTRA
98/07 M-12X1,25X39 CH-21



4892
JOGO PARAF. RODA TRAS. FRONTIER/ SENTRA
98/07 M-12X1,25X32 CH-21



4893
JOGO PARAF. RODA DIANT. FRONTIER 08/...
M-12X1,25X46 CH-21





4894
JOGO PARAF. RODA TRAS. FRONTIER 08/...
M-12X1,25X42 CH-21



4895
JOGO PARAF. RODA DIANT./TRAS. CIVIC/ FIT/
CITY/ ACCORD/CR-V 02/... HR-V 15/... C/
PORCA ALTA M-12X1,50X38 CH-19 H35



4896
JOGO PARAF. RODA DIANT./TRAS. CIVIC/ FIT/
CITY/ ACCORD/CR-V 02/... HR-V 15/... C/
PORCA BAIXA M-12X1,50X38 CH-19 H30



4897
JOGO PARAF. RODA DIANT./TRAS. HB20 12/..
ELANTRA/ IX35/ TUCSON/ I30/ AZERA/ SANTA
FE/ VELOSTER/ SONATA 06/... RODA LIGA
M-12X1,50X45 CH-21



4898
JOGO PARAF. RODA DIANT./TRAS. HB20 12/..
TUCSON 06/... RODA FERRO M-12X1,50X45
CH-21



4899
JOGO PARAF. RODA DIANT. HR 04/...
M-12X1,50X42 CH-22

4900
JOGO PARAF. RODA TRAS. HR 04/...
M-12X1,50X48 CH-22



4901
JOGO PRISIONEIRO CUBO RODA 8X8X42 BANDEIRANTES/ HILUX



4902
JOGO PRISIONEIRO CUBO RODA 12X1,50 – 12X1,75 X 57 MERCEDES 1111/ 1113/ 1513/ 2013





4903
JOGO PRISIONEIRO CUBO RODA 1/2X13UNC – 1/2X20UNF X 2.1/2 GM D-12000/ D-60 FORD F-11000 A F-22000





4904
JOGO PRISIONEIRO CUBO RODA 7/16X14UNC – 7/16X20UNF X 2 GM D-60/ C-60/ F-4000/ F-350





4905
JOGO PRISIONEIRO CUBO RODA 7/16X14UNC – 7/16X20UNF X 2.1/2 GM D-60/ C-60 FORD F-4000/ F-350/ F-2000



4906
JOGO PRISIONEIRO CUBO RODA 9/16X12UNC – 9/16X18UNF X 2.1/2 GM/ DODGE/ DIVERSOS





4907
JOGO PRISIONEIRO CUBO RODA 5/8X11UNC – 5/8X18UNF X 2.1/2 GM D-70/ D-13000 FORD F-11000 A F-22000





4908
JOGO PRISIONEIRO CUBO RODA 5/8X11UNC – 5/8X18UNF X 3 GM D-70/ D-13000 FORD F-11000 A F-22000



4909
JOGO PRISIONEIRO CUBO RODA 20X2,00X80 SCANIA R112/ R112H/ R142/ T112/ T112H/ T113/ GUERRA



4910
PRISIONEIRO CUBO RODA 8X8X42 BANDEIRANTES/ HILUX







4911
PRISIONEIRO CUBO RODA 12X1,50 – 12X1,75 X 57 MERCEDES 1111/ 1113/ 1513/ 2013







4912
PRISIONEIRO CUBO RODA 1/2 X 13UNC – 1/2 X 20UNF X 2.1/2 GM D-12000/ D-60 FORD F-11000 A F-22000

4913
PRISIONEIRO CUBO RODA 7/16 X 14UNC – 7/16 X 20UNF X 2 GM D-60/ C-60 FORD F-4000/ F-350

4914
PRISIONEIRO CUBO RODA 7/16 X 14UNC – 7/16 X 20UNF X 2.1/2 GM D-60/ C-60 FORD F-4000/ F-350/ F-2000



4915
PRISIONEIRO CUBO RODA 9/16 X 12UNC – 9/16 X 18UNF X 2.1/2 GM/ DODGE/ DIVERSOS





4916
PRISIONEIRO CUBO RODA 5/8X11UNC – 5/8X18UNF X 2.1/2 GM D-70/ D-13000 FORD F-11000 A F-22000





4917
PRISIONEIRO CUBO RODA 5/8X11UNC – 5/8X18UNF X 3 GM D-70/ D-13000 FORD F-11000 A F-22000







4918
PRISIONEIRO CUBO RODA 20X2,00X80 SCANIA R112/ R112H/ R142/ T112/ T112H/ T113/ GUERRA

  8228 PORCA P/ PRISIONEIRO CUBO RODA M-8X1,25 BANDEIRANTES/ HILUX	  4920 PORCA P/ PRISIONEIRO CUBO RODA M-12X1,50 MERCEDES 1111/ 1113/ 1513/ 2013	  1570 PORCA P/ PRISIONEIRO CUBO RODA 1/2X20UNF GM/ FORD	  1569 PORCA P/ PRISIONEIRO CUBO RODA 7/16X20UNF GM/ FORD
  1571 PORCA P/ PRISIONEIRO CUBO RODA 9/16X18UNF GM/ DODGE	  1572 PORCA P/ PRISIONEIRO CUBO RODA 5/8X18UNF GM/ FORD	  4972 PORCA P/ PRISIONEIRO CUBO RODA SCANIA T1 12/T1 13/VOLVO N10/NL10/N12/NL12/ CARRETAS DIVERSAS (M-20X2,00 CH 27 H21) C/ FLANGE	 4926 ARRUELA CÔNICA FIXAÇÃO CALOTA RODA UNIVERSAL

PARAFUSO RODA

Roda

  4927 PARAFUSO RODA ZINCADO ESFÉRICO DIANT./TRAS. FUSCA/ BRASILIA/ KOMBI M-14X1,50X18,5 CH-19	  4928 PARAFUSO RODA ZINCADO ESFÉRICO DIANT./TRAS. GOL/ VOYAGE/ PASSAT 82/94 M-12X1,50X20,5 CH-17	  4929 PARAFUSO RODA ZINCADO ESFÉRICO DIANT./ TRAS. GOL/ PARATI/ SAVEIRO/ VOYAGE/ SANTA-NA 95/... CIELO 10/12 M-12X1,50X24 CH-17	  4930 PARAFUSO RODA ZINCADO ESFÉRICO DIANT./ TRAS. GOL GT/ SANTANA M-12X1,50X28 CH-17
  4931 PARAFUSO RODA ZINCADO ESFÉRICO DIANT./ TRAS. FOX/ GOLF/ POLO/ SPACEFOX/ T-CROSS/ TIGUAN/ BORA 03/... M-14X1,50X27 CH-17	  4932 PARAFUSO RODA ZINCADO ESFÉRICO DIANT./ TRAS. AMAROK 2.0 16V 10/... M-14X1,50X60 CH-17	  4933 PARAFUSO RODA ZINCADO CÔNICO DIANT./ TRAS. UNO/ 147/ ELBA/ PREMIO/ PALIO/ SIENA/ STRADA/ FIORINO/ IDEA M-12X1,25X22 CH-19	  4934 PARAFUSO RODA ZINCADO CÔNICO DIANT./TRAS. UNO/ PALIO/ SIENA/ STRADA/ PUNTO/ BRAVA/ MAREA/ IDEA M-12X1,25X26,5 CH-19

4935
PARAFUSO RODA ZINCADO CÔNICO ARGO/
CRONOS/ MOBI/ NOVA FIORINO/ GRAND SIENA/
PULSE/ STILO M-12X1,25X22 CH-19

4936
PARAFUSO RODA ZINCADO CÔNICO DIANT./
TRAS. DUCATO/ JUMPER/ BOXER 2.5 ARO 15
M-14X1,50X29 CH-24

4937
PARAFUSO RODA ZINCADO CÔNICO DIANT./TRAS.
DUCATO/ DAILY/ JUMPER/ BOXER 2.8 ARO 16
M-16X1,50X31 CH-24

4938
PARAFUSO RODA ZINCADO PRETO CÔNICO
DIANT./TRAS. RAMPAGE - RAM M-14X1,50X29
CH-17

4939
PARAFUSO RODA ZINCADO CÔNICO DIANT./TRAS.
CORSA/ CELTA/ PRISMA/ AGILE/ ASTRA/ MERIVA/
ZAFIRA M-12X1,50X22 CH-17

4940
PARAFUSO RODA ZINCADO CÔNICO DIANT./TRAS.
CLIO/ SANDERO/ LOGAN/ SYMBOL/ DUSTER/
CAPTUR/ FLUENCE M-12X1,50X23 CH-17

4941
PARAFUSO RODA ZINCADO PRETO CÔNICO
DIANT./TRAS. 206/ 207/ 208/ 307/ HOGGAR/
C3/ XSARA/ DS 3 M-12X1,25X26 CH-17

4942
PARAFUSO RODA ZINCADO ESFÉRICO DIANT./
TRAS. SPRINTER 97/... M-14X1,50X34 CH-19

4943
JOGO PARAF. RODA CROMADO ESFÉRICO DIANT./
TRAS. FUSCA/ BRASILIA/ KOMBI M-14X1,50X25
CH-19 (16PC)

4944
JOGO PARAF. RODA CROMADO ESFÉRICO
DIANT./TRAS KOMBI/ BRASILIA - LONGO
M-14X1,50X35 CH-19 (16PC)

4945
JOGO PARAF. RODA CROMADO ESFÉRICO DIANT./
TRAS. GOL/ PARATI/ SAVEIRO/ VOYAGE/ SANTA-
NA 96/... M-12X1,50X25 CH-17 (16PC)

4946
JOGO PARAF. RODA CROMADO CÔNICO-MULTI
DIANT./TRAS. GOL/ PARATI/ SAVEIRO/ VOYAGE/
SANTANA/ CORSA/ CELTA/ PRISMA/ AGILE/
ASTRA/ MERIVA/ ZAFIRA M-12X1,50X24,5
CH-17 (16PC)

4947
JOGO PARAF. RODA CROMADO CÔNICO-MULTI
DIANT./TRAS. GOL/ PARATI/ SAVEIRO/ VOYAGE/
SANTANA - LONGO M-12X1,50X35 CH-17
(16PC)

4948
JOGO PARAF. RODA CROMADO CÔNICO DIANT./
TRAS. FOX/ GOLF/ POLO/ SPACEFOX/ T-CROSS/
TIGUAN/ BORA 03/... M-14X1,50X28 CH-17
(20PC)

4949
JOGO PARAF. RODA CROMADO CÔNICO DIANT./
TRAS. UNO/ NOVO UNO/ PALIO/ SIENA/ STRADA
/ FIORINO/ GRAND SIENA/ IDEA/ ARGO/ CRONOS/
PULSE M-12X1,25X23 CH-19 (16PC)

4950
JOGO PARAF. RODA CROMADO CÔNICO DIANT./
TRAS. UNO/ PALIO/ SIENA/ STRADA/ PUNTO/
BRAVA/ MAREA/ IDEA/ TIPO M-12X1,25X28
CH-19 (16PC)

4951
JOGO PARAF. RODA CROMADO CÔNICO DIANT./
TRAS. LINHA FIAT TODOS - EXTRA LONGO
M-12X1,25X38 CH-19 (16PC)

4952
JOGO PARAF. RODA CROMADO CÔNICO DIANT./
TRAS. LINHA FIAT TODOS C/ ARRUELA OSCILANTE
M-12X1,25X27 CH-19 (16PC)

4953
PARAF. RODA CROMADO ESFÉRICO DIANT./TRAS.
FUSCA/ BRASILIA/ KOMBI M-14X1,50X25 CH-19

4954
PARAF. RODA CROMADO CÔNICO-MULTI DIANT./
TRAS. GOL/ PARATI/ SAVEIRO/ VOYAGE/ SAN-
TANA/ CORSA/ CELTA/ PRISMA/ AGILE/ ASTRA/
MERIVA/ ZAFIRA M-12X1,50X24,5 CH-17



4955
PARAF. RODA CROMADO CÔNICO DIANT./TRAS. FOX/ GOLF/ POLO/ SPACEFOX/ T-CROSS/ TIGUAN/ BORA 03/... M-14X1,50X28 CH-17



4956
PARAF. RODA CROMADO CÔNICO DIANT./TRAS. UNO/ NOVO UNO/ PALIO/ SIENA/ STRADA / FIORINO/ GRAND SIENA/ IDEA/ ARGO/ CRONOS/ PULSE M-12X1,25X23 CH-19



4957
PARAF. RODA CROMADO CÔNICO DIANT./TRAS. UNO/ PALIO/ SIENA/ STRADA/ PUNTO/ BRAVA/ MAREA/ IDEA/ TIPO M-12X1,25X28 CH-19



4958
PARAF. RODA CROMADO CÔNICO DIANT./TRAS. LINHA FIAT TODOS – EXTRA LONGO M-12X1,25X38 CH-19 (16PC)



4959
PARAF. RODA CROMADO CÔNICO DIANT./TRAS. TORO 15/... M-12X1,25X26 CH-17



4960
PARAF. RODA CROMADO CÔNICO DIANT./TRAS. RENEGADE/ COMPASS 15/... M-12X1,25X22,5 CH-17





4926
ARRUELA CÔNICA FIXAÇÃO CALOTA RODA UNIVERSAL

PARAFUSO ANTI-FURTO
Roda



4961
JOGO PARAF. ANTI-FURTO M-14X1,50X28 CH-17/19 GOLF/AUDI/FOX (4+1)









4962
JOGO PARAF. ANTI-FURTO MULTI M-12X1,50X26 CH-17/19 VW/ GM/ FORD/ RENAULT (4+1)





4963
JOGO PARAF. ANTI-FURTO M-12X1,25X26 CH-17/19 FIAT/PEUGEOT (4+1)

4964
JOGO PORCA ANTI-FURTO M-12X1,50 CH-19/21 GM/FORD (4+1)



4965
PORCA RODA AGRALE 7000/ VOLARE A6
M-16X1,50 CH-27



4966
PORCA RODA M.BENZ 709/ 712C/ 812/ 912/
C914 M-18X1,50 CH-24 H19



4967
PORCA RODA SCANIA 110/ 111/ L110/ LK111
M-18X2,00 CH-27 H20,4



4968
PORCA RODA M.BENZ 1111/ 1113 VOLKS
11.130/ 11.140/ 12.140 CARRETA RANDON
RAIADA M-20X1,50 CH-27 H21



4969
PORCA RODA M.BENZ 1111/ 1113 RANDON
RAIADA M-20X1,50 CH-27 H28



4970
PORCA RODA M.BENZ 1111/ 1113 M-20X1,50
CH-30 H28



4971
PORCA RODA (ARRUELA OSCILANTE) DIANT./
TRAS. M.BENZ-1111/ 1113/ ACCELO 715C/
815/ 915C VOLKS-11.130 A 12.170 FORD
CARGO-1113 A 12.814 TRATORES VALTRA/
VALMET M-20X1,50 CH-30 H27



4972
PORCA RODA CARRETA RANDON/ FACCHINI/
IDEROL/ KRONE VOLVO N10/ NL10/ N12/ NL12
SCANIA T112/ T113 M-20X2,00 CH-27 H21



4973
PORCA RODA M.BENZ 1313/ 1513/ 1519/ 2013
M-22X1,50 CH-27 H28 BAIXA



4974
PORCA RODA M.BENZ 1313/ 1513/ 1519/ 2638
M-22X1,50 CH-30 H28 ALTA



4975
PORCA RODA (ARRUELA OSCILANTE) M.BENZ
1313 A 2654 ACTROS/ ATEGO/ AXOR/
EUROCARGO/ EUROTEC/ STRALIS/ CARRETAS
RANDON/ RECRUSUL M-22X1,50 CH-32 H29



4976
PORCA RODA (ARRUELA OSCILANTE) M.BENZ LS
1313 A 2654 CARRETAS RANDON M-22X1,50
CH-32 H33



4977
PORCA RODA (ARRUELA OSCILANTE)
M.BENZ-1313 A 2013 CARGO-1313 A 2630
VOLKS/ONIBUS-13.180 A 40.300 CARRETAS-
-RANDON/ NOMA/ FNV/ TECTRAN VOLVO-FH/
FM/ NH/ VM M-22X1,50 CH-33 H30



4978
PORCA RODA (ARRUELA OSCILANTE) SCANIA
SERIES P/G/R ONIBUS F/K/L CARRETAS GUERRA
7/8X11BSF CH-33 H27





4979
PARAFUSO RODA DIANT. AGRALE 7000
M-16X1,50X63 / 70



4980
PARAFUSO RODA DIANT. VOLARE A6
M-16X1,50X73 / 80



4981
PARAFUSO RODA TRAS. VOLARE A6/ AGRALE
7000 M-16X1,50X73 / 80



4982
PARAFUSO RODA DIANT. VOLARE A8-8500
M-18X1,50X72,5 / 81



4983
PARAFUSO RODA TRAS. VOLARE A8-8500
M-18X1,50X82 / 91



4984
PARAFUSO RODA DIANT. VOLKS 6.80/ 6.90/
7.90/ 7.100/ 7.110/ 7.120/ 8.120/ 8.150/
9.150 M-18X1,50X70 / 79



4985
PARAFUSO RODA TRAS. VOLKS 6.80/ 6.90/
7.90/ 7.100/ 7.110/ 7.120/ 8.120/ 8.150/
9.150 FORD CARGO 814/ 815 M-18X1,50X80
/ 89



4986
PARAFUSO RODA TRAS. F-4000 99/... VOLKS
7.100/ 8.100/ 8.140/ONIBUS FORD CARGO
814/ 815 M-18X1,50X90 / 99



4921
PARAFUSO RODA DIANT. VOLKS DELIVERY
9.170/ 9.180/ 11.180/ 11.410/ 13.180 18/...
M-18X1,50X80 / 89



4919
PARAFUSO RODA TRAS. VOLKS DELIVERY
9.170/ 9.180/ 11.180/ 11.410/ 13.180 18/...
M-18X1,50X90 / 99



4987
PARAFUSO RODA DIANT. VOLKS 14.150
A 40.300 FORD CARGO 1215 A 12.814
M-20X1,50X80 / 91



4988
PARAFUSO RODA DIANT. VOLKS 12.140H/
16.210/ 16.220 FORD CARGO 1113/ 1114/
1117 M-20X1,50X90 / 97,5



4989
PARAFUSO RODA TRAS. VOLKS 14.150 A
40.300 FORD CARGO 1215/ 1218/ 12.814/
14140H M-20X1,50X90 / 101



4990
PARAFUSO RODA TRAS. (RECARILHO MEIO)
VOLKS 12.140H A 16.220 FORD CARGO 1113/
1114/ 1117 M-20X1,50X92 / 99,5



4991
PARAFUSO RODA TRAS. VOLKS 16.210
A 16.220 FORD CARGO 1313 A 2217
M-22X1,50X88 / 96



4992
PARAFUSO RODA DIANT. VOLKS 14.150
A 26.300 FORD CARGO 1313 A 2630
M-22X1,50X91 / 102



4993
PARAFUSO RODA TRAS. VOLKS 13.170
A 40.300 FORD CARGO 1313 A 2622
M-22X1,50X95 / 103







4994
PARAFUSO RODA TRAS. VOLKS 14.150 A
40.300 FORD CARGO 1313 A 2630 VOLVO
VM DIANTEIRA P/ RODA DE ALUMINIO
M-22X1,50X97,5 / 108,5



4995
PARAFUSO RODA TRAS. (RODA ALUMÍNIO)
VOLKS 16.210 A 16.220 FORD CARGO 1313 A
2630 M-22X1,50X116 / 125



4996
PARAFUSO RODA DIANT. M.BENZ 709/ 710/
711/ 712C/ 812/ 912/ 914C CUBO RODA
MOTRIZ KOMATSU D50-A M-18X1,50X60 / 68

 <p>4997 PARAFUSO RODA TRAS. M.BENZ 709/ 710/ 711/ 712C/ 812/ 912/ 914C M-18X1,50X64 / 72</p>	 <p>4998 PARAFUSO RODA TRAS. M.BENZ 709/ 710/ 711/ 712C/ 812/ 912/ 914C M-18X1,50X75 / 83</p>	 <p>4999 PARAFUSO RODA DIANT. M.BENZ ACCELO 715C/ 915C M-20X1,50X59 / 69</p>	 <p>5000 PARAFUSO RODA TRAS. M.BENZ ACCELO 715C/ 915C M-20X1,50X95 / 104</p>
 <p>5001 PARAFUSO RODA DIANT. M.BENZ 1111/ 1113 M-20X1,50X70 / 78</p>	 <p>5002 PARAFUSO RODA TRAS. M.BENZ 1111/ 1113 M-20X1,50X80 / 88</p>	 <p>5003 PARAFUSO RODA TRAS. M.BENZ 1111/ 1113 TRUCK M-20X1,50X89 / 97</p>	 <p>5004 PARAFUSO RODA TRAS. M.BENZ 1111/ 1113 TRUCK M-20X1,50X100 / 108</p>
 <p>5005 PARAFUSO RODA TRAS. M.BENZ 1111/ 1113 TRUCK M-20X1,50X110 / 118</p>	 <p>5006 PARAFUSO RODA DIANT. (ESPIRAL) M.BENZ ACTROS/ AXOR/ ATEGO/ ONIBUS 10/... M-22X1,50X68 / 78,5</p>	 <p>5007 PARAFUSO RODA DIANT. (ESPIRAL) M.BENZ AXOR/ ATEGO 12/... M-22X1,50X77 / 87,5</p>	 <p>5008 PARAFUSO RODA DIANT. M.BENZ 1313/ 1513/ 1519/ 2013 M-22X1,50X72 / 82</p>
 <p>5009 PARAFUSO RODA DIANT. M.BENZ 1313/ 1519/ 2013 M-22X1,50X77 / 87</p>	 <p>5010 PARAFUSO RODA TRAS. (ESPIRAL) M.BENZ ATEGO 12/... AXOR 11/... M-22X1,50X86 / 96,5</p>	 <p>5011 PARAFUSO RODA TRAS. M.BENZ 1313/ 1519/ 2013 M-22X1,50X89 / 99</p>	 <p>5012 PARAFUSO RODA TRAS. (ESPIRAL) M.BENZ ACTROS 10/... M-22X1,50X92 / 102,5</p>
 <p>5013 PARAFUSO RODA TRAS. M.BENZ 1313/ 1513/ 1519/ 2013 M-22X1,50X98 / 108</p>	 <p>5014 PARAFUSO RODA TRAS. (ESPIRAL) M.BENZ ACTROS/ ATEGO/ AXOR/ ONIBUS 12/... M-22X1,50X98 / 108,5</p>	 <p>5015 PARAFUSO RODA DIANT. M.BENZ ATEGO 04/11 TRAS. AXOR 04/10 M-22X,50X90 / 100</p>	 <p>5016 PARAFUSO RODA TRAS. M.BENZ 1612/ 1924/ 1935/ 1938/ 1941/ LS 1632/ 2638 M-22X1,50X110 / 120,5</p>



5017
PARAFUSO RODA TRAS. M.BENZ 1618/
LS 1632/ 1638/ LS 2638/ 2640/ 2654
M-22X1,50X120 / 130



5018
PARAFUSO RODA TRAS. M.BENZ 1618/
LS 1632/ 1638/ LS 2638/ 2640/ 2654
M-22X1,50X135 / 145



5019
PARAFUSO RODA TRAS. (ESPIRAL) M.BENZ
ACTROS/ ATEGO/ AXOR/ ONIBUS 12/...
M-22X1,50X110 120,5



5020
PARAFUSO RODA TRAS. (ESPIRAL) M.BENZ
ACTROS/ ATEGO/ AXOR 12/... M-22X1,50X115
/ 125,5



5021
PARAFUSO RODA TRAS. (C/ FURO) SCANIA 110/
111/ L110/ LK111 CARRETA RANDON .../84
M-18X2,00X85 / 94



5022
PARAFUSO RODA DIANT. SCANIA SERIES P/G/R
08/... 7/8X11BSFX85 / 95,5



5023
PARAFUSO RODA TRAS. SCANIA SERIES P/G/R
08/... 7/8X11BSFX102 / 114



5024
PARAFUSO RODA DIANT. VOLVO CAMINHOES VM
M-22X1,50X69,5 / 80



5025
PARAFUSO RODA DIANT. VOLVO FH/ FM/ NH
M-22X1,50X88,5 / 99



5026
PARAFUSO RODA TRAS. VOLVO FH/ FM/ NH
M-22X1,50X113,5 / 124



5027
PARAFUSO RODA DIANT. EUROCARGO/
EUROTEC/ STRALIS/ TRACTOR/ CURSOR
M-22X1,50X90 / 99



5028
PARAFUSO RODA TRAS. EUROCARGO/ EUROTEC/
STRALIS/ TRACTOR/ CURSOR M-22X1,50X98
/ 107



5029
PARAFUSO RODA (C/ FURO) CARRETA RANDON/
FACCHINI/ IDEROL/ KRONE M-20X2,00X75 / 93



5030
PARAFUSO RODA (C/ FURO) CARRETA RANDON/
FACCHINI/ IDEROL/ KRONE M-20X2,00X80 / 101



5031
PARAFUSO RODA (C/ FURO) CARRETA RANDON/
NOMA M-20X1,50X80 / 101



5032
PARAFUSO RODA (C/ RECARILHO) CAR-
RETA RANDON/ FACCHINI/ IDEROL/ KRONE
M-22X1,50X96 / 107



5033
PARAFUSO RODA (C/ RECARILHO) CARRETA
RANDON FREIO DISCO 88/... M-22X1,50X110,5
/ 120,5



5034
PARAFUSO RODA CARRETA GUERRA FREIO A
DISCO 7/8X11BSFX100 / 110,5



5035

ARRUELA CÔNICA M-18 LISA M.BENZ 709/ 710/
711/ 712C/ 812/ 912/ 914C



5036

ARRUELA CÔNICA M-18 PRESSÃO M.BENZ 709/
710/ 711/ 712C/ 812/ 912/ 914C



5037

ARRUELA CÔNICA M-20 LISA M.BENZ 1111/
1113



5038

ARRUELA CÔNICA M-20 PRESSÃO M.BENZ 1111/
1113



5039

ARRUELA CÔNICA M-22 LISA M.BENZ 1313/
1315/ 1519/ 2013/ O 362



5040

ARRUELA CÔNICA M-22 PRESSÃO M.BENZ
1313/ 1315/ 1519/ 2013/ O 362

Roda

KIT PARAFUSO DE RODA C/ PORCA - PESADO



5041

JOGO PARAF. RODA DIANT. AGRALE 7000
M-16X1,50X63 / 70 CH-27

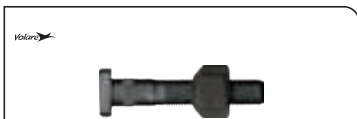

5042

JOGO PARAF. RODA DIANT. VOLARE A6
M-16X1,50X73 / 80 CH-27



5043

JOGO PARAF. RODA TRAS. VOLARE A6/ AGRALE
7000 M-16X1,50X73 / 80 CH-27



5044

JOGO PARAF. RODA DIANT. VOLARE A8-8500
M-18X1,50X72,5 / 81 CH-27 OSCILANTE



5045

JOGO PARAF. RODA TRAS. VOLARE A8-8500
M-18X1,50X82 / 91 CH-27 OSCILANTE



5046

JOGO PARAF. RODA DIANT. VOLKS 6.80/ 6.90/
7.90/ 7.100/ 7.110/ 7.120/ 8.120/ 8.150/
9.150 M-18X1,50X70 / 79 CH-27



5047

JOGO PARAF. RODA TRAS. VOLKS 6.80/ 6.90/
7.90/ 7.100/ 7.110/ 7.120/ 8.120/ 8.150/
9.150 FORD CARGO 814/ 815 M-18X1,50X80
/ 89 CH-27



5048

JOGO PARAF. RODA TRAS. VOLKS 7.100/ 8.100/
8.140/ ONIBUS F-4000 99/... FORD CARGO
814/ 815 M-18X1,50X90 / 99 CH-27



4923
 JOGO PARAF. RODA DIANT. VOLKS DELIVERY 9.170/ 9.180/ 11.180/ 11.410/ 13.180 18/... M-18X1,50X80 / 89 CH-27



4922
 JOGO PARAF. RODA TRAS. VOLKS DELIVERY 9.170/ 9.180/ 11.180/ 11.410/ 13.180 18/... M-18X1,50X90 / 99 CH-27





5049
 JOGO PARAF. RODA DIANT. VOLKS 14.150 A 40.300 FORD CARGO 1215 A 12.814 M-20X1,50X80 / 91 CH-30 OSCILANTE





5050
 JOGO PARAF. RODA DIANT. VOLKS 12.140H/ 16.210/ 16.220 FORD CARGO 1113/ 1114/ 1117 M-20X1,50X90 / 97,5 CH-30 OSCILANTE





5051
 JOGO PARAF. RODA TRAS. VOLKS 14.150 A 40.300 FORD CARGO 1215/ 1218/ 12.814/ 14.140H M-20X1,50X90 / 101 CH-30 OSCILANTE





5052
 JOGO PARAF. RODA TRAS. (RECARILHO MEIO) VOLKS 12.140H A 16.220 FORD CARGO 1113/ 1114/ 1117 M-20X1,50X92 / 99,5 CH-30 OSCILANTE





5053
 JOGO PARAF. RODA TRAS. VOLKS 16.210 A 16.220 FORD CARGO 1313 A 2217 M-22X1,50X88 / 96 CH-33 OSCILANTE





5054
 JOGO PARAF. RODA DIANT. VOLKS 14.150 A 26.300 FORD CARGO 1313 A 2630 M-22X1,50X91 / 102 CH-33 OSCILANTE





5055
 JOGO PARAF. RODA TRAS. VOLKS 13.170 A 40.300 FORD CARGO 1313 A 2622 M-22X1,50X95 / 103 CH-33 OSCILANTE





5056
 JOGO PARAF. RODA TRAS. VOLKS 14.150 A 40.300 FORD CARGO 1313 A 2630 VOLVO VM DIANTEIRA P/ RODA DE ALUMÍNIO M-22X1,50X97,5 / 108,5 CH-33 OSCILANTE





5057
 JOGO PARAF. RODA TRAS. (RODA ALUMÍNIO) VOLKS 16.210 A 16.220 FORD CARGO 1313 A 2630 M-22X1,50X116 / 125 CH-33 OSCILANTE





5058
 JOGO PARAF. RODA DIANT. M.BENZ 709/ 710/ 711/ 712C/ 812/ 912/ 914C CUBO RODA MOTRIZ KOMATSU D50-A M-18X1,50X60 / 68 CH-24



5059
 JOGO PARAF. RODA TRAS. M.BENZ 709/ 710/ 711/ 712C/ 812/ 912/ 914C M-18X1,50X64 / 72 CH-24



5060
 JOGO PARAF. RODA TRAS. M.BENZ 709/ 710/ 711/ 712C/ 812/ 912/ 914C M-18X1,50X75 / 83 CH-24



5061
 JOGO PARAF. RODA DIANT. M.BENZ ACCELO 715C/ 915C M-20X1,50X59 / 69 CH-30 OSCILANTE



5062
 JOGO PARAF. RODA TRAS. M.BENZ ACCELO 715C/ 915C M-20X1,50X95 / 104 CH-30 OSCILANTE



5063
 JOGO PARAF. RODA DIANT. M.BENZ 1111/ 1113 M-20X1,50X70 / 78 CH-30























5064
 JOGO PARAF. RODA TRAS. M.BENZ 1111/ 1113 M-20X1,50X80 / 88 CH-30



5065
 JOGO PARAF. RODA TRAS. M.BENZ 1111/ 1113 TRUCK M-20X1,50X89 / 97 CH-30





5066
 JOGO PARAF. RODA TRAS. M.BENZ 1111/ 1113 TRUCK M-20X1,50X100 / 108 CH-30

 <p>5067 JOGO PARAF. RODA TRAS. M.BENZ 1111/ 1113 TRUCK M-20X1,50X100 / 108 CH-30 OSCILANTE</p>	 <p>5068 JOGO PARAF. RODA TRAS. M.BENZ 1111/ 1113 TRUCK M-20X1,50X110 / 118 CH-30 OSCILANTE</p>	 <p>5069 JOGO PARAF. RODA DIANT. (ESPIRAL) M.BENZ ACTROS/ AXOR/ ATEGO/ ONIBUS 10/... M-22X1,50X68 / 78,5 CH-32 OSCILANTE</p>	 <p>5070 JOGO PARAF. RODA DIANT. (ESPIRAL) M.BENZ AXOR/ ATEGO 12/... M-22X1,50X77 / 87,5 CH-32 OSCILANTE</p>
 <p>5071 JOGO PARAF. RODA DIANT. M.BENZ 1313/ 1513/ 1519/ 2013 M-22X1,50X72 / 82 CH-30</p>	 <p>5072 JOGO PARAF. RODA DIANT. M.BENZ 1313/ 1519/ 2013 M-22X1,50X77 / 87 CH-27</p>	 <p>5073 JOGO PARAF. RODA DIANT. M.BENZ 1313/ 1519/ 2013 M-22X1,50X77 / 87 CH-32 OSCILANTE</p>	 <p>5074 JOGO PARAF. RODA TRAS. (ESPIRAL) M.BENZ ATEGO 12/... AXOR 11/... M-22X1,50X86 / 96,5 CH-32 OSCILANTE</p>
 <p>5075 JOGO PARAF. RODA TRAS. M.BENZ 1313/ 1519/ 2013 M-22X1,50X89 / 99 CH-30</p>	 <p>5076 JOGO PARAF. RODA TRAS. M.BENZ 1313/ 1519/ 2013 M-22X1,50X89 / 99 CH-32 OSCILANTE</p>	 <p>5077 JOGO PARAF. RODA TRAS. (ESPIRAL) M.BENZ ACTROS 10/... M-22X1,50X92 / 102,5 CH-32 OSCILANTE</p>	 <p>5078 JOGO PARAF. RODA TRAS. M.BENZ 1313/ 1513/ 1519/ 2013 M-22X1,50X98 / 108 CH-30</p>
 <p>5079 JOGO PARAF. RODA TRAS. M.BENZ 1313/ 1513/ 1519/ 2013 M-22X1,50X98 / 108 CH-32 OSCILANTE</p>	 <p>5080 JOGO PARAF. RODA TRAS. (ESPIRAL) M.BENZ ACTROS/ ATEGO/ AXOR/ ONIBUS 12/... M-22X1,50X98 / 108,5 CH-32 OSCILANTE</p>	 <p>5081 JOGO PARAF. RODA DIANT. M.BENZ ATEGO 04/11 TRAS. AXOR 04/10 M-22X,50X90 / 100 CH-32 OSCILANTE</p>	 <p>5082 JOGO PARAF. RODA TRAS. M.BENZ 1612/ 1924/ 1935/ 1938/ 1941/ LS 1632/ 2638 M-22X1,50X110 / 120,5 CH-32 OSCILANTE</p>
 <p>5083 JOGO PARAF. RODA TRAS. M.BENZ 1618/ LS 1632/ 1638/ LS 2638/ 2640/ 2654 M-22X1,50X120 / 130 CH-32 OSCILANTE</p>	 <p>5084 JOGO PARAF. RODA TRAS. M.BENZ 1618/ LS 1632/ 1638/ LS 2638/ 2640/ 2654 M-22X1,50X135 / 145 CH-32 OSCILANTE</p>	 <p>5085 JOGO PARAF. RODA TRAS. (ESPIRAL) M.BENZ ACTROS/ ATEGO/ AXOR/ ONIBUS 12/... M-22X1,50X110 120,5 CH-32 OSCILANTE</p>	 <p>5086 JOGO PARAF. RODA TRAS. (ESPIRAL) M.BENZ ACTROS/ ATEGO/ AXOR 12/... M-22X1,50X115 / 125,5 CH-32 OSCILANTE</p>



5087
 JOGO PARAF. RODA TRAS. (C/ FURO) SCANIA 110/ 111/ L110/ LK111 CARRETA RANDON .../84 M-18X2,00X85 / 94 CH-27



5088
 JOGO PARAF. RODA DIANT. SCANIA SERIES P/G/R 08/... 7/8X11BSFX85 / 95,5 CH-33



5089
 JOGO PARAF. RODA TRAS. SCANIA SERIES P/G/R 08/... 7/8X11BSFX102 / 114 CH-33



5090
 JOGO PARAF. RODA DIANT. VOLVO CAMINHOS VM M-22X1,50X69,5 / 80 CH-33 OSCILANTE



5091
 JOGO PARAF. RODA DIANT. VOLVO FH/ FM/ NH M-22X1,50X88,5 / 99 CH-33 OSCILANTE



5092
 JOGO PARAF. RODA TRAS. VOLVO FH/ FM/ NH M-22X1,50X113,5 / 124 CH-33 OSCILANTE



5093
 JOGO PARAF. RODA DIANT. EUROCARGO/ EUROTEC/ STRALIS/ TRACTOR/ CURSOR M-22X1,50X90 / 99 CH-32 OSCILANTE



5094
 JOGO PARAF. RODA TRAS. EUROCARGO/ EUROTEC/ STRALIS/ TRACTOR/ CURSOR M-22X1,50X98 / 107 CH-32 OSCILANTE



5095
 JOGO PARAF. RODA (C/ FURO) CARRETA RANDON/ FACCHINI/ IDEROL/ KRONE M-20X2,00X75 / 93 CH-27



5096
 JOGO PARAF. RODA (C/ FURO) CARRETA RANDON/ FACCHINI/ IDEROL/ KRONE M-20X2,00X80 / 101 CH-27



5097
 JOGO PARAF. RODA (C/ FURO) CARRETA RANDON/ NOMA M-20X1,50X80 / 101 CH-27



5098
 JOGO PARAF. RODA (C/ RECARILHO) CARRETA RANDON/ FACCHINI/ IDEROL/ KRONE M-22X1,50X96 / 107 CH-32 OSCILANTE



5099
 JOGO PARAF. RODA (C/ RECARILHO) CARRETA RANDON FREIO DISCO 88/... M-22X1,50X110,5 / 120,5 CH-32 OSCILANTE



5100
 JOGO PARAF. RODA CARRETA GUERRA FREIO A DISCO 7/8X11BSFX100 / 110,5 CH-33



etaniz



DESENGRIPANTE 300ML/150G

• DESCRIÇÃO:

Produto de alta qualidade, desenvolvido para reduzir o atrito e, conseqüentemente, o desgaste entre partes metálicas, eliminando ruídos e lubrificando por completo devido ao seu alto poder penetrante. Foi formulado para penetrar e remover graxa, poeira, depósitos de carbono e corrosão. Lubrificante, penetrante e preventivo contra ferrugem.

• FINALIDADE:

Aplicações típicas incluem soltar peças engripadas por oxidação como porcas, parafusos, ferramentas, etc. Na indústria: lubrifica e protege máquinas, ferramentas, esteiras rolantes, eixos, motores elétricos desligados, engrenagens, polias e outros equipamentos industriais, partes mecânicas de automóveis e rolamentos. Na casa: fechaduras, dobradiças, trincos, ferramentas, eletrodomésticos, máquinas de costura, máquinas de lavar e outras. No lazer: equipamentos de academia, pesca e náuticos, bicicletas e qualquer peça metálica. Em locais de difícil acesso, utilize o tubo prolongador.

• BENEFÍCIOS:

- Fórmula de gelinho, permite alta aderência imediatamente após a aplicação
- Pode ser usado em plásticos e borrachas, não agride pintura
- Elimina a umidades, lubrifica e protege

• PODE SER APLICADO EM:

- Aço, Alumínio, Azulejos • Bicicletas, Concessionárias • Dobradiças, Eixos • Eletrodomésticos, Equipamentos de pesca e náuticos
- Esteiras, Fechaduras, Ferramentas • Ferro, Geradores • Inox, Máquinas, Máquinas de costura • Metais, Motores, Parafusos, Porcas

CODIGO: 1

etaniz



SILICONE SPRAY 300ML/170G

• DESCRIÇÃO:

SILICONE SPRAY é um produto desenvolvido para limpar, proteger, e renovar superfícies como painéis, partes das portas, bancos de couro e outras partes plásticas do veículo.

• FINALIDADE:

SILICONE SPRAY possui excelente poder de revitalização, trazendo de volta o brilho original de vinil, plástico e couro. Limpa peças plásticas e de borracha, protege a superfície das portas e painéis. Repele a água e a poeira, deixando a superfície protegida e com brilho natural. Possui fácil aplicação e resulta em uma superfície limpa, agradável e perfumada.

• PODE SER APLICADO EM:

- Interior dos veículos: painel, partes plásticas, de borracha
- Portas do carro
- Bancos de couro
- Fechaduras, dobradiças, trilhos de cortina e persianas

• MODO DE APLICAÇÃO:

Agite bem antes de usar. Aplique o produto na superfície limpa e seca a uma distância de aproximadamente 15 cm. Com o auxílio de um pano limpo e seco, espalhe o produto até atingir o brilho desejado. Em locais de difícil acesso, utilize o bico prolongador.

• BENEFÍCIOS:

- Revitaliza interior do carro • Renova painéis plásticos • Renova bancos de couro • Protege plásticos, borrachas e metais
- Reduz o atrito e conseqüentemente o desgaste • Previne de ruídos e barulhos • Propriedade desmoldante • Lubrifica e protege contra maresia • Atua como desmoldante para injeção termoplástica • Traz de volta o brilho
- Repele água e poeira • Aroma agradável • Qualidade premium

CODIGO: 3706

etaniz



LIMPA CONTATO 300ML/200G

• DESCRIÇÃO:

LIMPA CONTATO é um produto elaborado para ser utilizado como limpador e restaurador da continuidade elétrica em circuitos e mecanismos eletroeletrônicos, sem a necessidade da desmontagem do equipamento. Possui um excelente poder de limpeza e de umectação.

• FINALIDADE:

LIMPA CONTATO é ideal para a limpeza nos aparelhos que tenham resíduos de graxas, poeiras, e outros elementos que possam impedir a continuidade elétrica. É um produto de alta tecnologia, possui também rápida evaporação que remove alguns tipos de graxa, sujeira, óleos e outros contaminantes das superfícies dos contatos eletroeletrônicos, sem deixar nenhum resíduo.

• PODE SER APLICADO EM:

- Contatos elétricos e eletrônicos • Placas, slots e conectores • Manutenção e limpeza de computadores • Manutenção e limpeza de equipamentos elétricos e eletrônicos:

• MODO DE APLICAÇÃO:

Agite bem antes de usar. Aplique diretamente no ponto a ser lubrificado a uma distância de aproximadamente 15 cm. Em locais de difícil acesso, utilize o bico prolongador.

• BENEFÍCIOS:

- Elimina resíduos que prejudicam os contatos elétricos e eletrônicos • Recupera a condutividade dos contatos • Na maioria dos casos, dispensa a desmontagem dos equipamentos • Não propaga corrente elétrica • Limpa e seca instantaneamente • Limpador de contatos a seco • Limpa e restaura • Recupera a condutividade • Rápida evaporação • Qualidade premium

CODIGO: 3734

etaniz



DESCARBONIZANTE SPRAY 300ML/200G

• DESCRIÇÃO:

DESCARBONIZANTE SPRAY remove em poucos minutos borra, verniz e carbonização que impedem o perfeito funcionamento do sistema de alimentação de combustível do veículo.

• FINALIDADE:

Recomendada para uso automotivo, com aplicação em: corpo de borboleta, carburadores, cabeças de pistões e válvulas de motores a álcool, gasolina e flex.

• PODE SER APLICADO EM:

- Bicos injetores • Carburadores • Corpo de borboletas tbi

• INSTRUÇÕES DE USO:

Carburador: desligar a tubulação de entrada do carburador e tampar a sua extremidade. Dê partida no motor e espere até que se esgote o combustível existente no sistema. Afogar o motor puxando o afogador obstruindo a entrada de ar. Dê partida no motor por várias vezes, para que o produto circule pelo sistema. Aguarde 15 minutos aproximadamente para que o produto penetre por todo o carburador. Reconecte a mangueira de combustível, recoloca a tampa do filtro e funcione o motor, ajustando se necessário a regulagem ar/combustível. Utilize o restante do produto para realizar limpeza externa do carburador. Componentes e Peças Carbonizadas: aplique o produto em toda a volta do carburador ou nas peças desejadas, para retirar resíduos de graxas, carbonização ou sujeiras. Deixe agir por aproximadamente 15 minutos. Remova os resíduos com o auxílio de um pano ou pincel. Repita a operação para um melhor resultado. Secar os componentes. Bicos Injetores: 1- desligue a alimentação elétrica da bomba de combustível. Dê partida no motor e espere até que se esgote o combustível existente no sistema. Desligue a tubulação de entrada do tubo distribuidor de combustível. Aplique o produto na entrada do distribuidor, pulse o bico injetor ou dê partida no motor. Deixar o produto agir por 15 minutos. Religar as tubulações do sistema e alimentação elétrica da bomba de combustível. Funcionar o motor acelerando rapidamente por várias vezes. Para limpeza rápida com o veículo em funcionamento: 2- desconecte a parte da mangueira que está ligada no tbi/corpo de borboleta (mangueira que sai da caixa do filtro de ar até o tbi/corpo de borboleta). Funcione o veículo até 50% do curso do acelerador ou 4.000 rpm. Em seguida aplique os descarbonizante na entrada do corpo de borboleta por 10 segundos e interrompa por 10 segundos de forma repetitiva por 10 vezes mantendo sempre a rotação em 4.000 rpm. Após terminar o processo ligue a mangueira da tomada de ar e deixe o veículo funcionando por 5 minutos na marcha lenta.

CODIGO: 3732

etaniz



GRAXA DE LITIO AZUL SPRAY 300ML/170G

• DESCRIÇÃO:

Graxa de Lítio Azul é formulada à base de sabão de Lítio com óleo básico parafínico. Possui resistência a água, ação anticorrosiva, resistência à oxidação, estabilidade mecânica, resistente a força centrífuga e altas temperaturas. Possui ponto de gota de 185°C.

• FINALIDADE:

Recomendada para uso industrial (mancais simples, rolamentos, acoplamento flexíveis, partes móveis de máquinas e pequenas caixas de engrenagem), automóveis (cubos de roda, juntas estriadas, eixo de cardans, fechaduras e pinos de capo). O Instruções de Uso: agite bem a embalagem e aplique sobre a superfície limpa, direcionando o jato para as partes a serem lubrificadas. Utilize o prolongador em locais de difícil acesso.

• BENEFÍCIOS:

• Alto poder de penetração • Forte aderência • Repele água doce e salgada • Forte resistência à oxidação • Protege contra corrosão e desgaste • Resistente a temperatura até 185°C • Não esparrama, derrete, escorre, sai com água ou congela • Reduz rangidos, atritos e estalos • Tem durabilidade e fixa em qualquer tipo de metal

• PODE SER APLICADO EM:

- Uso automotivo, caseiro, marítimo e comercial
- Pinos
- Rolamentos
- Eixos
- Cabos
- Qualquer tipo de metal
- Engrenagens
- Correntes
- Dobradiças

CODIGO: 9767

etaniz



GRAXA DE LITIO BRANCA 300ML/170G

• DESCRIÇÃO:

Graxa de Lítio Branca é formulada à base de sabão de Lítio com óleo básico parafínico. Possui resistência a água, ação anticorrosiva, resistência à oxidação, estabilidade mecânica, resistente a força centrífuga e altas temperaturas. Possui ponto de gota de 185°C.

• FINALIDADE:

Recomendada para uso industrial (mancais simples, rolamentos, acoplamento flexíveis, partes móveis de máquinas e pequenas caixas de engrenagem), automóveis (cubos de roda, juntas estriadas, eixo de cardans, fechaduras e pinos de capo). O Instruções de Uso: agite bem a embalagem e aplique sobre a superfície limpa, direcionando o jato para as partes a serem lubrificadas. Utilize o prolongador em locais de difícil acesso.

• BENEFÍCIOS:

• Alto poder de penetração • Forte aderência • Repele água doce e salgada • Forte resistência à oxidação • Protege contra corrosão e desgaste • Resistente a temperatura até 185°C • Não esparrama, derrete, escorre, sai com água ou congela • Reduz rangidos, atritos e estalos • Tem durabilidade e fixa em qualquer tipo de metal

• PODE SER APLICADO EM:

- Uso automotivo, caseiro, marítimo e comercial
- Pinos
- Rolamentos
- Eixos
- Cabos
- Qualquer tipo de metal
- Engrenagens
- Correntes
- Dobradiças

CODIGO: 9768

etaniz



GRAFITE SPRAY 300ML/180G

• DESCRIÇÃO:

GRAFITE SPRAY foi desenvolvido visando uma fácil aplicação em locais de difícil acesso, atua como lubrificante seco.

• INSTRUÇÕES DE USO:

Agite bem antes de usar, aplique o produto na superfície desejada formando uma camada lubrificante. Em locais de difícil acesso utilize o prolongador. Usa-se aonde possa reduzir o atrito entre as peças tais como metal com nylon, metal com borracha, vidro com borracha, nylon com nylon, borracha com borracha.

• PODE SER APLICADO EM:

- Canaletas de vidros
- Fechaduras
- Portões
- Máquinas
- Cadeados
- Portas
- Trilhos

CODIGO: 3710

etaniz



VASELINA SPRAY 300ML/180G

• DESCRIÇÃO:

VASELINA SPRAY é formulada a base de parafinas selecionadas com óleos básicos parafínicos, possui resistência à água, proteção contra a oxidação e um alto poder de lubrificação.

• INSTRUÇÕES DE USO:

Aplicação: casa, indústria e automóveis, coxins de motores, coxins de máquinas, coxins de caixa de transmissão, buchas de balança/bandeja e sapata, batentes e coifas de amortecedores. Instruções de Uso: agite bem antes de usar, aplique o produto na superfície desejada formando uma camada lubrificante, em locais de difícil acesso utilize o prolongador.

• VANTAGENS:

- Elimina rangidos
- Forma película protetora
- Hidrorepelente

CODIGO: 9772

etaniz

LIMPA AR CONDICIONADO GRANADA 300ML/170G



• DESCRIÇÃO:

LIMPA AR CONDICIONADO GRANADA foi desenvolvido para a limpeza no sistema de ar condicionado. Utilizando o sistema de trava formando uma névoa no local aplicado.

• MODO DE APLICAÇÃO:

Aplicação: interior de veículos que possuam sistema de ar condicionado. Instruções de Uso: (1) ligue o carro e o (2) sistema de ar no modo de circulação interna. (3) Posicione a chave ou botão de temperatura no frio e a (4) ventilação no máximo. (5) Direcione o ar para as saídas frontais do painel. (6) Posicione a lata sobre o tapete do passageiro em baixo do painel com o jato direcionado para a parte de circulação do ar, pressione a válvula até travar e deixe vaporizar por 2 minutos, após abra a porta do veículo e posicione o seletor de temperatura no quente no máximo, feche a porta rapidamente e mantenha funcionando por mais 2 minutos. Fique fora do veículo e mantenha o mesmo ligado e fechado, durante o processo. (7) Após 4 min da aplicação abra as janelas e deixe ventilar por mais 30 minutos. Para uma limpeza mais eficiente do ar condicionado deve-se trocar sempre o filtro da cabine antes de iniciar o processo, recomendado fazer limpeza 4 vezes ao ano.

• BENEFÍCIOS:

- Ajuda na limpeza e manutenção da caixa evaporadora de dutos de ar condicionado

LAVANDA CODIGO:3742
CARRO NOVO CODIGO:3743
ERVAS CODIGO:3744
AIR FRESH CODIGO:3745

etaniz

LIMPA FREIOS 300ML/180G



• DESCRIÇÃO:

Desenvolvido especialmente para desengordurar e limpar resíduos do sistema de freios, eliminando chiados causados pela oleosidade.

• MODO DE APLICAÇÃO:

Agite bem a embalagem antes e durante o uso e aplique nos discos dos freios a uma distância aproximada de 20cm. Se necessário, repita a operação.

Atenção: Evite o contato com a pintura do veículo, caso isso ocorra, aplique um jato de água sem esfregar.

• BENEFÍCIOS:

- Desengraxa
- Elimina resíduos e oleosidade dos discos e tambores

CODIGO: 3921

etaniz

REPARADOR DE PNEUS SPRAY 400ML/260G



• DESCRIÇÃO:

REPARADOR DE PNEUS para automóveis e motocicletas, é um produto inovador com segurança e facilidade na aplicação, pois enche e repara provisoriamente furos de até 3mm em pneus instantaneamente sem a necessidade de ferramentas especiais como macaco mecânico ou hidráulico, chave de rodas, entre outros. Agilidade em caso de emergências se comparado com o trabalho na remoção e substituição do pneu.

• INSTRUÇÕES DE USO:

Aplicação: veículos leves em geral. Instruções de Uso: agite bem a embalagem antes de usar, com uma chave ou qualquer objeto empurre por 2 ou 3 vezes a válvula do pneu para um possível destrave e conecte o extensor do Reparador de Pneus na válvula do pneu rosqueando até o final e com a embalagem na posição vertical acione de forma contínua até acabar todo o conteúdo do tubo. É necessário aplicar todo o conteúdo da embalagem. Após o uso rodar por 3km em baixa velocidade 30km/h para espalhar o produto dentro do pneu, em sequência dirigir-se a um local especializado o mais breve possível para que seja feito o reparo definitivo do pneu e para que a pressão do pneu seja calibrada adequadamente. No intervalo entre a utilização do produto e o reparo do pneu, dirigir em baixa velocidade, abaixo de 60km/h e evitar manobras bruscas. Para pneus com câmara, recomenda-se puxar a válvula do pneu para evitar que o produto escape antes que a câmara fique totalmente cheia. Obs: Em caso de rasgo do pneu, furo lateral considerável, pneu danificado ou em mau estado de conservação e quando a tala estiver encostando no aro, o produto poderá não apresentar desempenho satisfatório. O produto pode não enche completamente o pneu, dependendo da calibragem recomendada.

• VANTAGENS:

- Veda e infla pneus com furos
- Aplicação fácil e segura
- Não há necessidade de ferramentas especiais

CODIGO: 3708

etaniz

GÁS PARA MAÇARICO 400ML/215G



• DESCRIÇÃO:

Se você está procurando um gás de qualidade para alimentar o seu maçarico, o Gás para Maçarico é a escolha ideal. Este refil de gás Butano/Propano é recomendado para uma ampla variedade de modelos de maçaricos e pode ser utilizado para diversos fins, desde pequenas soldas até mesmo reparos em amassados, além de ser adequado para uso culinário.

Para utilizar o Gás para Maçarico, é importante verificar a compatibilidade do modelo do maçarico com a válvula presente na lata. É essencial seguir as instruções específicas do fabricante do maçarico. Cada modelo pode ter requisitos diferentes, portanto, certifique-se de ler e compreender as orientações fornecidas pelo fabricante antes de usar o Gás para Maçarico.

CODIGO: 9770

etaniz**GÁS FOGAREIRO 400ML/227G****• DESCRIÇÃO:**

GÁS FOGAREIRO 400ML/227G. Se você está procurando um gás de qualidade para alimentar o seu fogareiro, o Gás para Fogareiro é a escolha ideal. Este refil de gás Butano/Propano é recomendado para uma ampla variedade de modelos de fogareiros e pode ser utilizado para diversos fins. Porém é importante verificar a compatibilidade do modelo do fogareiro com a válvula presente na lata. É essencial seguir as instruções específicas do fabricante do fogareiro. Cada modelo pode ter requisitos diferentes, portanto, certifique-se de ler e compreender as orientações fornecidas pelo fabricante antes de usar o Gás para Fogareiro.

CODIGO: 9771**ADITIVO PARA COMBUSTIVEL MULTI MOTORS 200 ML****• DESCRIÇÃO:**

Para motores Flex, Etanol, Gasolina, GNV e Híbridos. Trata até 60L; limpa tanque, bicos e evita a formação de borra no tanque. Protege e lubrifica o sistema, em especial, bomba injetora, bicos cabeça de pistão, etc. Dissolve, remove e evita a formação de resíduos provenientes da combustão, proporcionando economia de combustível.

• MODO DE USAR:

Adicione o produto no tanque de combustível com no mínimo 50% da sua capacidade. Usar a cada 10.000 km. Se necessário troque o filtro de combustível de pois.

**CODIGO: 10677****ADITIVO PARA COMBUSTIVEL DIESEL 200 ML****• DESCRIÇÃO:**

Recomendado para motores Diesel. Trata até 200L; limpa tanque, bicos e evita a formação de borra no tanque. Protege e lubrifica o sistema, em especial, bomba injetora, bicos cabeça de pistão, etc. Dissolve, remove e evita a formação de resíduos provenientes da combustão, proporcionando economia de combustível.

• MODO DE USAR:

Adicione o produto no tanque de combustível com no mínimo 50% da sua capacidade. Usar a cada 10.000 km. Se necessário troque o filtro de combustível de pois.

**CODIGO: 10678**

GRAXA AZUL POTE 500G



• **CARACTERÍSTICAS::**

A Graxa Azul é fabricada à base de sabão de lítio, portando aditivos cuidadosamente escolhidos para garantir uma ótima estabilidade mecânica. Possui também resistência à água, com propriedades inibidoras de ferrugem. Suporta altas temperaturas..

• **APLICAÇÃO:**

Indicada para lubrificação de rolamentos, pinos, pivôs, cardam e lubrificação geral em ônibus, caminhões, empilhadeiras, guindastes e veículos agrícolas, exceto nos locais que trabalham com extrema pressão.

CODIGO: 11122

GRAXA BRANCA POTE 500G



• **CARACTERÍSTICAS::**

Graxa Branca de múltiplas aplicações, insolúvel em água, anticorrosiva e opera em diversas faixas de temperatura.

• **APLICAÇÃO:**

Indicada para lubrificação de engrenagens, mancais, esteiras, guias e múltiplas aplicações de embarcações.

CODIGO: 11123

GRAXA CASTANHA MULTIUSO POTE 500G



• **CARACTERÍSTICAS::**

Graxa castanha multiuso à base de óleo mineral e sabão de cálcio, utilizada para lubrificação leve. Temperatura de operação até 70°C.

• **APLICAÇÃO:**

Indicada para uso residencial, autos, motos, bike, portões, janelas, roldanas, trilhos, eixos e correntes.

CODIGO: 11124

GRAXA AZUL SACHE 80G



• **CARACTERÍSTICAS::**

A Graxa Azul é fabricada à base de sabão de lítio, portando aditivos cuidadosamente escolhidos para garantir uma ótima estabilidade mecânica. Possui também resistência à água, com propriedades inibidoras de ferrugem. Suporta altas temperaturas..

• **APLICAÇÃO:**

Indicada para lubrificação de rolamentos, pinos, pivôs, cardam e lubrificação geral em ônibus, caminhões, empilhadeiras, guindastes e veículos agrícolas, exceto nos locais que trabalham com extrema pressão.

CODIGO: 11125

GRAXA BRANCA SACHE 80G

• **CARACTERÍSTICAS::**

Graxa Branca de múltiplas aplicações, insolúvel em água, anticorrosiva e opera em diversas faixas de temperatura.

• **APLICAÇÃO:**

Indicada para lubrificação de engrenagens, mancais, esteiras, guias e múltiplas aplicações de embarcações.



CODIGO: 11126

GRAXA GRAFITADA SACHE 80G

• **CARACTERÍSTICAS::**

A graxa grafitada tem boa adesividade, proporciona redução de desgaste, eliminação de rangidos e resistência à ação da água.

• **MODO DE USAR:**

Aplique diretamente no local a ser lubrificado.



CODIGO: 11127

VASELINA INDUSTRIAL EM PASTA 3KG

• **CARACTERÍSTICAS::**

A Vaselina Sólida Industrial é utilizada para lubrificação em objetos ou locais. Ideal para superfícies que necessitam de deslizamento, substituindo a graxa e mantendo uma aplicação mais limpa..

• **MODO DE USAR:**

É um produto versátil utilizado em múltiplas aplicações como: construção Civil, Industria Automotiva e máquinas industriais.



CODIGO: 9491

PASTA PARA MONTAGEM DE PNEUS 3KG

• **CARACTERÍSTICAS::**

Produto especialmente desenvolvido para ser utilizado na montagem e desmontagem de pneus. É de fácil aplicação e com resultados imediatos, sendo indicado para pneus de carro, moto, caminhonetes, caminhões e veículos fora de estrada..

• **APLICAÇÃO:**

Remova completamente a ferrugem, sujeira e outros materiais estranhos da roda e do aro. Com um pincel, passe uma camada fina e homogênea do produto na flange do aro, base da roda e nos talões do pneu.



CODIGO: 9492

ADITIVO PARA RADIADORES CONCENTRADO ROSA



• DESCRIÇÃO:

O aditivo para radiadores concentrado foi desenvolvido para proteger o radiador contra corrosão. Evita ferrugem, incrustações e entupimento dos canais de circulação de água no motor, lubrifica a bomba d'água e protegeas mangueiras, evitando formação de bolhas de ar e melhorando a troca térmica.

• MODO DE USAR:

Comece drenando o sistema de arrefecimento; Efetue sua limpeza com água pura, caso necessário; Dilua o produto na proporção de 40% de aditivo para radiador e 60% de água desmineralizada.

1 LITRO CODIGO:10665
5 LITROS CODIGO:10671
20 LITROS CODIGO:10674

ADITIVO PARA RADIADORES CONCENTRADO AZUL



• DESCRIÇÃO:

O aditivo para radiadores concentrado foi desenvolvido para proteger o radiador contra corrosão. Evita ferrugem, incrustações e entupimento dos canais de circulação de água no motor, lubrifica a bomba d'água e protegeas mangueiras, evitando formação de bolhas de ar e melhorando a troca térmica.

• MODO DE USAR:

Comece drenando o sistema de arrefecimento; Efetue sua limpeza com água pura, caso necessário; Dilua o produto na proporção de 40% de aditivo para radiador e 60% de água desmineralizada.

1 LITRO CODIGO:10666
5 LITROS CODIGO:10672
20 LITROS CODIGO:10675

ADITIVO PARA RADIADORES CONCENTRADO VERDE



• DESCRIÇÃO:

O aditivo para radiadores concentrado foi desenvolvido para proteger o radiador contra corrosão. Evita ferrugem, incrustações e entupimento dos canais de circulação de água no motor, lubrifica a bomba d'água e protegeas mangueiras, evitando formação de bolhas de ar e melhorando a troca térmica.

• MODO DE USAR:

Comece drenando o sistema de arrefecimento; Efetue sua limpeza com água pura, caso necessário; Dilua o produto na proporção de 40% de aditivo para radiador e 60% de água desmineralizada.

1 LITRO CODIGO:10667
5 LITROS CODIGO:10673
20 LITROS CODIGO:10676

ADITIVO PARA RADIADORES SUPER CONCENTRADO ROSA



• DESCRIÇÃO:

O aditivo para radiadores super concentrado tem uma fórmula concentrada especialmente desenvolvida para melhorar o sistema de arrefecimento de motores em geral, elaborada a base de monoetilenoglicol e aditivos não tóxicos ao meio ambiente, asseguram excelente proteção contra depósitos e corrosão, prolonga a vida útil das mangueiras, lubrifica a bomba d'água, impede o super aquecimento, protege contra congelamento e evita o bloqueio dos canais do circuito de refrigeração do radiador.

• MODO DE USAR:

Comece drenando o sistema de arrefecimento; Efetue sua limpeza com água pura, caso necessário; Dilua o produto na proporção de 40% de aditivo para radiador e 60% de água desmineralizada.

1 LITRO CODIGO:10668

ADITIVO PARA RADIADORES PRONTO P/ USO ROSA



• **DESCRIÇÃO:**

O aditivo para radiadores pronto p/ uso é um composto químico desenvolvido com matérias-primas de alta performance, PRONTO PARA USO. Possui em sua formulação inibidores de corrosão na proporção adequada para a proteção dos metais do sistema de arrefecimento dos motores de veículos (gasolina/etanol/diesel/gnv) e motores estacionários. Prolonga a vida útil dos motores oferecendo excelente proteção contra a corrosão e cavitação..

• **MODO DE USAR:**

1.) Realizar a limpeza completa do sistema de arrefecimento, com água pura. 2.) Adicione o produto no sistema de arrefecimento, até completar o nível indicado no reservatório ou no radiador. **ATENÇÃO: O PRODUTO NÃO PRECISA SER DILUÍDO E PODE SER UTILIZADO PURO NO SISTEMA.**

CODIGO: 10669

ANTI CORROSIVO DIESEL CONCENTRADO



• **DESCRIÇÃO:**

O anticorrosivo para motores a diesel foi desenvolvido para evitar a corrosão, cavitação das camisas de pistão do sistema de arrefecimento de motores diesel.

• **MODO DE USAR:**

Esgote toda a água do radiador, limpar o sistema lavando com água limpa. Se a água estiver muito suja, utilizar um antiencrustante e preparar uma mistura de 1 litro do anticorrosivo para 24 litros de água. Repetir a limpeza do sistema de refrigeração a cada 60 mil quilômetros ou a cada 3 meses..

1 LITRO CODIGO:10670

ÁGUA DESMINERALIZADA



• **DESCRIÇÃO:**

A água desmineralizada, também conhecida como deionizada, é quimicamente pura, ou seja, livre de íons, minerais e metais pesados. Possui as mesmas características e benefícios da água destilada, diferenciando-se apenas pelo processo de obtenção.

• **MODO DE USAR:**

Adicionar o conteúdo deste frasco conforme recomendação do fabricante do sistema.

1 LITRO CODIGO:9765



Disponível em
5 Litros e
20 Litros

NEOKLON



SILICONE NEUTRO PRETO ALTA TEMPERATURA 85G

- **DESCRIÇÃO:**
Adesivo Silicone Neutro de última geração, considerado um dos melhores do mercado. Recomendado para automóveis, tratores e caminhões de última geração.
- **VANTAGENS:**
Resistente a água, óleos líquidos refrigerantes, óleos de transmissão e fluidos hidráulicos. Não oxida, forma juntas elásticas de longa duração, não danifica dispositivos elétricos, circuitos eletrônicos e sensores de medição e sensores catalíticos.
- **TEMPERATURA:**
 - 265° Uso contínuo
 - 315° Uso intermitente

CODIGO: 10685

NEOKLON



SILICONE NEUTRO CINZA ALTA TEMPERATURA 85G

- **DESCRIÇÃO:**
Adesivo Silicone Neutro de última geração, considerado um dos melhores do mercado. Recomendado para automóveis, tratores e caminhões de última geração.
- **VANTAGENS:**
Resistente a água, óleos líquidos refrigerantes, óleos de transmissão e fluidos hidráulicos. Não oxida, forma juntas elásticas de longa duração, não danifica dispositivos elétricos, circuitos eletrônicos e sensores de medição e sensores catalíticos.
- **TEMPERATURA:**
 - 265° Uso contínuo
 - 315° Uso intermitente

CODIGO: 10686

NEOKLON



SILICONE NEUTRO PRETO ALTA TEMPERATURA 50G

- **DESCRIÇÃO:**
Adesivo de silicone neutro mais utilizado do mercado. 100% polímero de silicone. Recomendado para carros novos que tem catalisadores e injeção eletrônica. Ideal para vedar superfícies submetidas a altas temperaturas.
- **VANTAGENS:**
Excelentes propriedades físicas, forma uma junta durável, flexível e resistente..
- **TEMPERATURA:**
 - 205° Uso contínuo
 - 336° Uso intermitente

CODIGO: 3736

NEOKLON



SILICONE NEUTRO CINZA ALTA TEMPERATURA 50G

- **DESCRIÇÃO:**
Adesivo de silicone neutro mais utilizado do mercado. 100% polímero de silicone. Recomendado para carros novos que tem catalisadores e injeção eletrônica. Ideal para vedar superfícies submetidas a altas temperaturas.
- **VANTAGENS:**
Excelentes propriedades físicas, forma uma junta durável, flexível e resistente..
- **TEMPERATURA:**
 - 205° Uso contínuo
 - 336° Uso intermitente

CODIGO: 3735



SILICONE NEUTRO VERMELHO ALTA TEMPERATURA 50G

- **DESCRIÇÃO:**
Adesivo de silicone neutro mais utilizado do mercado. 100% polímero de silicone. Recomendado para carros novos que tem catalisadores e injeção eletrônica. Ideal para vedar superfícies submetidas a altas temperaturas.
- **VANTAGENS:**
Excelentes propriedades físicas, forma uma junta durável, flexível e resistente..
- **TEMPERATURA:**
 - 265° Uso contínuo
 - 315° Uso intermitente

CODIGO: 9759



SILICONE INCOLOR 50G

- **DESCRIÇÃO:**
Silicone para uso geral. Selante 100% transparente e resistente ao mofo. Tem adesão em laminados de fórmica, telhas cerâmicas, fibras de vidro, plásticos, granitos, vidros, metais e louças.
- **MODO DE USAR:**
A superfície deve estar limpa e seca. Se necessário, faça uma máscara com fita adesiva para delimita o local de aplicação. Aplique o silicone em ambos os lados do encaixe. Se necessário, alise imediatamente o produto. Em 30 minutos o produto estará mais pegajoso ao tato. Normalmente cura em 24 horas.

CODIGO: 9760



TRAVA QUIMICA ALTA RESISTENCIA

- **DESCRIÇÃO:**
Uma vez aplicado, o produto cria uma junta com alta resistência a choques e vibrações, e ainda com excelente capacidade de resistência à itens químicos e solventes.
- **MODO DE USAR:**
A superfície deve estar limpa, seca e isenta de pó, graxa ou óleo. Aplique a quantidade suficiente para preencher os espaços entre as peças e promover a fixação e aguardar 60 minutos antes de colocar o equipamento em operação.

10G CODIGO:3959
50G CODIGO:3960



TRAVA ROLAMENTOS 10G

- **DESCRIÇÃO:**
Produto que impede a corrosão e vazamento do conjunto de fixação, érecomendado principalmente para fixação de peças cilíndricas como buchas, rolamentos, chavetas, hélices que necessitam de alta resistência à desmontagem. Elimina folga dentro de conjuntos já gastos.
- **MODO DE USAR:**
Faça a limpeza das peças a fixas. Aplique o produto em uma das partes e faça a junção da outra parte, movimentando as peças para que seja assegurado o preenchimento. Tempo total de cura 12 horas. Para acelerar o tempo de cura utilize um ativador "T".

CODIGO: 3961

CiaBond



COLA JUNTA PARA MOTOR 75GR

• **DESCRIÇÃO:**

Para adesão e vedação de juntas de motores diesel, gasolina e álcool. Resistente à altas temperaturas e pressões.

• **MODO DE USAR:**

As superfícies deverão estar limpas, secas e livres de óleo ou graxa. Aplique o adesivo em ambas as superfícies a serem coladas, então espere entre 5 e 10 minutos para fazer a junção das partes. Superfícies semiporosas podem requerer mais que uma demão do adesivo.

CODIGO: 9329

CiaBond



VEDADOR LIQUIDO SEMI-SECATIVO 100GR

• **DESCRIÇÃO:**

Silicone para uso geral. Selante 100% transparente e resistente ao mofo. Tem adesão em laminados de fórmica, telhas cerâmicas, fibras de vidro, plásticos, granitos, vidros, metais e louças.

• **MODO DE USAR:**

Limpe o local a ser aplicado o produto, eliminando qualquer sujeira, tais como poeira, ferrugem, óleo ou graxa. Aplique o produto em ambas as peças a serem conectadas e aguarde 1 minuto para fazer a união das peças. O produto tem sua cura total após 24 horas. Não liberar o uso antes do prazo total da cura do vedante, isso compromete a qualidade de vedação do produto.

CODIGO: 9328

CiaBond



VEDA ESCAPAMENTO 100GR

• **DESCRIÇÃO:**

Produto desenvolvido para a vedação das junções dos escapamentos de automóveis. Resistente a vibrações e altas temperaturas.

• **MODO DE USAR:**

A superfície deverá estar limpa, seca e livre de óleo ou graxa. Aplicar o produto na quantidade necessária, ligar o motor e deixar secar normalmente pela própria temperatura do escapamento (tempo médio 5 minutos).

CODIGO: 9327

CiaBond



ADESIVO INSTANTANEO 5G

• DESCRIÇÃO:

Conhecida como "supercola", é multiuso, nem tão líquida nem tão espessa. Ideal para metais, papéis, madeiras, porcelanas, borrachas, plásticos etc.

• MODO DE USAR:

As superfícies devem estar limpas, sem óleo ou sujeira. Aplique uma fina camada de cola em apenas um dos substratos a serem fixados (o excesso prejudica o desempenho). Após aplicar a cola, mantenha as peças pressionadas por aproximadamente 20 segundos (até que as partes permaneçam no lugar). A cola atinge a máxima resistência em 24 horas.

CODIGO: 3973

CiaBond



ADESIVO INSTANTANEO 20G

• DESCRIÇÃO:

Conhecida como "supercola", é multiuso, nem tão líquida nem tão espessa. Ideal para metais, papéis, madeiras, porcelanas, borrachas, plásticos etc.

• MODO DE USAR:

As superfícies devem estar limpas, sem óleo ou sujeira. Aplique uma fina camada de cola em apenas um dos substratos a serem fixados (o excesso prejudica o desempenho). Após aplicar a cola, mantenha as peças pressionadas por aproximadamente 20 segundos (até que as partes permaneçam no lugar). A cola atinge a máxima resistência em 24 horas.

CODIGO: 3974

CiaBond



ADESIVO EPOXI 10MIN 20GR

• DESCRIÇÃO:

Adesivo à base de epóxi para uso profissional e doméstico. O uso mais frequente do produto é para a colagem de azulejo, vidro, madeira, concreto, a maioria dos plásticos rígidos, borracha vulcanizada, fibras naturais, pedras, metais e outros materiais.

• MODO DE USAR:

Limpe as superfícies deixando-as isentas de gordura, oxidação e tinta remanescente. Coloque na base que acompanha a embalagem, em partes iguais do conteúdo das duas bisnagas. Misture até obter uma pasta homogênea..

CODIGO: 9330

COLA TITANIUM PRO SERINGA DUPLA 25ML/25G

• DESCRIÇÃO:

TITANIUM PRO: Cola Epoxi bi-componente. Prático, sem risco de erro de dosagem. Manuseio das peças possível em 5 minutos, livre de solventes com alto poder de adesão, resistência mecânica e química. Preto após a cura. Alto poder de colagens de pequenas superfícies lisas, porosas ou irregulares.

• VANTAGENS:

- Epoxi Bicomponente. Cor preto após a cura.
- Formulado para reparos em superfícies duras, preenchimento de trincas e fissuras em ferro, aço, inox, madeira e até em granitos.
- Sem cheiro após cura.
- Alta viscosidade, não escorre.
- Endurece em 10 min.
- Cura total em 8 horas.
- Forte resistência.
- Após cura pode ser lixado, furado, usinado, pintado.
- Suporta Alta Temperatura constante até 150°C.
- Uso profissional, estocar em local com temperatura entre +5°C e 27°C em caixa lacrada.



CODIGO: 9774

RESTAURA TUDO SEM MANTA 190G



• DESCRIÇÃO:

O Kit de reparar de plásticos é um produto bi-componente formulado à base de resinas epóxi com excelente adesão. Indicado para para-choques, grades frontais, carenagens, faróis e materiais como: Fibra de vidro, metais, madeiras e plásticos.

• MODO DE USAR:

A peça a ser trabalhada deverá estar com a região a ser colada isenta de poeira, graxa ou óleo. Lixar a superfície grossa com lixa grossa ou lixadeira elétrica até obter abertura em "V" de 4 a 6 mm para a penetração do adesivo. Misturar a resina com o endurecedor em partes iguais (1:1 em volume) durante um minuto. Aplicar o adesivo na peça e aguardar a secagem à temperatura ambiente por quatro horas ou para acelerar a cura, colocar lâmpada de aquecimento ou manter a peça em estufa a 70° C durante 30 minutos. Lixar o excesso de adesivo, aplicar fundo e pintar a peça.

CODIGO: 8047

RESTAURA TUDO COM MANTA 190G



• DESCRIÇÃO:

O Kit de reparar de plásticos é um produto bi-componente formulado à base de resinas epóxi com excelente adesão. Indicado para para-choques, grades frontais, carenagens, faróis e materiais como: Fibra de vidro, metais, madeiras e plásticos.

• MODO DE USAR:

A peça a ser trabalhada deverá estar com a região a ser colada isenta de poeira, graxa ou óleo. Lixar a superfície grossa com lixa grossa ou lixadeira elétrica até obter abertura em "V" de 4 a 6 mm para a penetração do adesivo. Misturar a resina com o endurecedor em partes iguais (1:1 em volume) durante um minuto. Aplicar o adesivo na peça e aguardar a secagem à temperatura ambiente por quatro horas ou para acelerar a cura, colocar lâmpada de aquecimento ou manter a peça em estufa a 70° C durante 30 minutos. Lixar o excesso de adesivo, aplicar fundo e pintar a peça.

CODIGO: 8563



Vantagens em usar o RESTAURATUDO:

- Cola muitos materiais;
- Cola muito bem;
- Tempo de trabalho flexível;
- Não escorre;
- Serve para preenchimento;
- Serve para reforço;
- Resistente à água;
- Não corrói/reage pouco com os materiais de acabamento.



Rua das Flores, Nº138 Qd. 132 Lt. 12
Parque Oeste Industrial, Goiânia- GO
62 3300-1670

Volume 1